

Electric Machines Tutorials for NX-Magnetics

Dr. Binde Ingenieure

January 2, 2024

2011-2025 Dr. Binde Ingenieure, Design & Engineering GmbH. All Rights Reserved. This software and related documentation are proprietary to Dr. Binde Ingenieure, Design & Engineering GmbH. All other trademarks are the property of their respective owners.

DR. BINDE INGENIEURE, DESIGN & ENGINEERING GMBH MAKES NO WARRANTY WHATSOEVER, EXPRESSED OR IMPLIED THAT THE PROGRAM AND ITS DOCUMENTATION ARE FREE FROM ERRORS AND DEFECTS. IN NO EVENT SHALL DR. BINDE INGENIEURE, DESIGN & ENGINEERING GMBH BECOME LIABLE TO THE USER OR ANY PARTY FOR ANY LOSS, INCLUDING BUT NOT LIMITED TO, LOSS OF TIME, MONEY OR GOODWILL, WHICH MAY ARISE FROM THE USE OF THE PROGRAM AND ITS DOCUMENTATION.

THIS SIMULATION SOFTWARE USES FINITE ELEMENT METHODS. USERS SHOULD BE AWARE THAT RESULTS CAN HAVE UNPREDICTABLE ERRORS IF INPUT DATA IS NOT COMPLETELY CORRECT. THEREFORE ANY DESIGN DECISIONS SHOULD NOT BE BASED SOLELY ON THE SIMULATION. USE ADDITIONAL MEASUREMENTS TO ENSURE THE CORRECTNESS.

Contents

1	Techniques for Motion	4
2	Tutorial 1	6
2.1	Simple Rotor	6
2.1.1	2D Enforced Driver	7
2.1.2	2D Dynamic Driver	14
2.1.3	3D Enforced Driver	18
2.1.4	3D Dynamic Driver	26
3	Tutorial 2	28
3.1	Relay 3D, Translational Motion	28
4	Tutorial 3	40
4.1	Permanentmagnet Synchron Motor Analysis	40
4.1.1	Model Setup by AutoFEM	40
4.1.2	Find the Rotor Start Position for Maximum Torque	49
4.1.3	Analyze for Torque with Rotation	51
4.1.4	Analyze for Voltage in Phases	53
4.1.5	Parameter Optimization with HEEDS	55
5	Tutorial 4	64
5.1	AFEM Modeling of Motors	64
6	Tutorial 5	68
6.1	Asynchron (Induction) Motor Analysis	68
6.1.1	Basic Model Setup	69
6.1.2	Simulation at Fixed Speed	76
6.1.3	Sweep over Rotor Speed	83
6.1.4	Sweep with two Parameters	85
6.1.5	Thermal Analysis	87
6.1.6	Transient Run at Fixed Operating Point	91
6.1.7	Start of Motor	97
6.1.8	3D Model of Induction Motor	99
6.1.9	Post Processing	102
7	Tutorial 6	103
7.1	Motor (Team30) with Moving Band/Constant Rotor Shape (Conductor Motion)	103
7.1.1	Simulation with Moving Band	108
7.1.2	Post Processing	110
7.1.3	Solution with Conductor Motion	111
7.1.4	Post Processing	112
7.2	Motor (Team30_3D) with Conductor Motion	112

8	Tutorial 7	119
8.1	Motor Analysis in 3D by Sliding Motion	119
8.1.1	Properties for Sliding Surface	120
8.1.2	Properties for Periodicity Segments	121
8.1.3	The Rotor Joint Definition	122
8.1.4	Recommendations for Meshing	124
8.1.5	Solving and Post Processing	125
9	Tutorial 8	127
9.1	Motor Analysis in 3D by General Motion	127
10	Tutorial 9	134
10.1	Electric Motor Analysis for NVH	134
11	References	150

1 Techniques for Motion

The MAGNETICS solver has five different types of motion techniques:

- 'General Motion (GM)': General Motion can be used for any kind of motion, e.g. translation or rotation in 3D, because a remeshing is performed for every step. The process is the following:
 1. An initial start solution is solved. The basic result 'Magnetic Vector Potential' is stored in an extra file (restart-file). Following this solution is referenced as step 0.
 2. The nodes and elements of the moving body are then moved, e.g. rotated or translated corresponding to the desired displacement step. In 3D scenarios, the air mesh is recreated using function 'Solid from Shell'. This function needs a 2D boundary mesh which typically goes over all parts and also over the boundary of the air volume. Therefore, we don't have 'Mesh Mating Conditions' between air and the parts. In 2D scenarios said 'Solid from Shell' meshing is superfluous, of course.
 3. In case of magneto dynamic solutions:

To capture dynamic effects (the time derivative) it is necessary for every solution time step (e.g. step 1) to include results from one time step prior (e.g. step 0), in order to form time derivatives. Therefore, each solution step uses the result of the prior solution (e.g. step 0) as start condition. This is done automatically inside the solver.
 4. In case of magneto static solutions:

No time derivative is necessary. Therefore, each time step is a simple magneto static analysis step.
 5. One time step is computed. Results can be as usual: Magnetic Flux Density, Force, Eddy Currents, Current Losses, Temperature and others. In case of dynamic solutions finally the Magnetic Vector Potential result is again stored in the restart file and referenced as step 0.
 6. These steps are repeated in a loop to perform the complete movement.
- 'Moving Band (MB)': This is capable for 2D rotation only. The process is the following:
 1. The user defines the outside and inside edge of the air gap. The system creates a tri mesh between them and updates this at each step.
 2. The nodes and elements of the moving body are then moved, e.g. rotated corresponding to the desired displacement step.
 3. These steps are repeated in a loop to perform the complete movement.
- 'Sliding Surface (SM)': Sliding Surface is very similar to 'Moving Band' but it is made for 3D rotation. Here the air gap is made of two surfaces sliding in circular way. The mesh between the two surfaces must be structured such that, if a movement step appears, all nodes can find a new partner node again.
- 'Conductor Motion, const Shape (CM)'. This feature models the effect of moving conductors, such as water. It can also be used for motors, if the rotor shape does not change while rotating. So, there must be no change in geometry to use this feature. This is the case for instance if water flows through a tube or some induction motor types.

- 'Frequency Motion (FM)': This feature is used for the analysis of induction motors. The principle works similar to the 'Conductor Motion, const Shape'.

2 Tutorial 1

2.1 Simple Rotor

In this tutorial we analyse a rotor that is moving between two permanent magnets. First we apply a forced speed of 5.000 turns per minute and then we analyse the free motion behaviour.

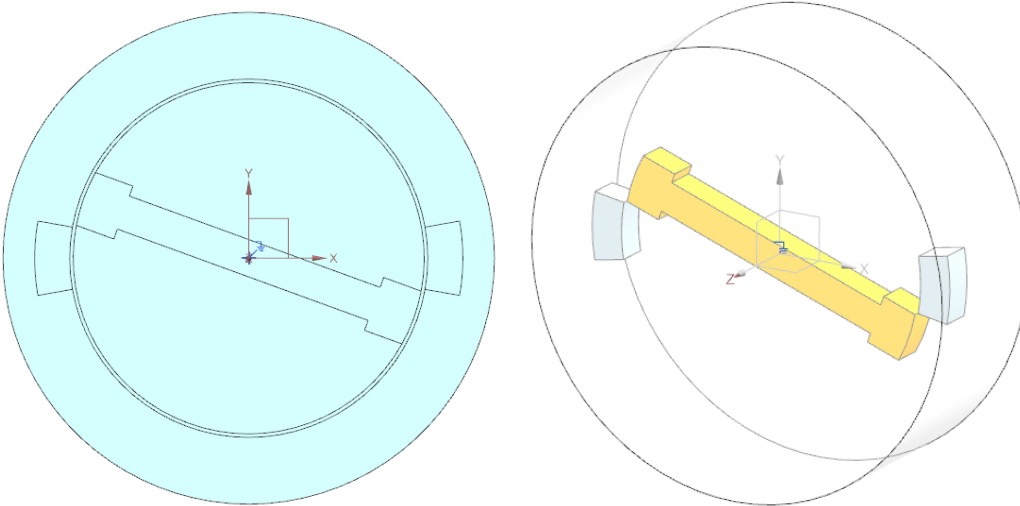

Different techniques are shown here, so we use 2D as well as 3D modeling. And we use two different motion techniques for rotation: 'General Motion', a feature that can be used for 3D rotation and translation. And the 'Moving Band' technique, that is capable for 2D rotation only. Also we show free (dynamic) motion as well as enforced motion. Thus, the tutorial is split into four parts:

1. 2D enforced,
2. 2D dynamic,
3. 3D enforced,
4. 3D dynamic.

Two permanent magnets are positioned near the rotor. This leads to time dependent variations of the magnetic field and therefore eddy currents will appear in all electric conducting parts. In reality such eddy losses will lead to temperature rise, an effect that is neglected in this basic tutorial but could be simulated by a coupled thermal solution. Those eddy currents shall be displayed and resulting power loss shall be computed. The enforced analysis shall be done over 45 degrees, the dynamic one over a time period that allows observing the expected oscillations. The CAD models of both the 2D and 3D base on the same 'Skelett.prt' file.

2.1.1 2D Enforced Driver

The following example is a pure 2D example; and thus not designed to work in 3D. In this example, an iron rotor rotates between two permanent magnets. The example shows how to perform analysis' that couple electromagnetics and mechanical movement. In the present scenario the motion is simulated with an enforced motion; however, it can also be simulated with dynamic motion. This is done in the next tutorial. Then, the movement would have one degree of freedom in the mechanical sense. The example is executed in 2D because of the shorter solution time but it would be similar in 3D as is shown in a further example.

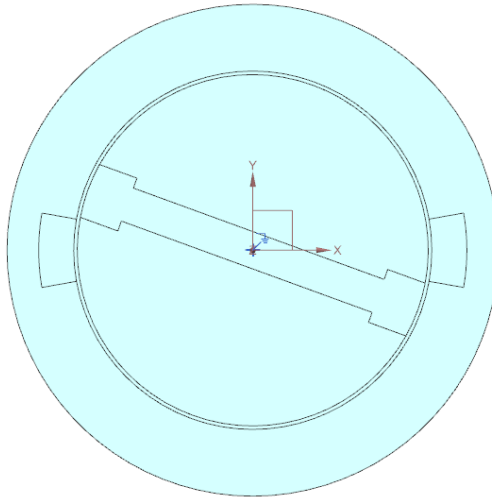

Main goal is to model the enforced motion effect of the rotor. Other results like eddy currents can be requested additionally if desired.

Estimated time: 45 min.

Follow the steps to reproduce it:

1. Download the model files for this tutorial from the following link:
<https://www.magnetics.de/downloads/Tutorials/6.CouplMotion/6.2SimpleRotor3D.zip>
2. Open the part file 'rotor2D.prt'.
 - Here, the start position of the rotor is set to -20 degrees.
 - Also, there is a 'Moving Band' visible. This has two circular edges, one connected to the moving part and one to the stator regions. At each time step the solver will rotate the moving regions and create a mesh between the two edges automatically.
3. Start Simcenter Pre/Post, create a new Fem and Sim file for 2D Electromagnetics.
 - Switch off 'Create Idealized File',
 - Choose Solver 'MAGNETICS' and Analysis Type '2D or axisym Electromagnetics', OK,
 - Set the 'Analysis Type' to 'Magnetodynamic Transient' and name the solution 'Enforced'.

- In register 'Output Requests', 'Table' activate 'Motion Data' and in 'Plot' activate 'Displacement' as well as 'Magnetic Fluxdensity'. Others can be activated if one is interested.

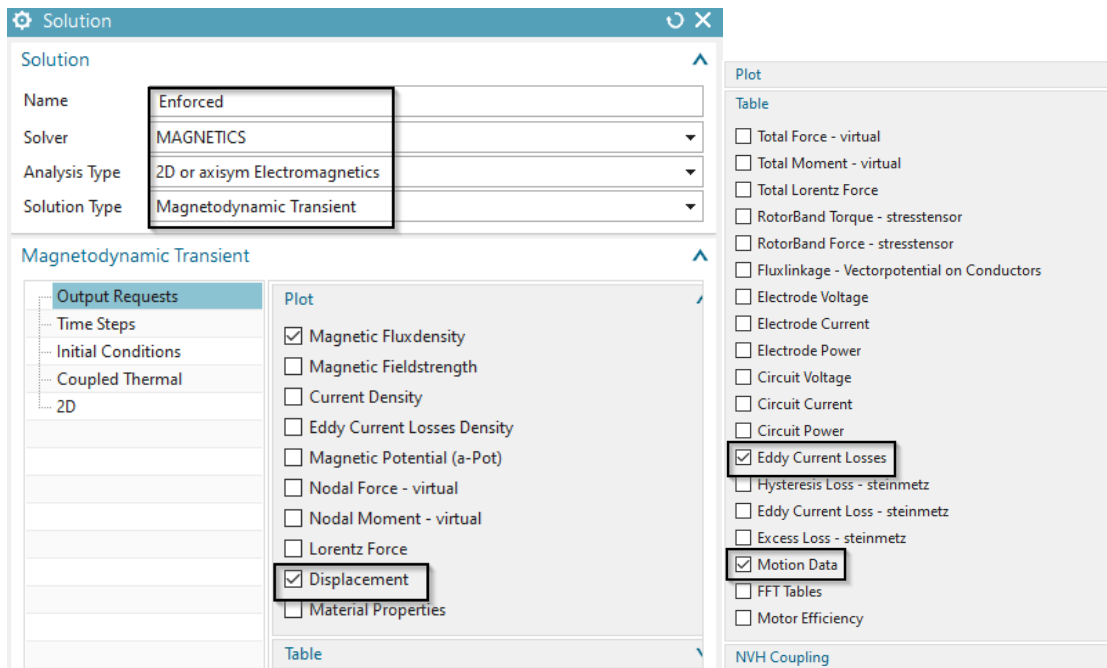

- In register 'Time Steps' set the 'Time Increment' to $1/(60 \cdot 360/60)$. This formula corresponds to a rotor speed of 60 rpm (1 rps).

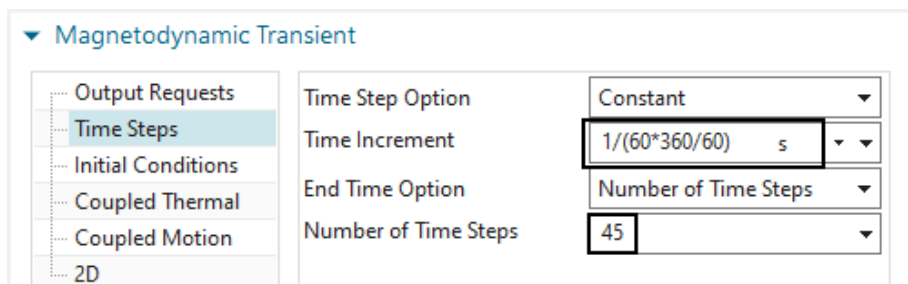

- In register '2D' set the 'Thickness' to 10 mm.

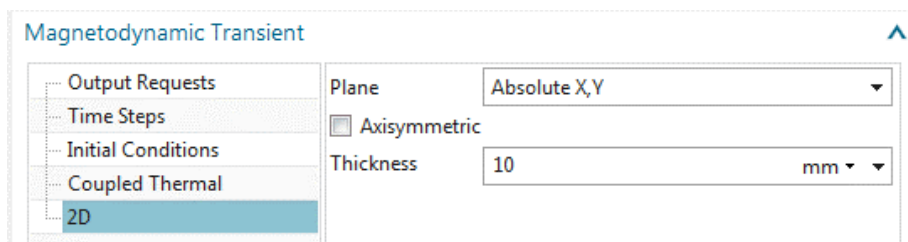

- OK.

4. Switch to the Fem File.

- When using the Moving Band technique the band elements should have about the same element size. Therefore, create a 'Mesh Control' , use type 'Size on Edge', select the outer and inner edges of the moving band, set the 'Element Size' to 1.5 mm

and click OK.

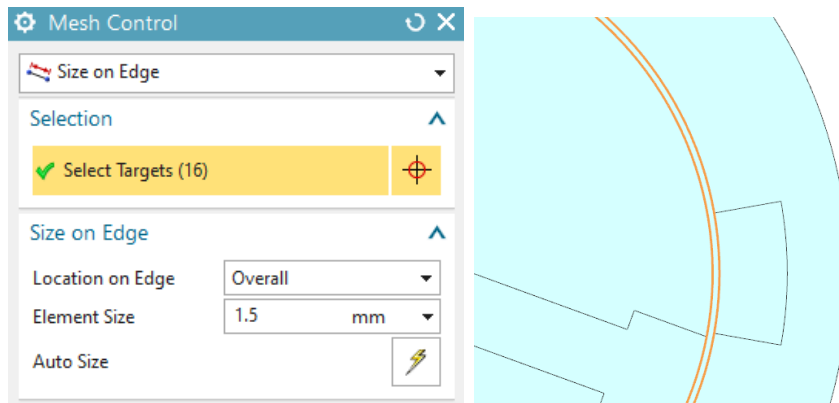

- Create a Tri-Mesh on the Magnets. Use the suggested element size and assign material 'N30EH at 100C'. The permanent direction of north is X by default, so we can stay with the default for our example. Assign the name 'Magnets'.

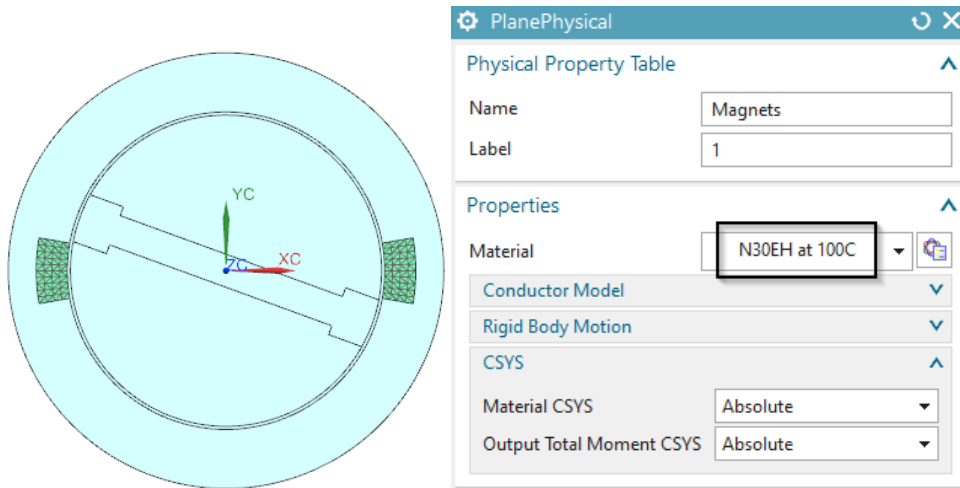

- For the Rotor also create a tri mesh with the suggested size and assign the material 'Iron_Sample1'. Also set the 'Inertia RZ' to ' 87 Kgmm^2 '. Assign the name 'Rotor_Iron'.

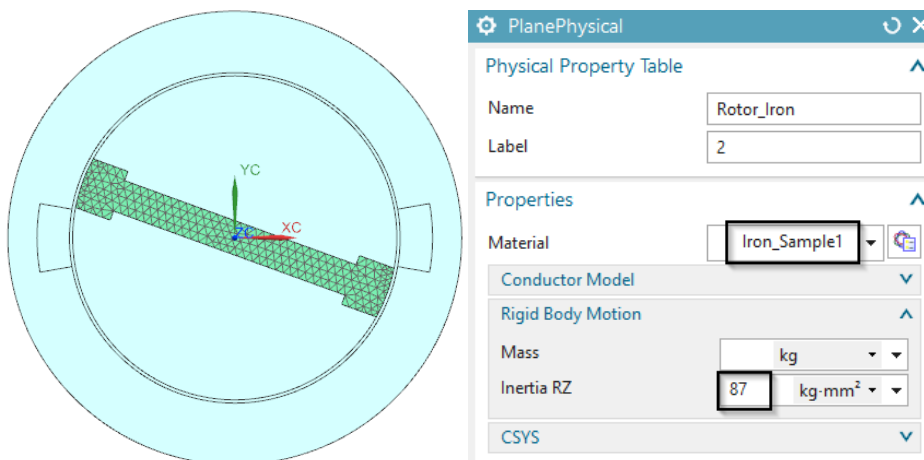

- For the inner air (2 faces) create a tri mesh with suggested element size and assign a 'FluidPhysical' with material 'Air'. Name it 'innerAir'.

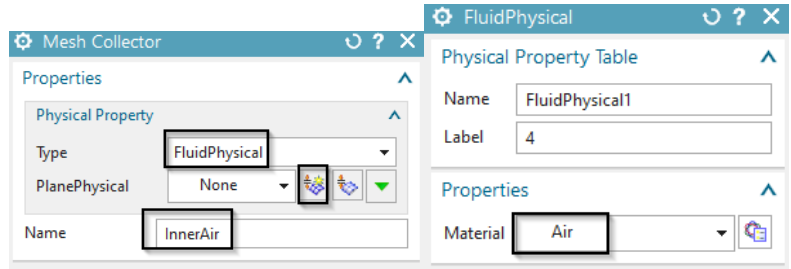
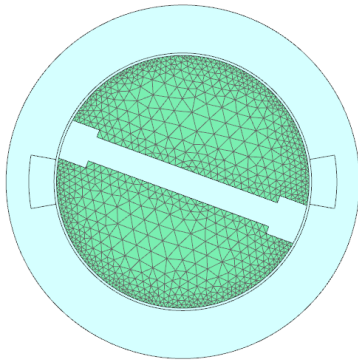

- For the outer air create a tri mesh and assign one more 'FluidPhysical' with material 'Air'. Name it 'outerAir'.

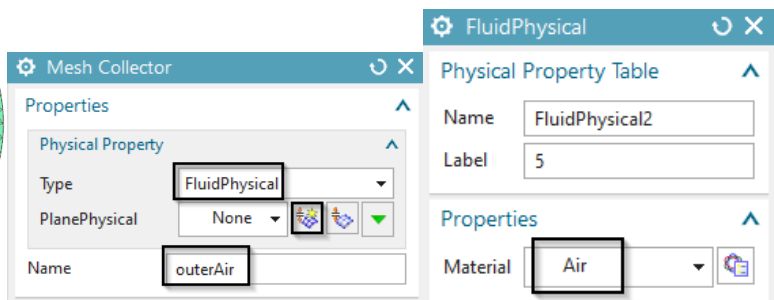
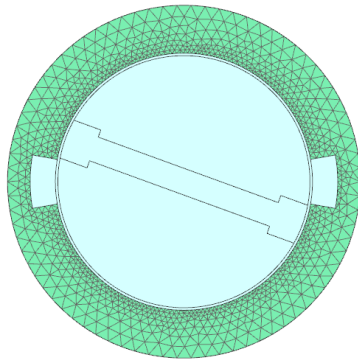

- Notice: Do NOT mesh the air gap between rotor and stator. When using the MovingBand feature this will be done automatically inside the solver.
- Check that all mesh collectors have a meaningful name. Then, click the button 'Rename Meshes and Physicals from Collectors' from the Magnetics toolbar.

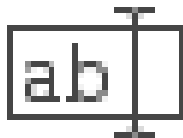
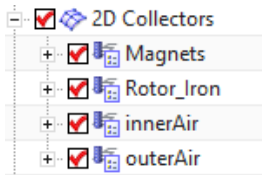

5. Switch to the Sim File.

6. Assign a constraint of type 'Flux tangent (zero a-Pot)' on the circular edge of the infinity air.

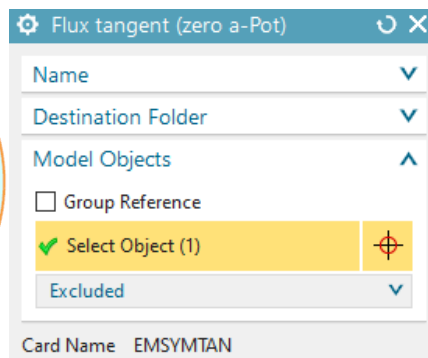
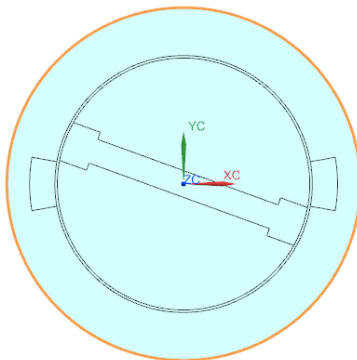

- Now create a new Simulation Object 'Enforced Motion 2D'. Use the type 'Revolute by Moving Band'. Hint: The type 'Revolute by General Motion' would also work, but this would use a different motion technique.

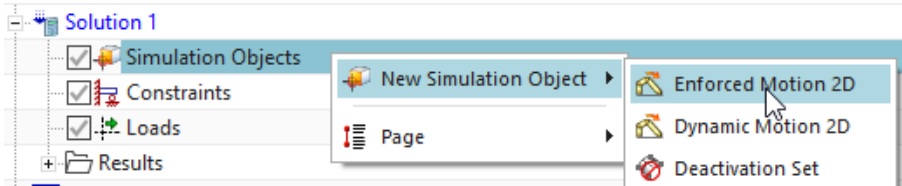

- At 'Airgap Rotor Edge' select the 8 inner circle edges as shown below. These must be those edges, that belong to the moving part. Maybe the selection filter with option 'Tangent Continuous Edges' is helpful here.

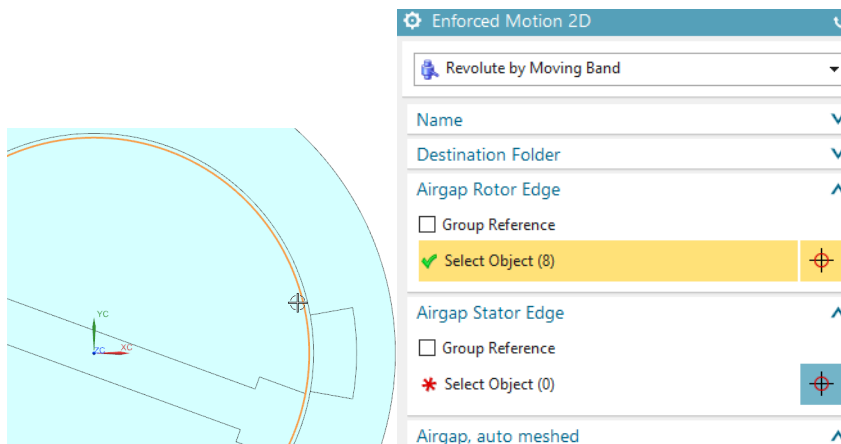

- At 'Airgap Stator Edge' select the 8 outer circle edges as shown below.

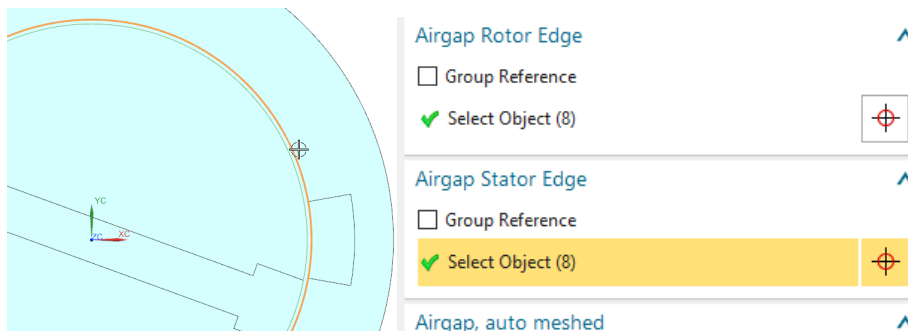

- Under the box 'Airgap, auto meshed' select from the list the Air, that already resides in the Fem file. Accept the default 1 at 'Number of Air Gaps'.

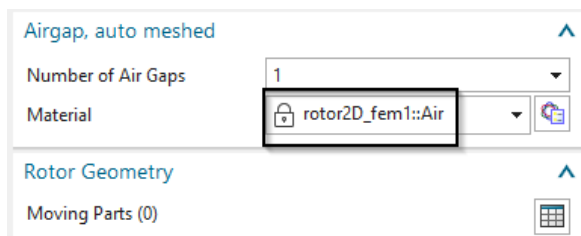

- Under 'Rotor Geometry', click 'Create Moving Parts'  and select the Rotor and the inner air and add these to the list. Then click 'Close' as shown below. If the names do not appear in the list take care that in the Fem file the Physicals have such

names assigned.

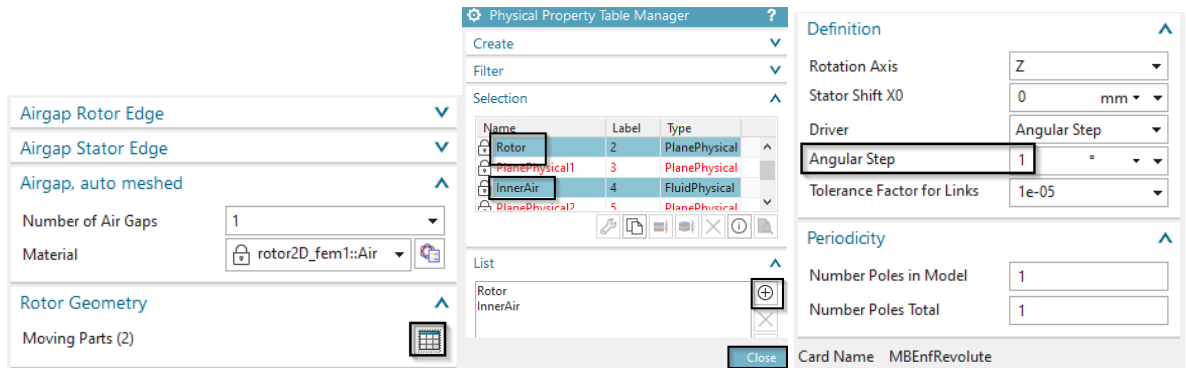

- At 'Angular Step' key in 1 deg. Because we have defined 45 time steps we will compute for 45 degrees of motion with these settings. OK.

8. Solve the solution. The solution monitor indicates the progress and successful end.

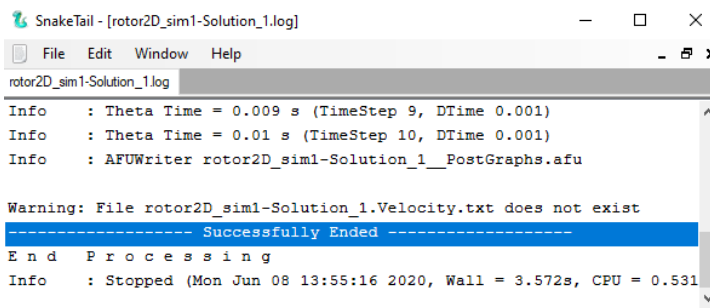

9. Plot the Magnetic Flux Density and observe the result. For a smoother display set the 'Combine At' option at 'Edit Post View' to 'Nodes' and at 'Average Across' deactivate 'PID'.

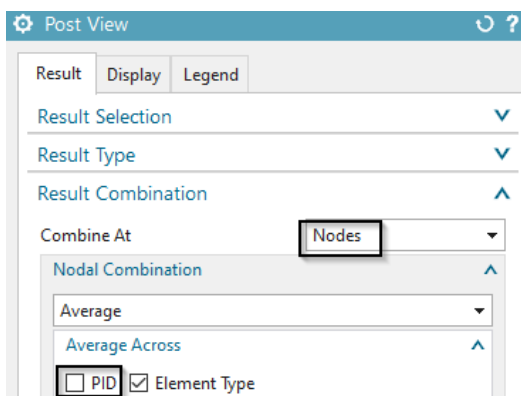

10. The plot with magnetic flux density, arrows and contour, then will look like the following for increment 1.

rotor2D_sim1 : Enforced Result
 Load Case 1, Initial Time Condition, 0s
 Magnetic Flux Density - Element-Nodal, Averaged, Magnitude
 Min : 0.000, Max : 1.097, Units = T
 Deformation : Displacement - Nodal Magnitude

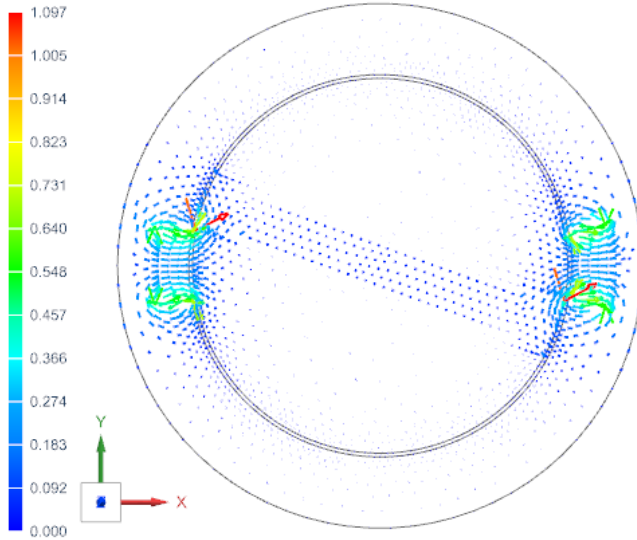

rotor2D_sim1 : Enforced Result
 Load Case 1, Increment 1, 0.0028s
 EddyCurrentLossesDensity - Element-Nodal, Averaged, Scalar
 Min : 6.398E-13, Max : 5.237E-05, Units = W/mm³
 Deformation : Displacement - Nodal Magnitude

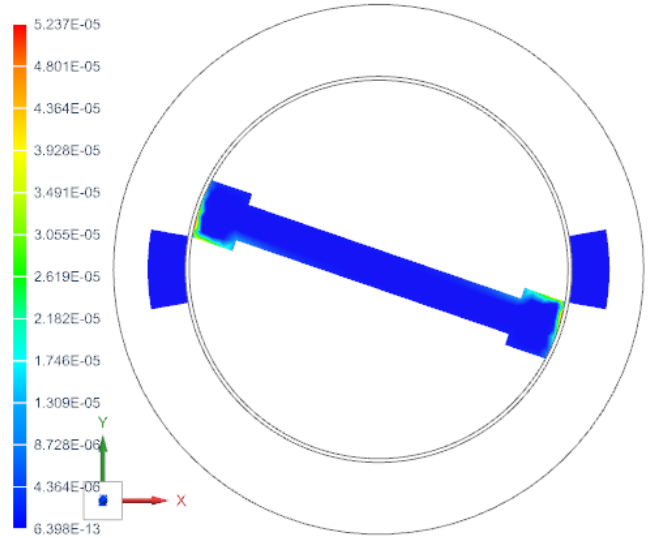

[7]

11. Cycle through the time steps by using the green button 'Next Iteration' . Alternatively, use the 'Animation' function and set the option 'Animate' to 'Iterations'. If you want to see more movement repeat the solution with more time steps.
12. Display the eddy current losses on the rotor. This graph shows nicely the eddy current effect when rotor and magnets move near to each other.

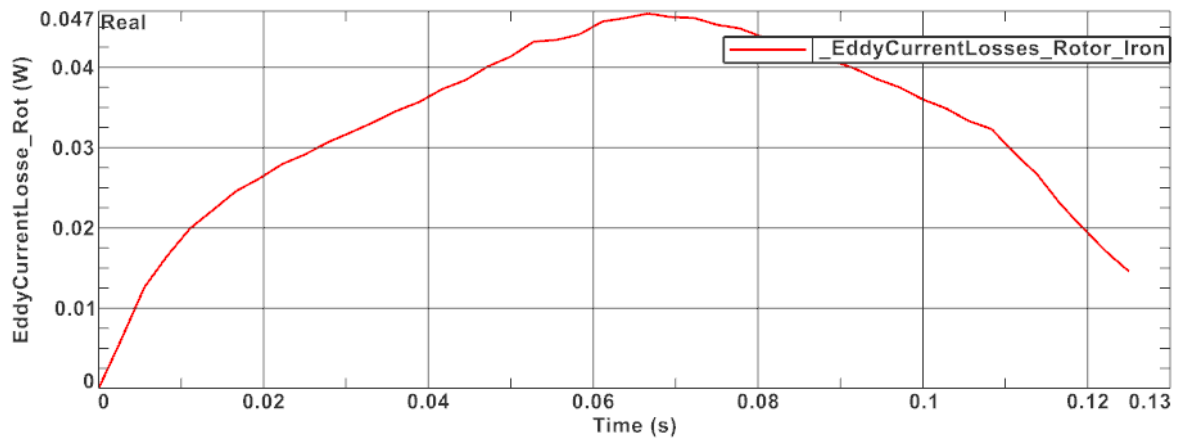

This ends the tutorial.

2.1.2 2D Dynamic Driver

The following example is a pure 2D example; and particularly is intended to be a follow-up example of the previous example 'Simple Rotor, Enforced'. In this example, the rotor oscillates between two permanent magnets. The example shows how to perform an analysis that couples electromagnetics and mechanical movement. In the present scenario the magnet is simulated with a dynamic motion. Here, the movement has one degree of freedom in the mechanical sense. The example is executed in 2D because of the shorter solution time but it would be quite similar in 3D.

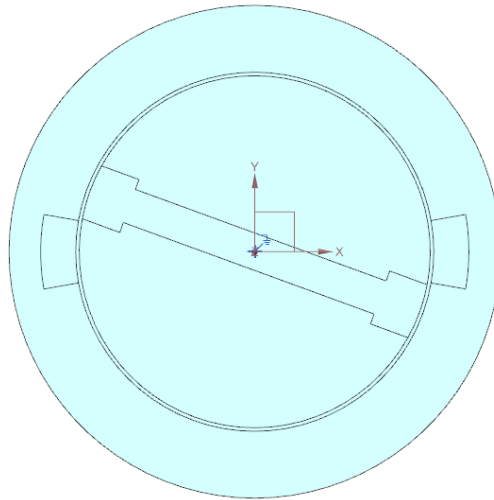

Main goal is to find the oscillation behavior of the rotator. Other results like eddy currents can be requested additionally if desired.

Estimated time: 25 min

Follow the steps to reproduce it:

1. Start from the previous example and clone the solution,

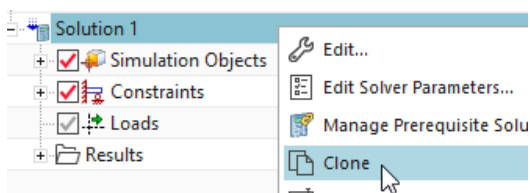

2. then remove the enforced joint.

3. Name the new Solution 'Dynamic'.

- Chose Analysis Type 'Magnetodynamic Transient'.
- In register 'Output Requests', Table activate 'Motion Data' and in Plot activate 'Displacement' as well as 'Magnetic Fluxdensity'. Others can be activated if desired.

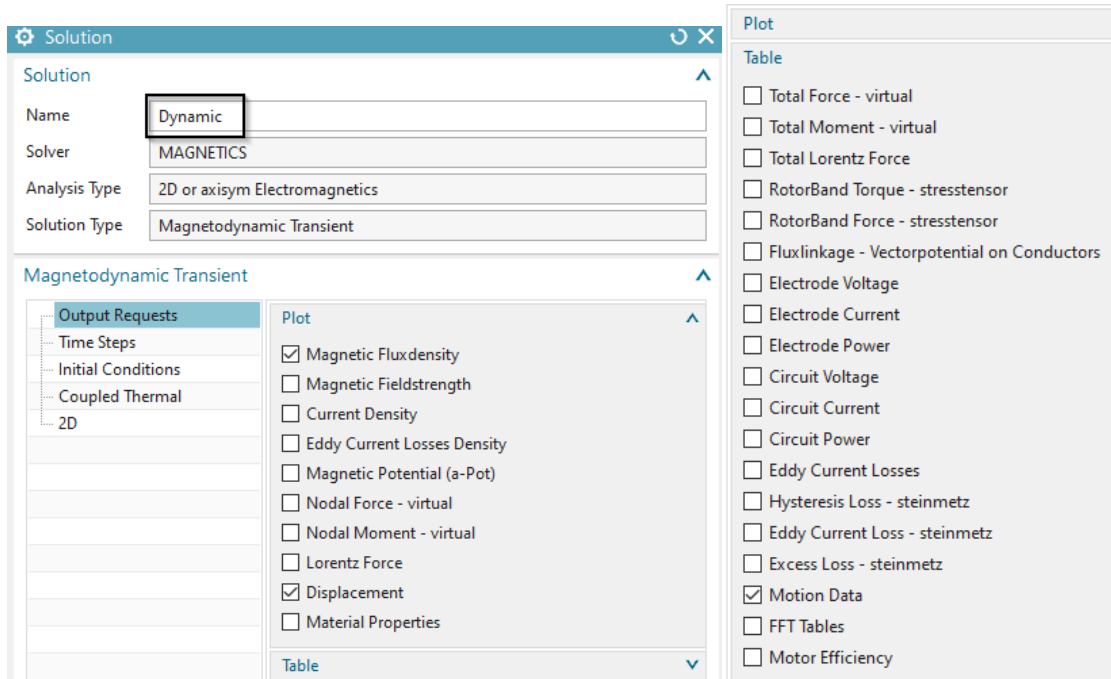

- Modify the 'Time Increment' to 0.001 and the 'Number of Time Steps' to 100 resulting in a total simulation time of 0.1 sec.

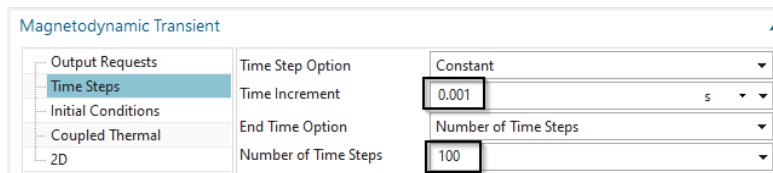

4. Change to the Sim file, if not already there.

- If a new solution is created, add the constrain 'Flux Tangent' to the solution.
- Create a 'New Simulation Object' of type 'Dynamic Motion 2D'. Remove the old one, if the solution was cloned.

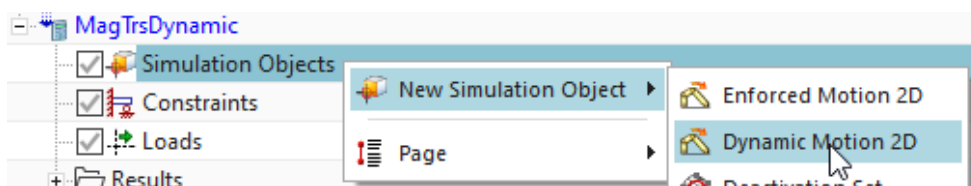

- Select Type 'Revolute by Moving Band' (the default)

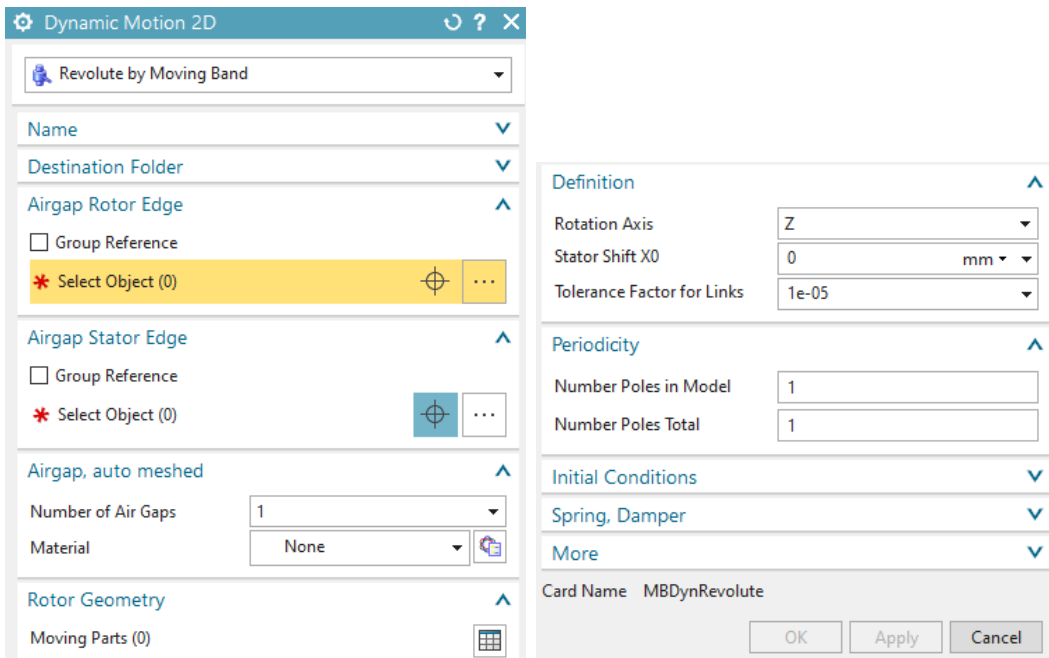

- Select the 'Airgap Rotor Edge' and the 'Airgap Stator Edge' in the same way as already done in the previous enforced example.

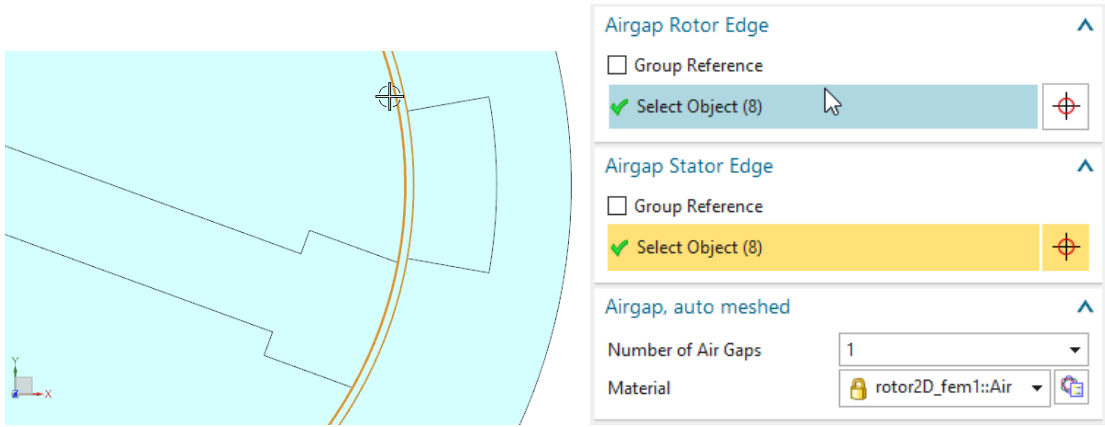

- Again select Air for the material at the Airgap

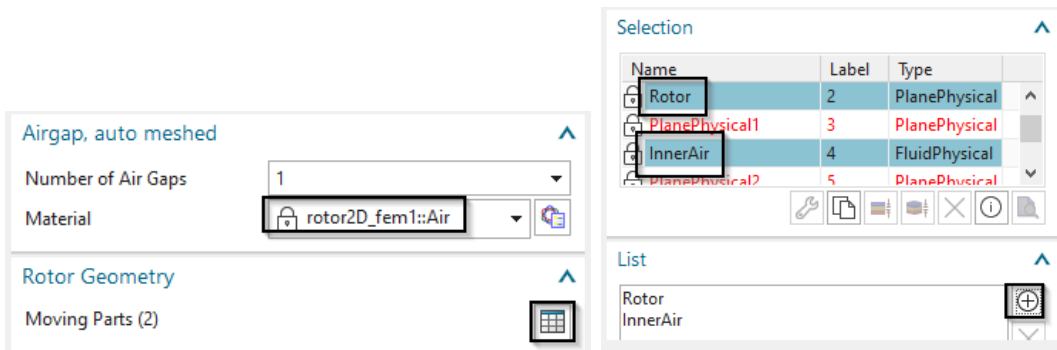

- At 'Rotor Geometry': Select the Rotor and the inner air.
- All other settings can stay at the defaults. There is no step size necessary because this will be computed from the dynamics of the system: Electromagnetic forces and mass inertia of rotor.

- Solve the Solution. This will take about 1 min.
- Now verify the oscillating behaviour of the rotor. To do so, open the results and display the 'Total Displacement' of the dynamic joint as in the below picture.

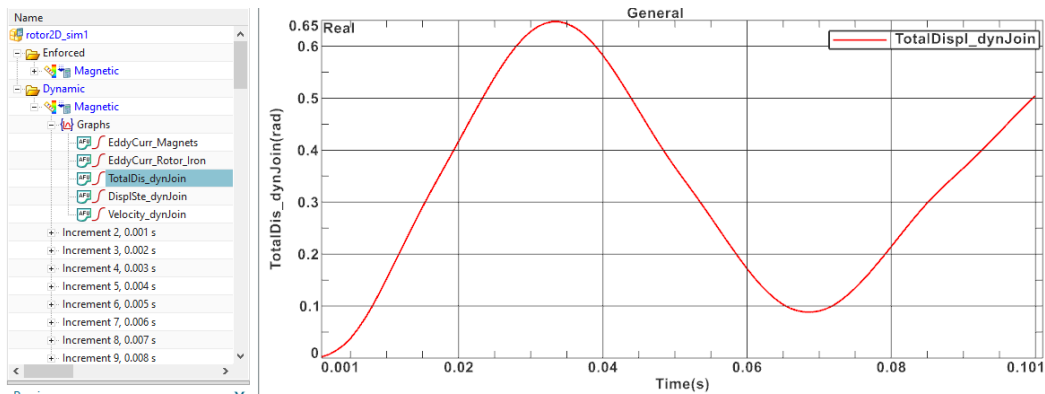

- Also plot the graph showing the eddy current losses on the rotor.

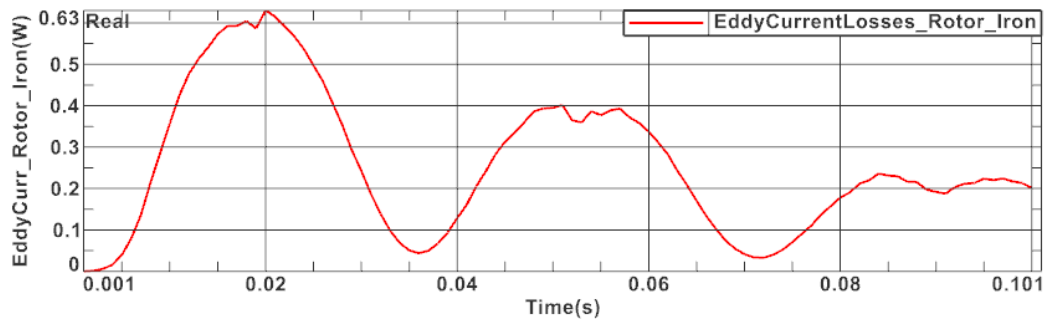

- Then plot the Magnetic Flux Density.

rotor2D_sim1 : Dynamic Result
 Load Case 1, Increment 8, 0.0080s
 Magnetic Flux Density - Element-Nodal, Unaveraged, Magnitude
 Min : 0.000, Max : 1.748, Units = T
 Deformation : Displacement - Nodal Magnitude

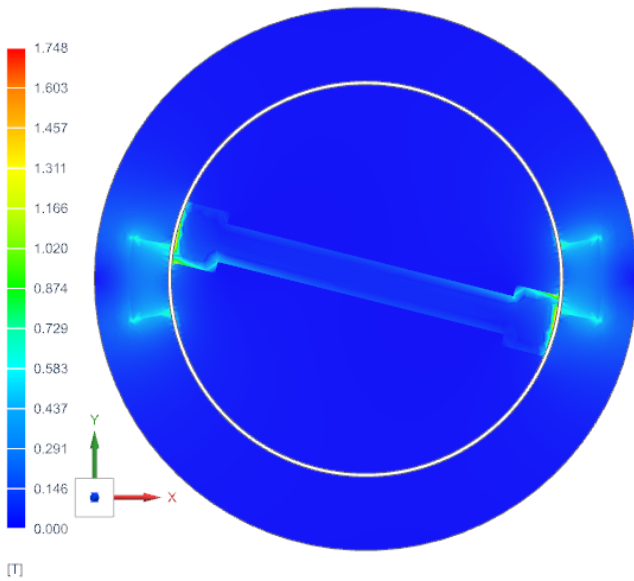

This ends the tutorial.

2.1.3 3D Enforced Driver

In this example we will use an enforced driver and 3D geometry.

Estimated time: 1 h. The following picture shows the geometry and the named CAD bodies.

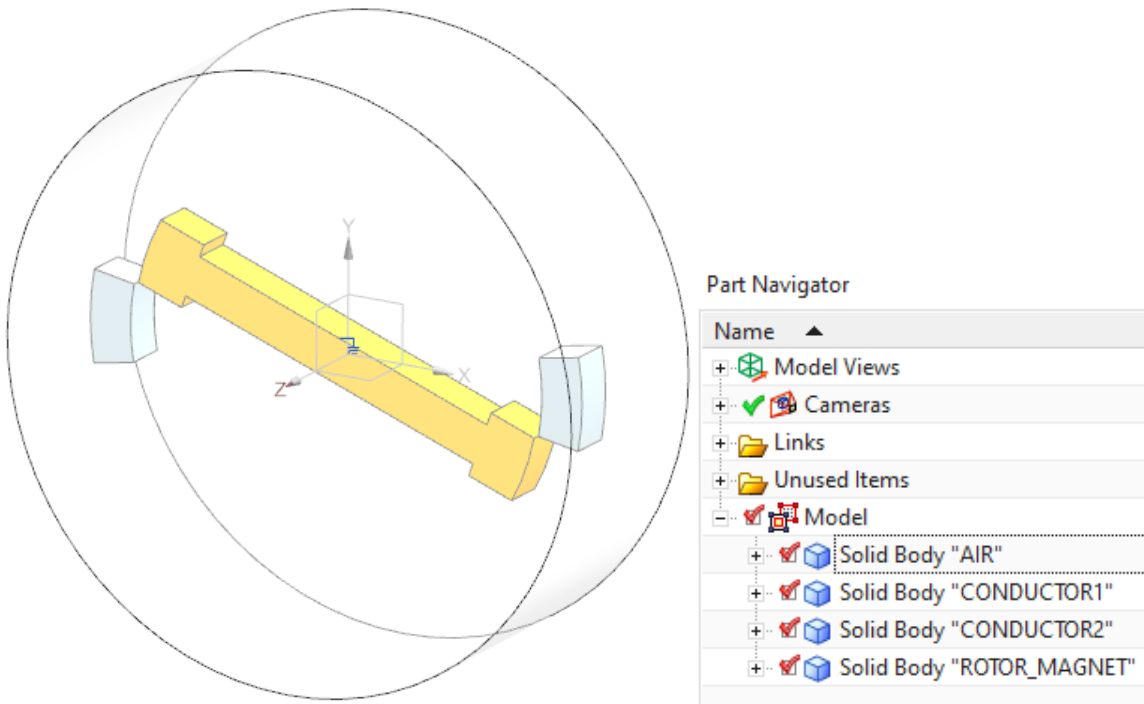

To set up the model, follow these steps:

1. Download the model files for this tutorial from the following link:
<https://www.magnetics.de/downloads/Tutorials/6.CouplMotion/6.2SimpleRotor3D.zip>
2. Open the file 'rotor3D.prt'.
3. Switch to Simcenter Pre/Post
4. Create a new FEM and Simulation. Choose Solver 'MAGNETICS' and Analysis Type '3D Electromagnetics'. Switch off the 'Create idealized Part'.
5. Choose Solution Type 'Magnetodynamic Transient'. Name the solution 'Enforced'.
 - In register 'Output Requests' under 'Plot' activate 'Current Density' and 'Eddy Current Losses Density' to enable the calculation of eddy currents. Also enable 'Nodal Force - virtual' to check for these results.
 - Under 'Table' activate 'Eddy Current Losses' to enable the calculation of integrated current losses and to get them written into a tabular file. Also enable 'Motion Data' to get results of displacement and velocity of the motion driver.

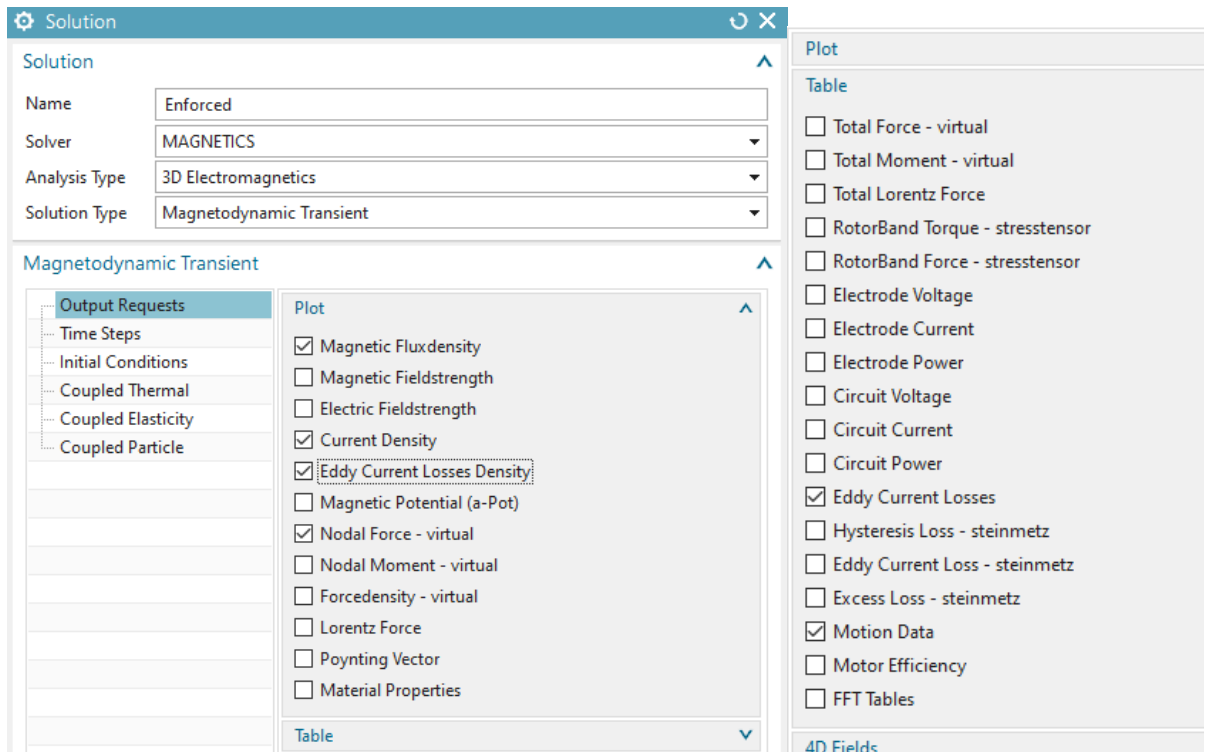

- In register 'Time Steps' set the 'Time Increment' as shown. This corresponds to a rotor velocity of 5.000 U/min if the step size is 1 deg. We will use this later.

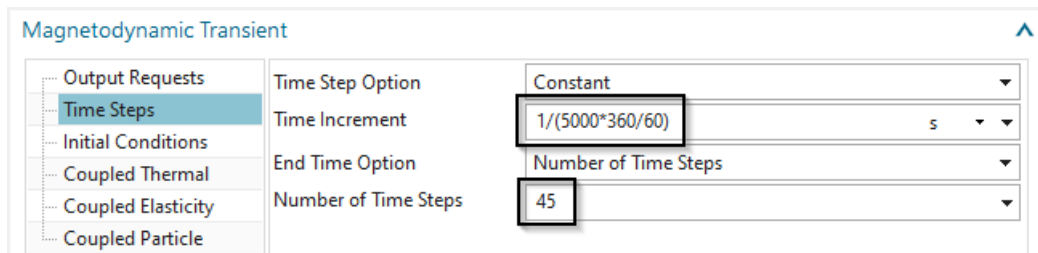

- In register 'Initial Conditions' accept the defaults. Hint: The option 'Set back after Solve' can be deactivated to allow restarting from a previous run.

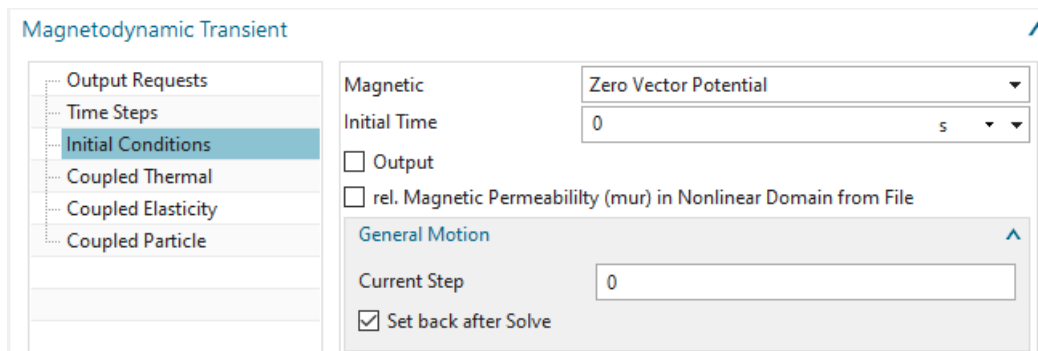

- Click Ok.

6. Switch to the Fem file.

7. Mesh the rotor:

- Use (3D) tetrahedral elements and the half of the suggested element size.

- Assign material 'Iron_Sample1' from the Magnetics material library.
- Key in the value 87 Kg mm^2 for Inertia RZ. This is necessary only in case of dynamic motion of the rotor because the forces acting on the rotor will be transformed into a motion step by Newtons law.
- name the collector 'Rotor_Iron', click OK to finish.

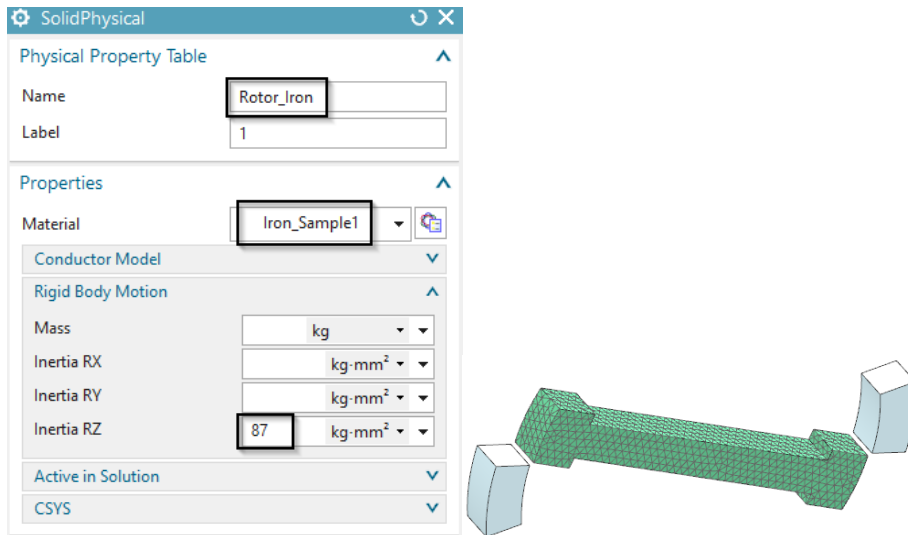

8. Mesh the two magnets:

- Use (3D) tetrahedral elements with half of the suggested element size.
- Assign material 'N30EH at 100C'. Name the collector 'Magnets'. OK. Hint: For the north direction, we want x. Because x is the default, there is nothing to do now.

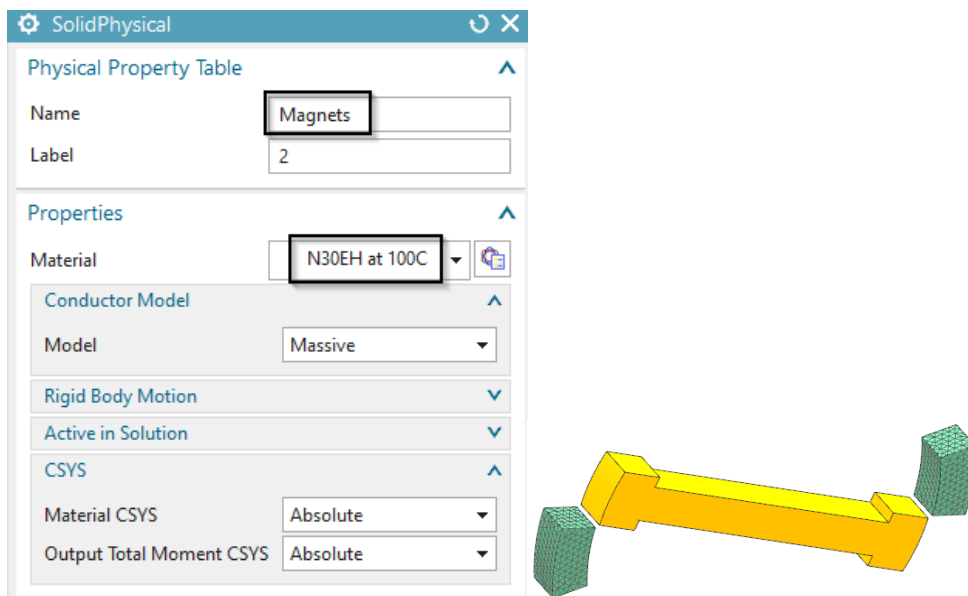

9. Mesh (2D) the three outside faces of the body 'AIR'.

- Use (2D) tri elements with a quarter of the suggested element size.

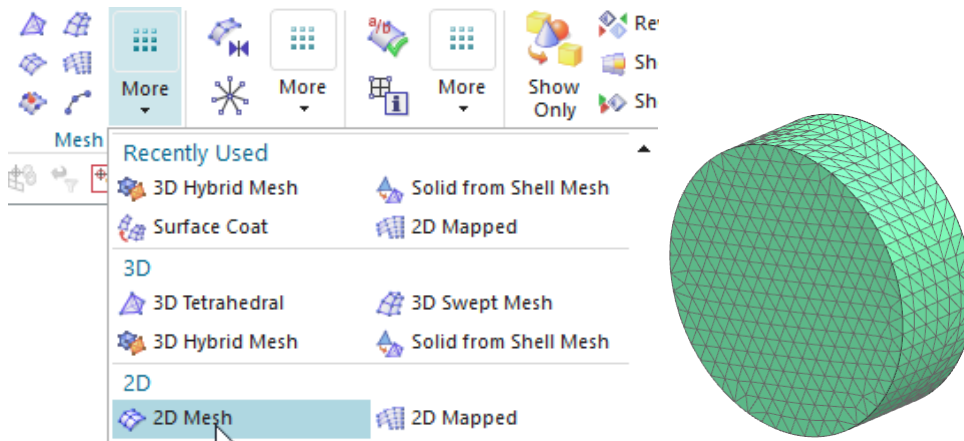

- In the mesh collector of this 2D mesh, set the Type to 'ZeroPotential' and click 'Create Physical...'. and OK. This setting will impose a boundary condition at the mesh level, so there is no need to give a zero potential condition in the Sim file.
- name the mesh collector 'Outer_ZeroPot_Meshes'. OK.
Notice: This 2D mesh will be used two times: First it serves as boundary condition and second it is used as border for the following air mesh (Solid-from-Shell Mesh).

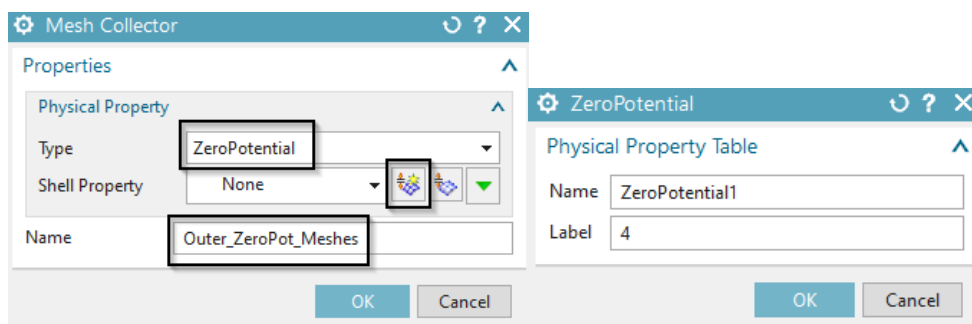

10. Now create 2D Surface Coat meshes on the parts:

- Blank the 2D meshes and also the air body.
- Choose the meshing function 'Surface Coat',

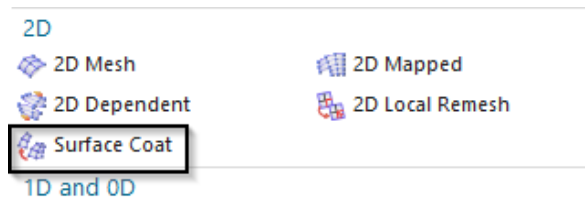

- Select the bodies of the two conductors and the rotor,
- Set the 'Mode' to 'Geometry', activate 'Export Mesh to Solver' and 'Automatic Creation', Check that the 'Type' is set to 'Tri'.

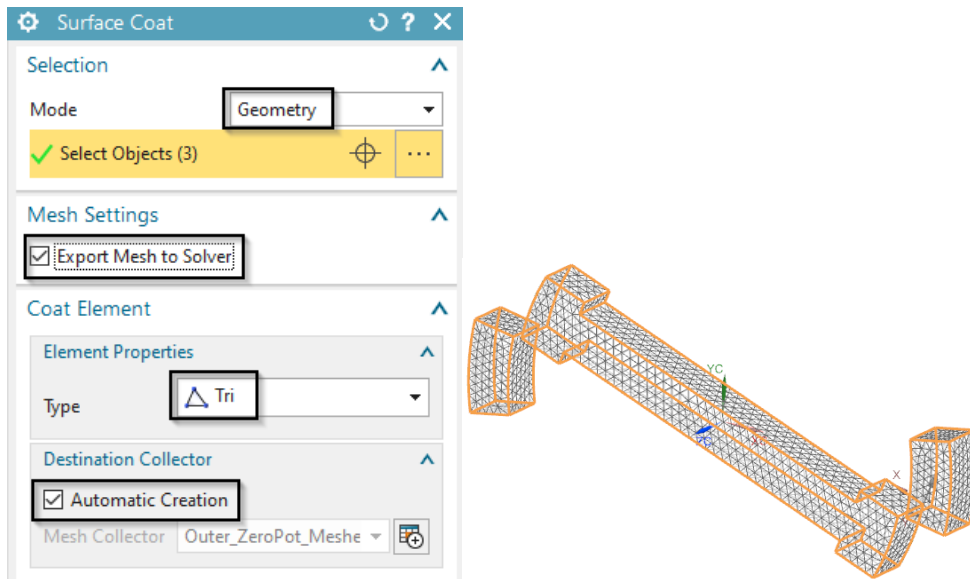

- The system creates by default a physical of type NotToSolver what is correct because we want to use these 2D meshes only as borders for the following air mesh (Solid-from-Shell Mesh).
- Assign the name 'Inner_Coat_Meshes' to this mesh collector.

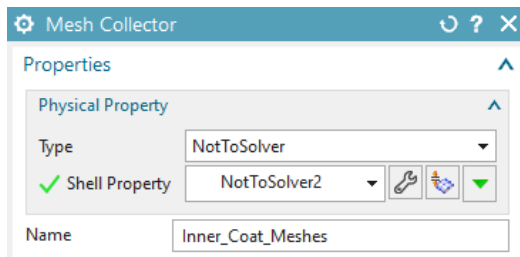

11. We want to have all collector names written to the corresponding physicals and meshes because this is easier to use. Therefore click the button 'Rename Meshes and Physicals from Collectors' from the Magnetics toolbar.

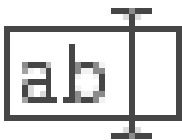

12. Next we create a new 3D mesh collector that will later hold the 3D air mesh. We will set up this collector in a way that it automatically updates the air mesh at every new rotor position. It will automatically use the 'Solid from Shell' mesher, therefore it is necessary to have meshed the 2D border of this 3D air.

- First choose the function to create a new collector. Name this collector 'UpdatingAirMesh'.

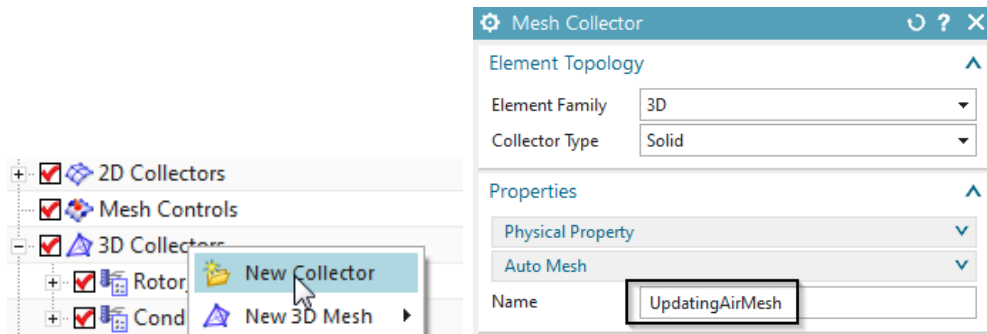

- In box 'Physical Property' set the 'Type' to 'FluidPhysical'. Use the button 'Create Physical' to create a new physical. In the new physical choose the material Air. OK.

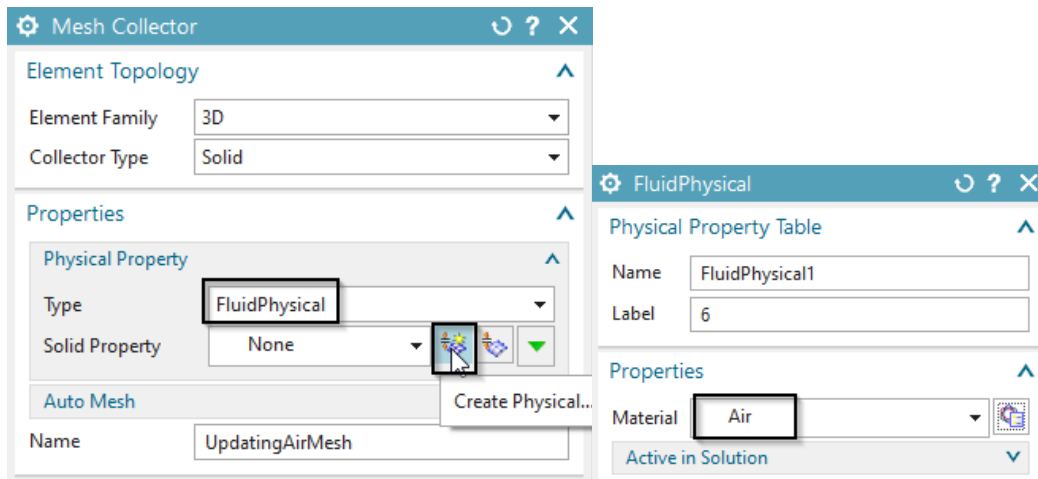

- Back in the mesh collector dialogue expand the box 'Auto Mesh' and set the option 'Activate' to 'Auto Mesh at Solve'.
- Next choose the button 'Shell Boundary for 3D Mesh'. In the following dialogue select the two border physicals and click on 'Add'.
- Then press Close and Ok to close all dialogues.

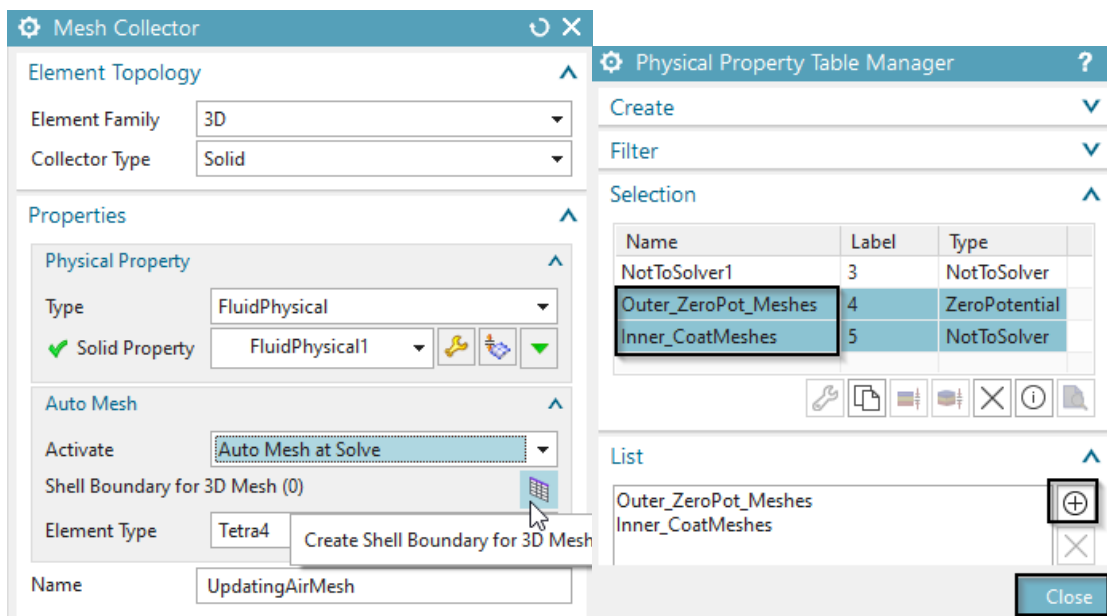

- The navigator now shows the new collector. Notice that there is no mesh in it. This mesh will be created at solve time automatically through the function 'Solid from Shell Mesh'. The mesh will also be updated at every motion step.

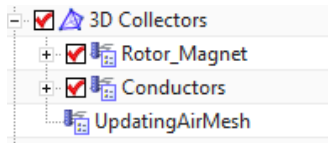

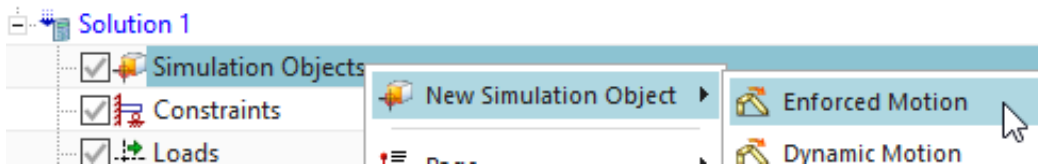

13. Switch to the Sim-file.

14. Create 'Simulation Object' for the rotor movement:

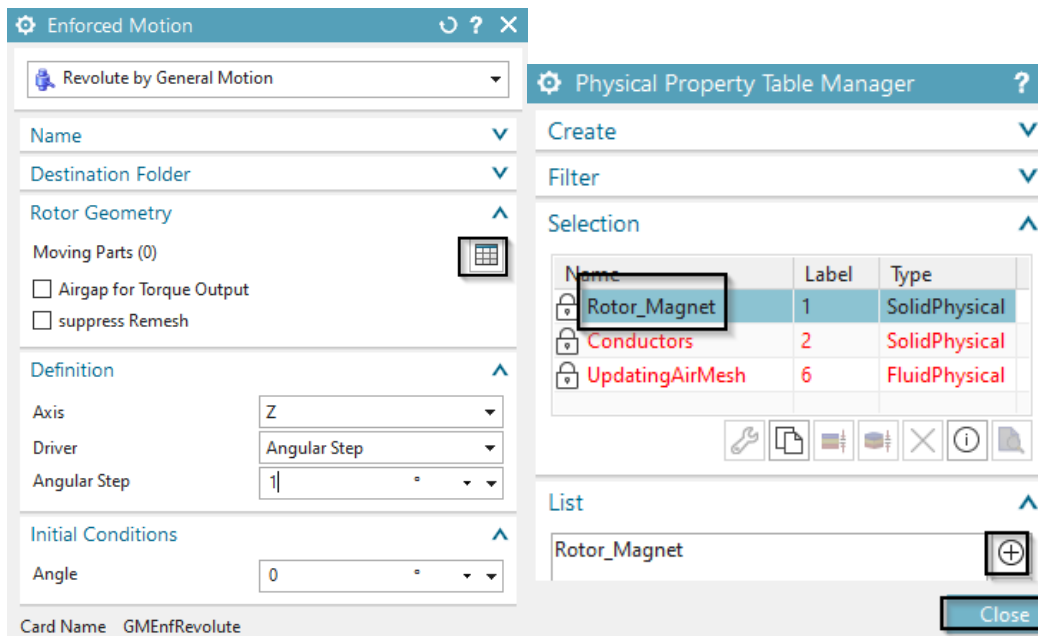

- Choose the function 'Enforced Motion'. The following dialogue appears



- At 'Rotor Geometry' click on 'Create Moving Parts' . In the following dialogue select the physical Rotor_Magnet and click Add, Close.
- Notice that the 'Angular Step' is set to one degree for each step. This is already what we want so there is no change necessary. Leave all other settings at their defaults. OK.
- Hints: By this procedure the MAGNETICS Solver will rotate the 3D Rotor mesh at each timestep for the desired amount and will automatically create 'Solid from Shell' meshes for the air using the previously created 2D boundary meshes.

15. Model setup is now done. Save your parts, blank the meshes (maybe you leave the rotor mesh visible because this will nicely show the motion). Decrease the window size, because it will pop up to foreground at every time step.

16. Solve the solution. This will take 5-10 minutes because of the 45 steps to run. A progress bar at the bottom of the Simcenter window shows the current and the remaining steps.



17. The finishing of the solve is shown by the information window as below

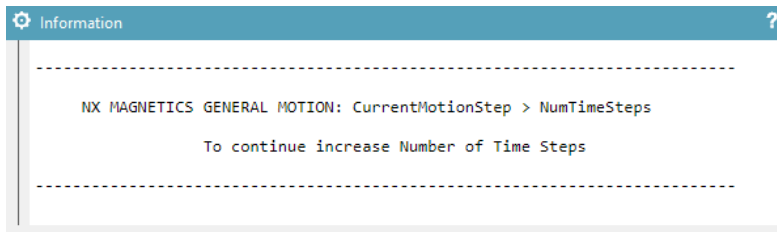

18. After the solve finishes you can post process the results.

- Open the plot results. All motion steps are stored in the result file. This allows running animations over the iterations and creating movies if desired.
- The following picture shows the magnetic flux density result (left) and the nodal forces (right) at time step 9. (Results are set to averaged at nodes and element edges are blanked).

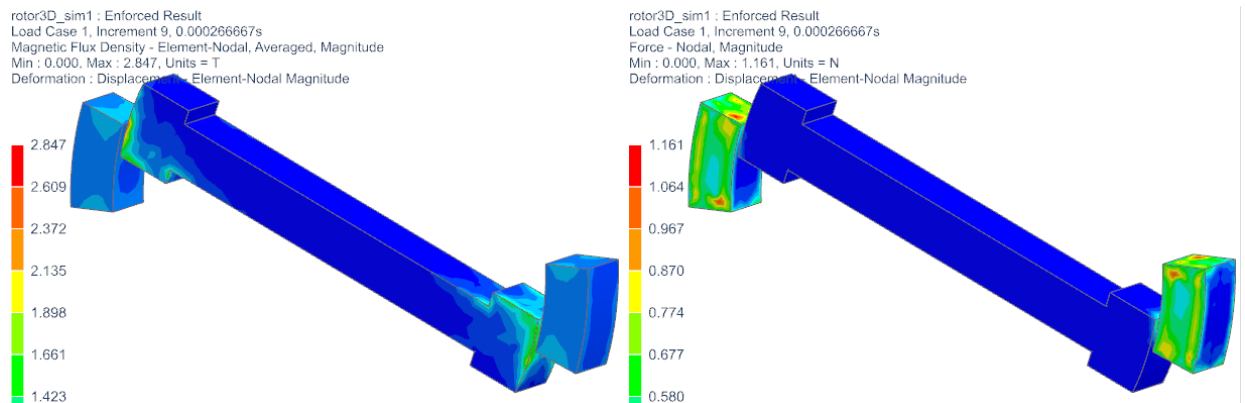

19. After this General Motion run the moving meshes are set to 'Locked'. If an update of the meshes to the original situation is desired, unlock the moving meshes and perform a mesh update.

The tutorial is complete.

2.1.4 3D Dynamic Driver

The completed Sim file, that resides in the tutorial folder, contains also a solution (named 'Dynamic') with a dynamic joint. This can be used for further studies. (Set the 'Number of Time Steps' to 100 before solving the complete period.) The following result graphs are made with a larger number of time steps. Of course, that solution needed much more time.

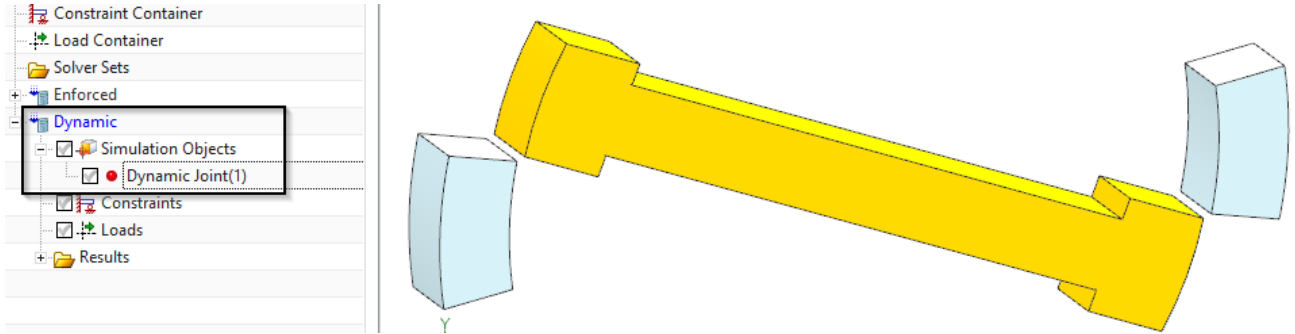

The following picture shows the resulting displacement of the previous 2D dynamic (blue) and the 3D dynamic (red) rotor.

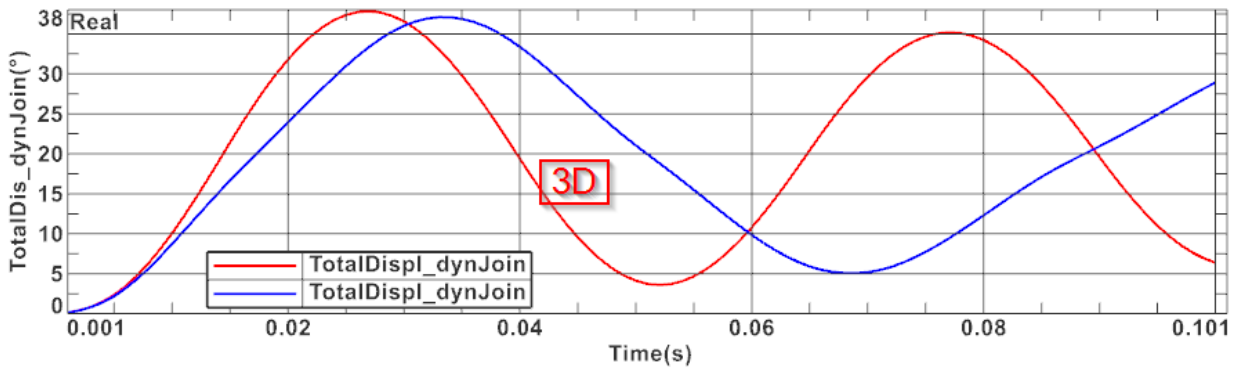

The next picture shows the resulting eddy current losses of the 2D dynamic (blue) and the 3D dynamic (red) rotor.

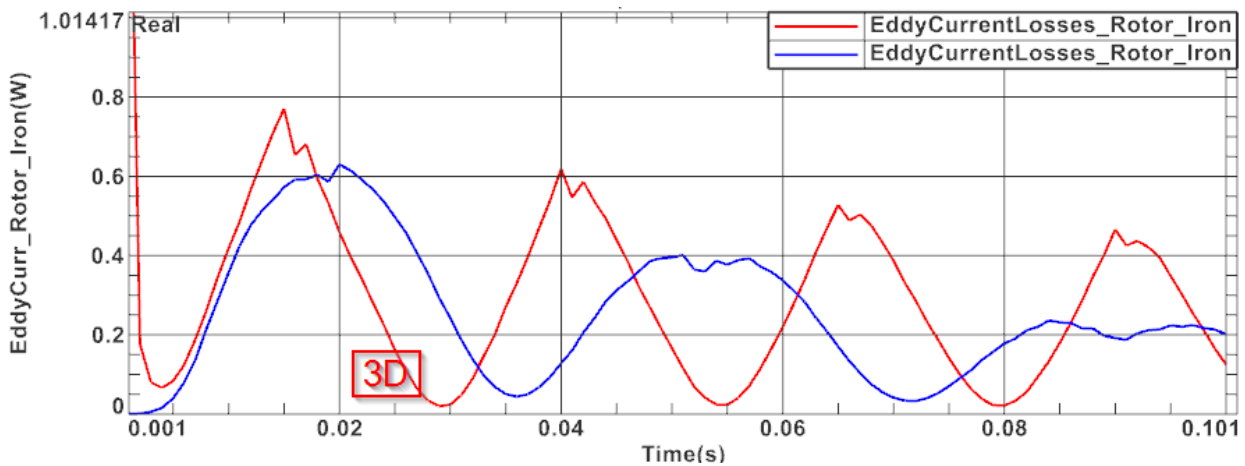

When comparing the 2D and 3D results one will find out that the simulated forces and torques are higher in the 3D case, even if the 2D is set to the same z thickness. Therefore, also the dynamic rotation speed becomes higher in 3D. This effect can be explained as follows: The magnetic forces appear mainly on the border faces between air and magnetic material. Because the 3D model has additional side faces, and these are used in the simulation, the forces here are

higher. The following picture illustrates this: It shows the force distribution on the 3D rotor. It can be seen, that forces are not homogeneously distributed. At the side faces they are higher. Also the magnetic flux density result shows this effect. This is one reason why 3D simulations can be more realistic.

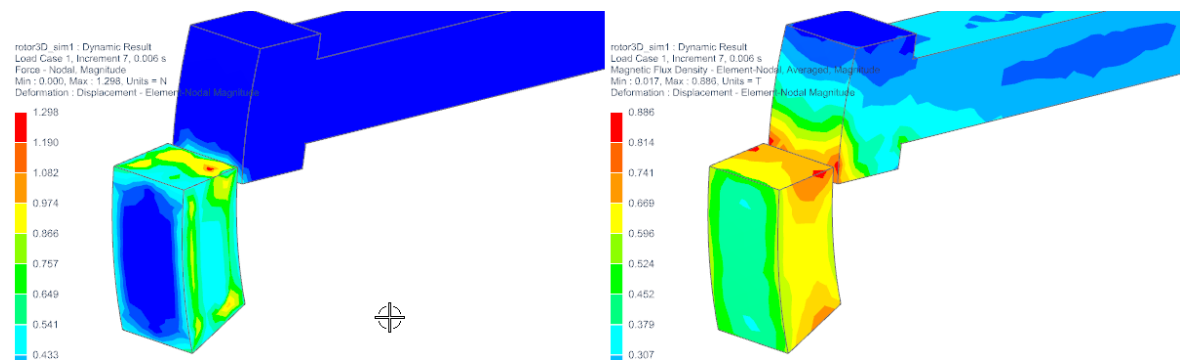

The tutorial is complete.

3 Tutorial 2

3.1 Relay 3D, Translational Motion

In this example we show the usage of the 'Dynamic General Motion' technique in the context of a 3D Relay.

Estimated time: 1 h

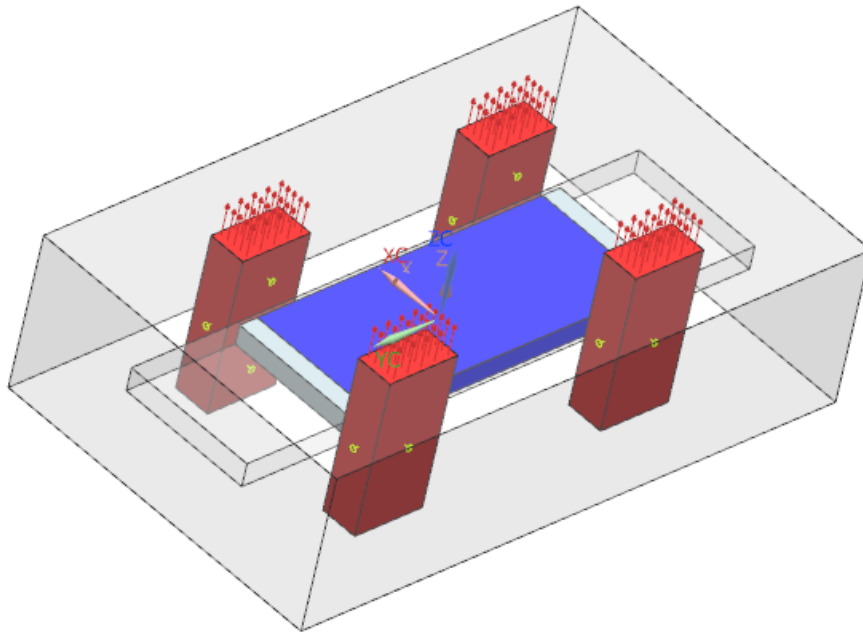

Follow the steps:

This example is shown using 3D, but the technique is possible in 2D very similar. The corresponding model in 2D is stored at the same folder location, so it can be seen there how it is set up.

Estimated time: 1 h

Follow the steps to reproduce it:

1. Download the model files for this tutorial from the following link:
<https://www.magnetics.de/downloads/Tutorials/6.CouplMotion/6.3Relay.zip>
2. Open the part file 'relay3D.prt'.
3. Start Simcenter Pre/Post, create a new Fem and Sim File for 3D.
 - Switch off 'Create Idealized File',
 - Chose Solver 'MAGNETICS' and Analysis Type '3D Electromagnetics',
 - Choose Analysis Type 'Magnetodynamic Transient'.

- In register 'Output Requests', 'Table', activate 'Motion Data'. Others can be activated as desired.

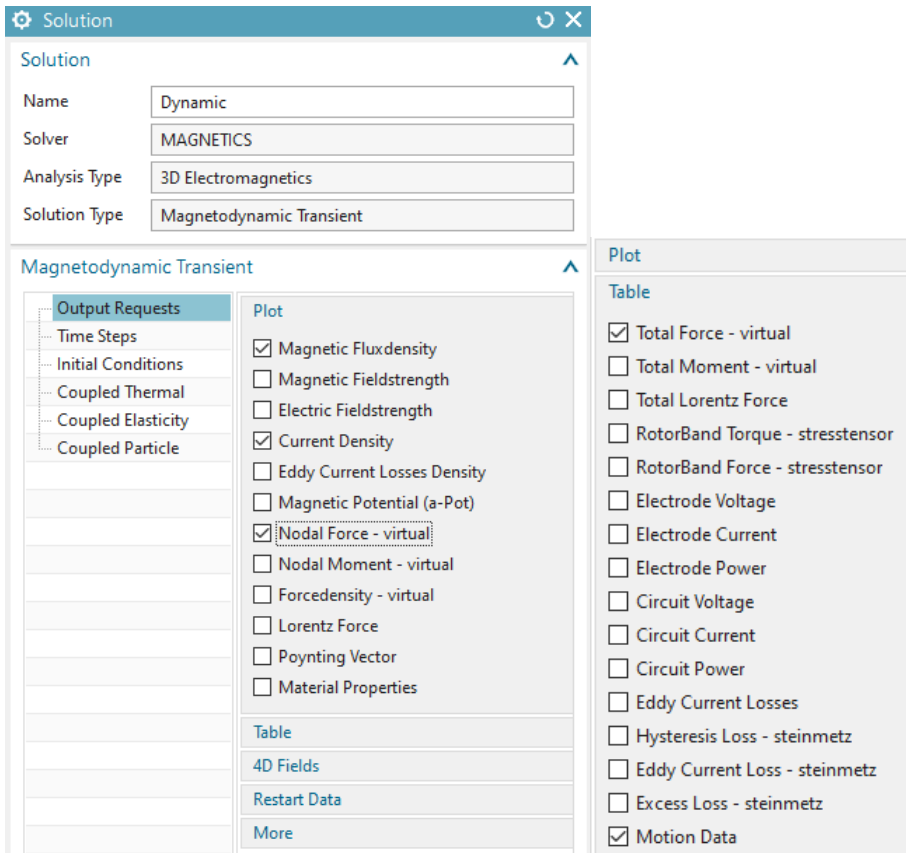

- In register 'Time Steps', select a time increment of 0.1 sec and 10 time steps.

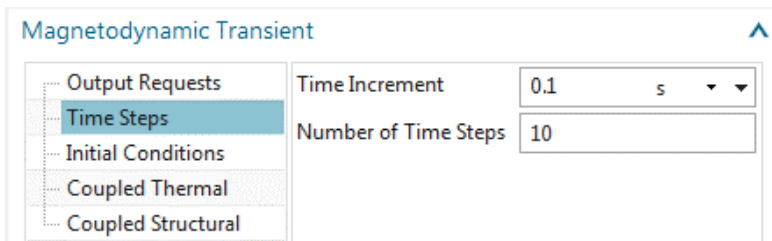

4. Change to the Fem file.

5. In the following steps we create all 3D Meshes (all but the air gap). This will be done by tetrahedral elements and appropriate mesh collectors.

- First, create mesh mating conditions. So, make all polygon bodies visible, click on 'Mesh mating Condition' , drag a window over the geometry, set the 'Mesh Mating Type' to 'Glue-Coincident' (default), click 'OK'. Check, there will be 22 mesh matings created.
- Then, mesh the Plunger with one fourth of the suggested mesh size. Assign the material 'Iron_Sample2' as well as a 'Rigid Body Motion' mass of 0.28 Kg.

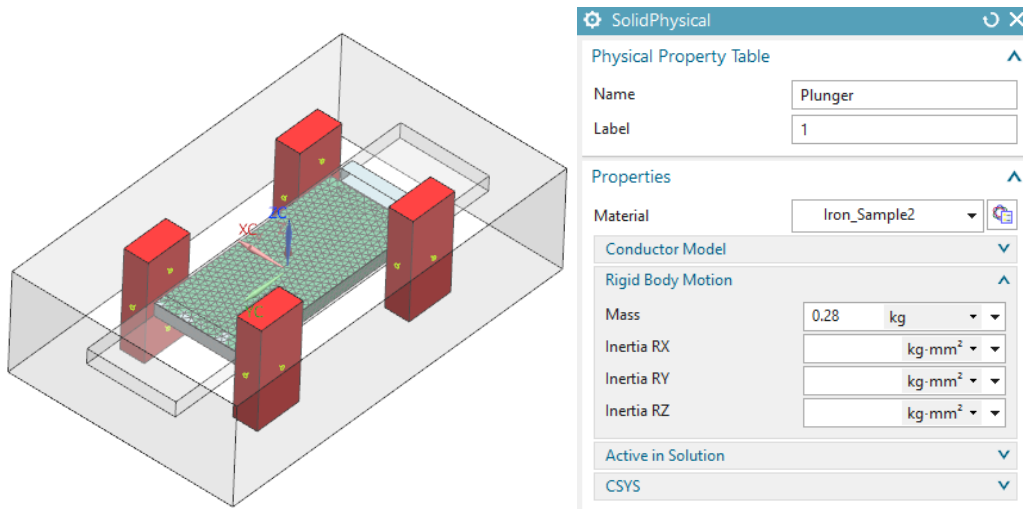

- Mesh the (two) moving air stripes with one fourth of the suggested element size. Use a 'FluidPhysical' and assign material 'Air'.

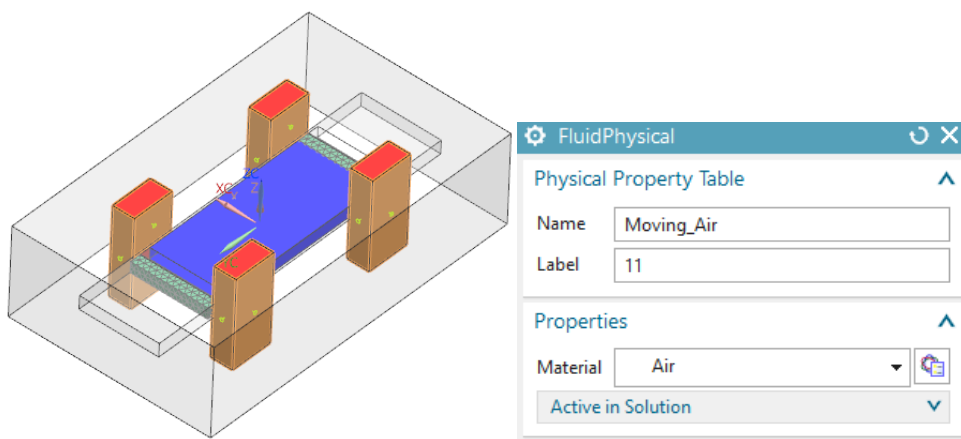

- Mesh the first Coil with the suggested mesh size and assign material 'Copper'. Also, set the 'Conductor Model' to 'Stranded' with 50 turns, a fill factor of 1 and a coil section area of 741 mm².

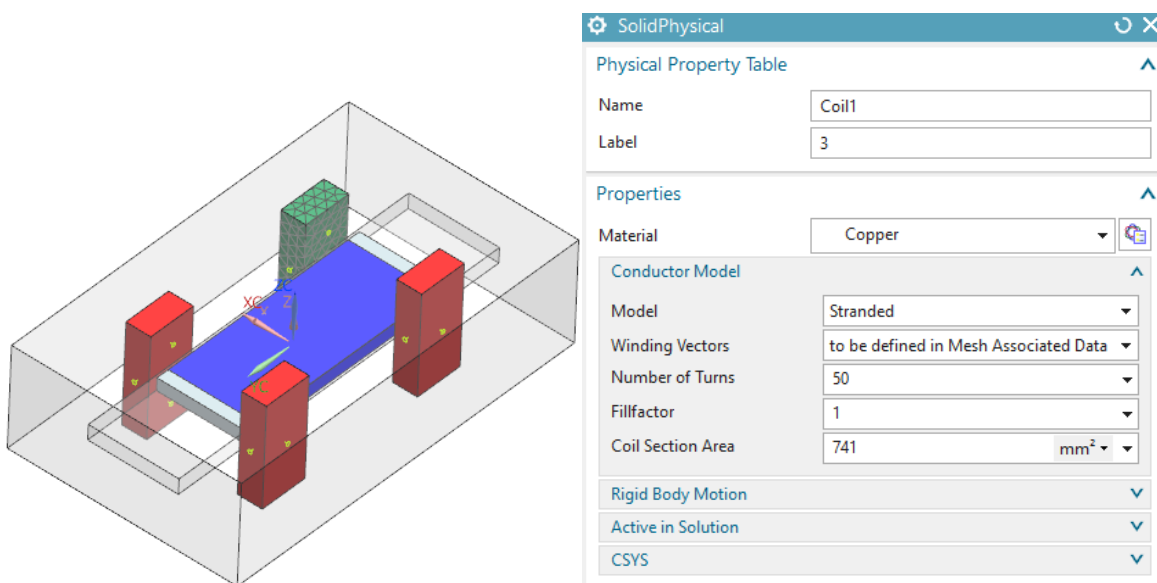

- Edit the 'Mesh Associated Data' of the coil mesh and define the direction of current (use one of the z-dir edges. Take care that the polygon body is shown.).

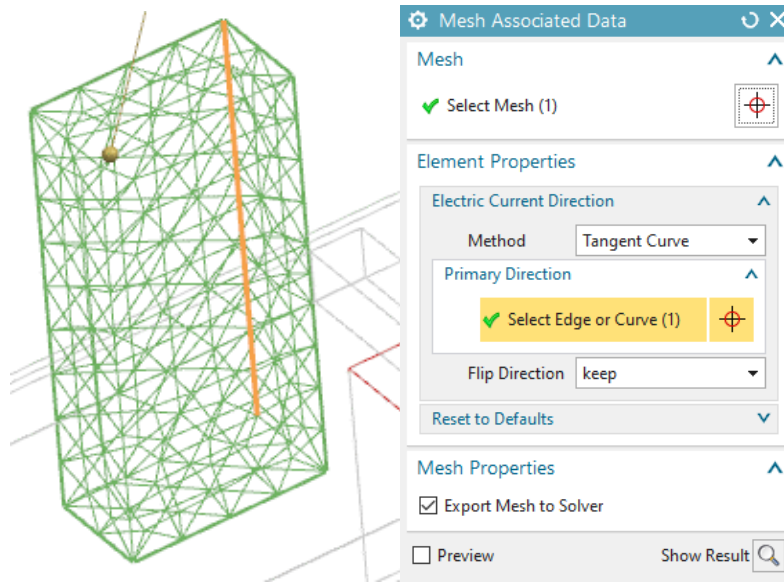

- Proceed in the same fashion with the other three coils (meshing, material and current direction).

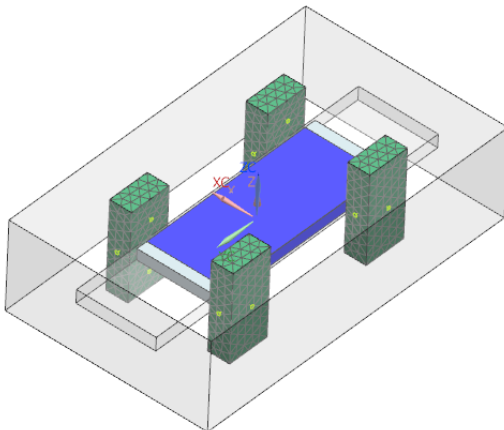

- Finally, create a mesh with one third of the suggested mesh size for the stator air and set the small feature tolerance to 2%. Again, use the type 'FluidPhysical' for this.

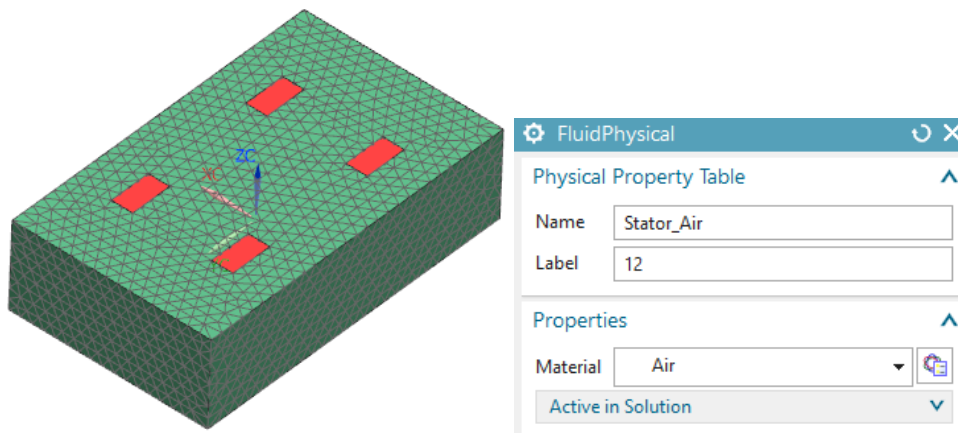

- Following we do preparations for the 3D air gap mesh. E.g. the mesh that will update with each movement step. Following picture shows the plunger and how the updating air gap surrounds it. So, if the plunger moves and the air gap is updated, a new simulation step can be done.

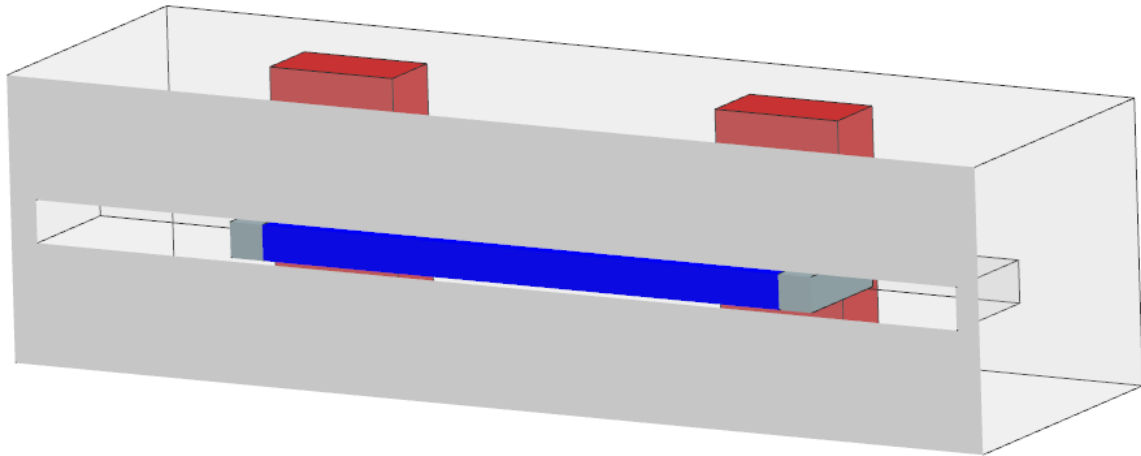

This updating air gap mesh will be of type 'Solid from Shell Mesh' and therefore needs 2D boundary meshes from which it depends. Therefore, NX Magnetics provides a feature that allows to recreate that mesh prior to each solve. We will set up this feature now.

- Following you create all boundary meshes of the updating air gap. Therefore, you create surface coat meshes (picture below left) on all faces that belong to the boundary of the air gap. The right side picture below shows how the navigator looks after all the boundary meshes are there.

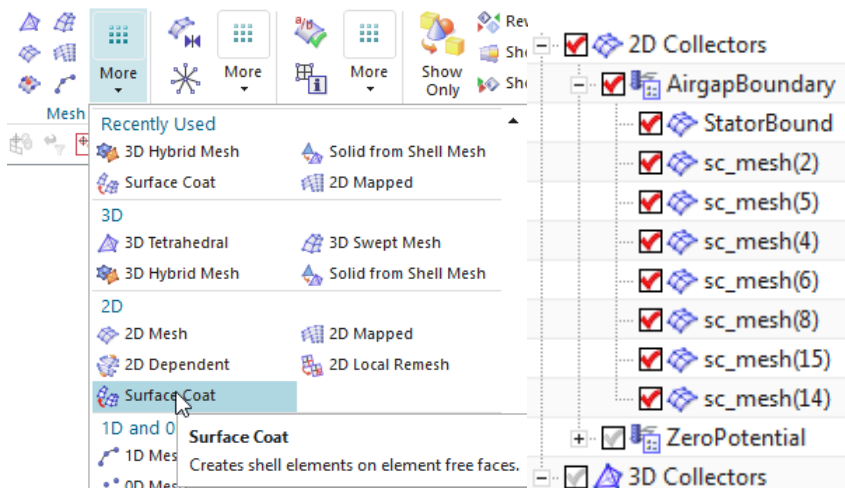

- To collect the following meshes, first create an 2D mesh collector, name it 'Airgap-Boundary'. Use a physical of type 'NotToSolver' because these meshes will act as borders only for the 3D air gap mesh.

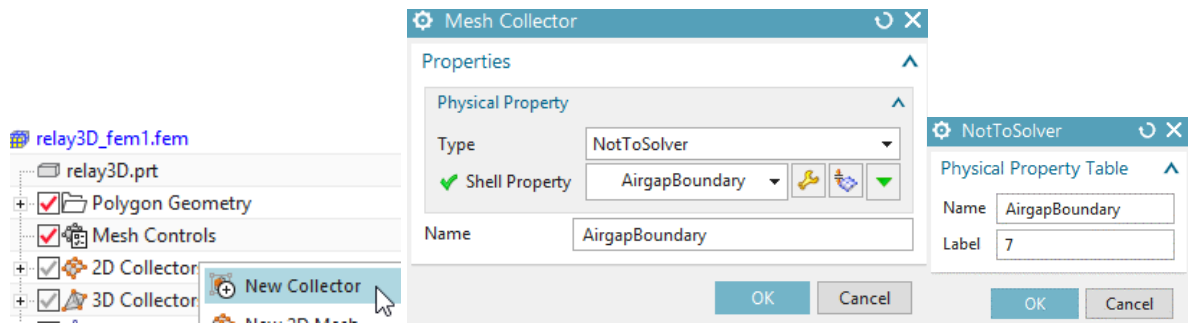

- First, create a 'surface coat' on the 4 inner side sections of the four coils that are in contact with the moving air (see below).

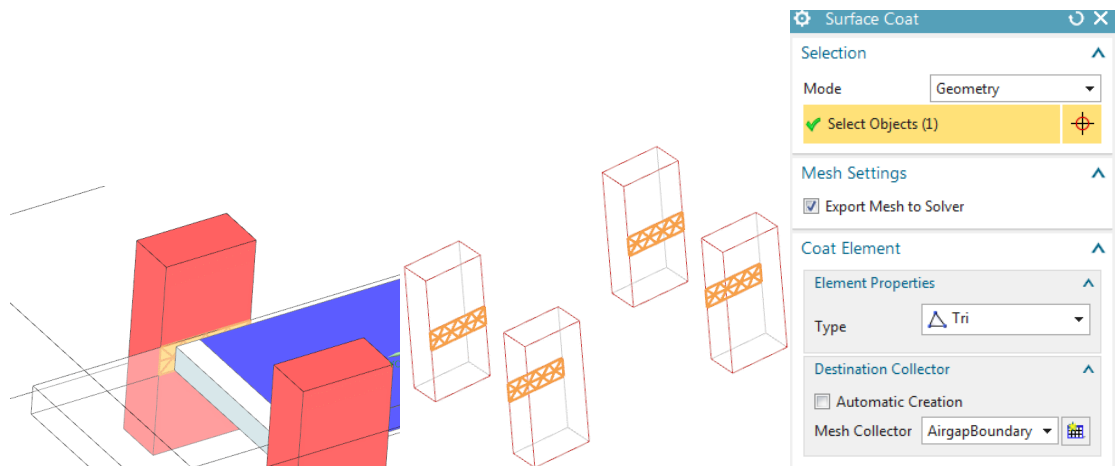

- Next create surface coat meshes for the left (e.g. green mesh) and the right surface parts of the moving air.

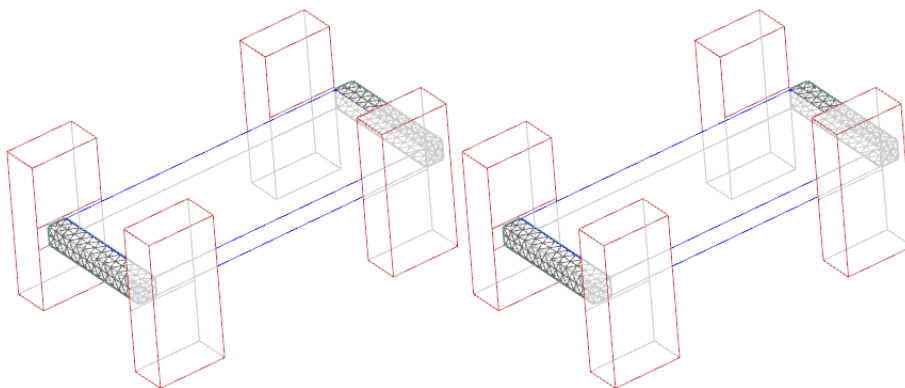

- Then, create a surface coat mesh for the moving air.

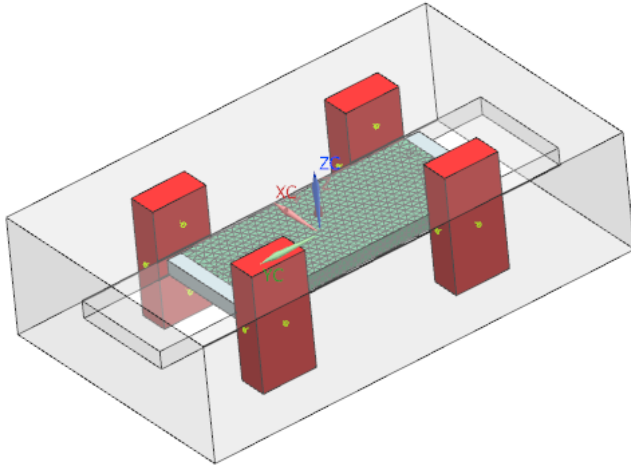

- Finally, create a surface coat mesh stator bound air (that provides the extend over which the air can move). For easier selection of these interior faces of the 'Stator_Air', use the helpful 'Clip Section' feature from toolbar 'View'. Select all inside faces of the air as shown in the picture below (Note: You have to invert the clip section to select the faces on the opposite side).

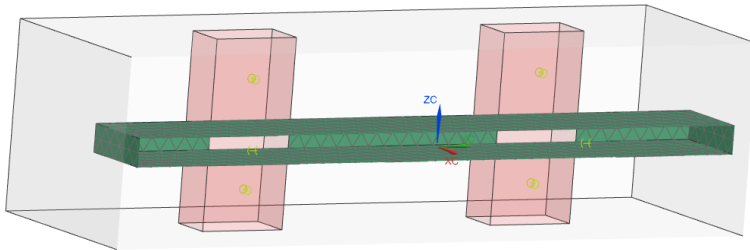

- When all boundaries are visible, it should look like the following picture.

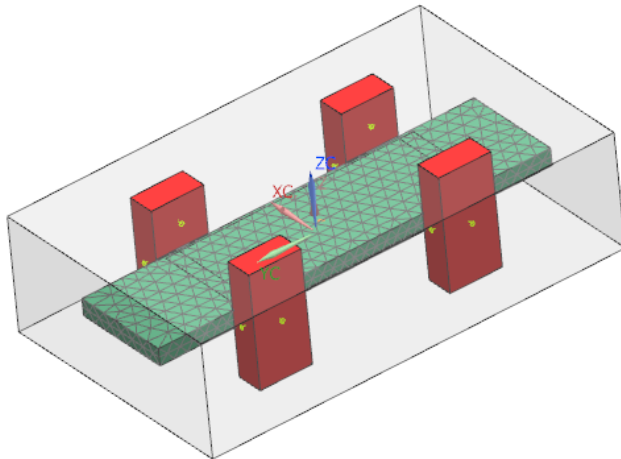

7. With these air gap boundaries being completed we now set up the automatically updating 3D air gap mesh:

- Create a 3D mesh collector.

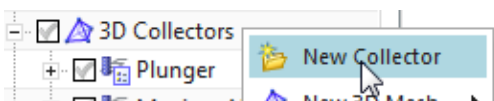

- Name the collector UpdateAirGap, set the physical type to FluidPhysical, click Create Physical and set the material to Air. Click Ok.

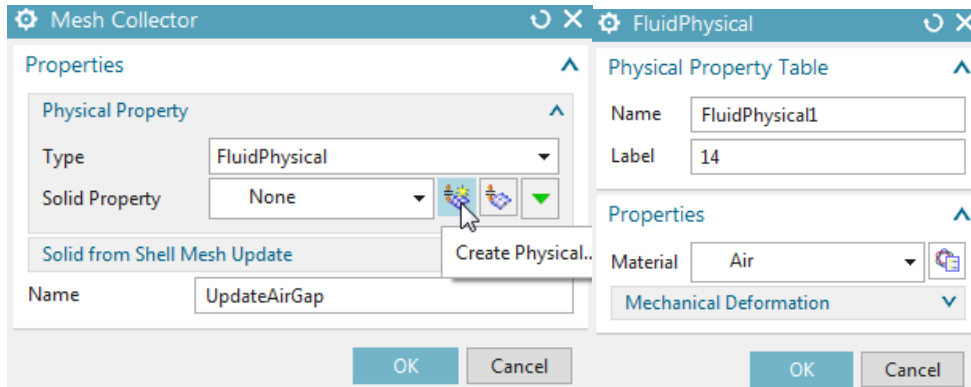

- Back in the mesh collector dialogue expand the box 'Solid from Shell Mesh Update' and set the option Activate to 'Create/Update Mesh at Solve'.

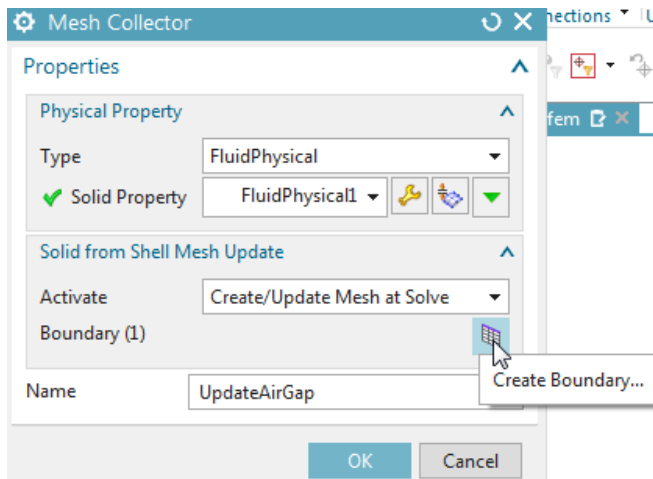

- Click on 'Create Boundary' and in the following dialogue select the previously created physical AirgapBoundary that holds the 2D boundary.

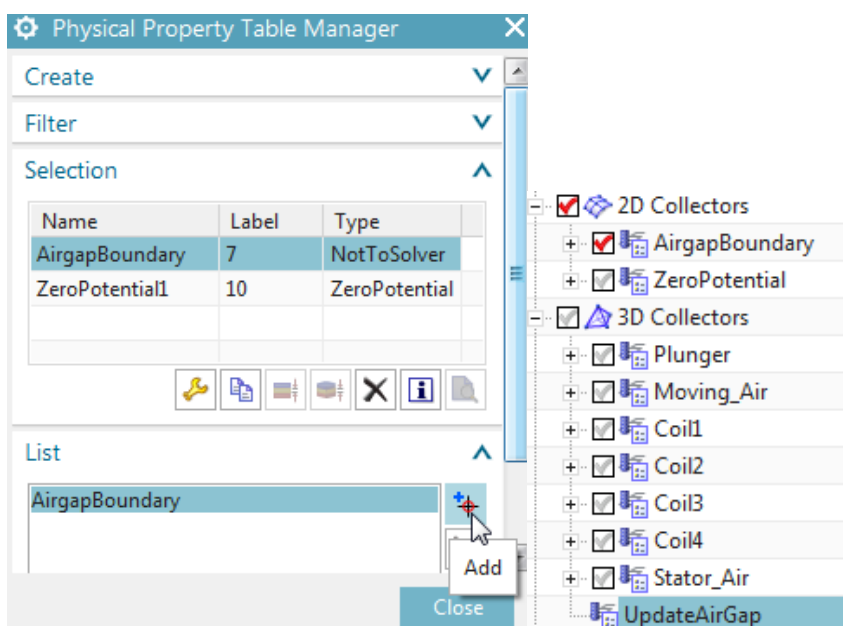

- Click Close, Ok and the mesh collector is created. Notice that it contains all necessary information to create a Solid from Shell Mesh, but the mesh itself will be created at solve time. (Alternatively you can create the mesh manually now, it makes no difference).

8. Now create all outer 2D surface coat meshes (equivalent as in the last step). However, in contrast to the last step, use a physical property of type ZeroPotential. Hint: We do this procedure in order to fix the Boundary condition (i.e. ZeroPotential) directly in the .fem file. However, this could also be done in a later step in the .sim file.

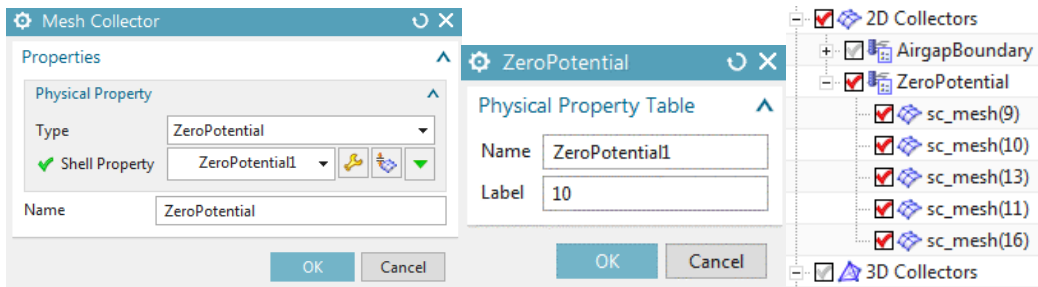

- First, create surface coat meshes for the top and bottom sides of all four coils (see picture).

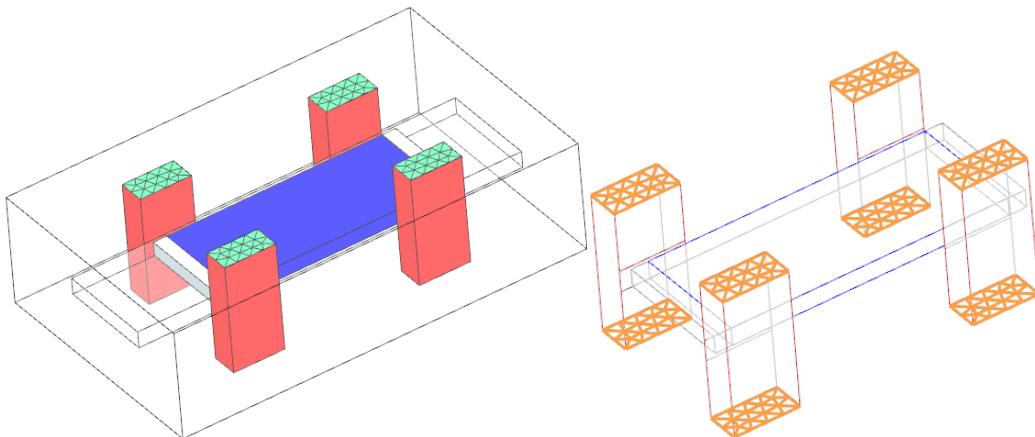

- Then create a surface coat mesh for the outer air.

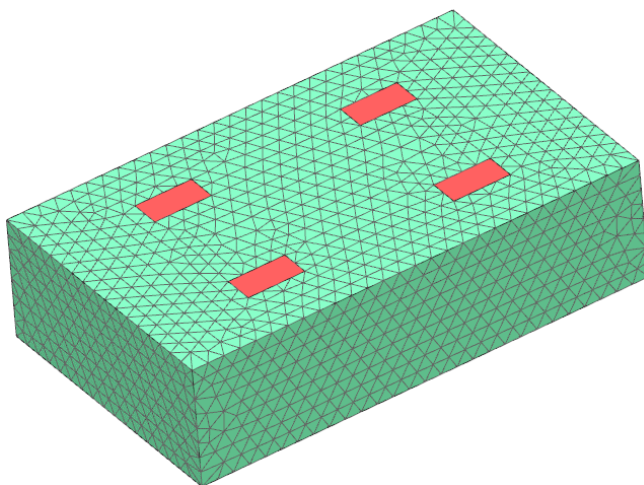

9. Meshing is done, change to the Sim file.

10. Create a Dynamic Motion to define the movement of the plunger.

- Create a simulation object of type 'Dynamic Motion'. Activate 'Slider by General Motion'.

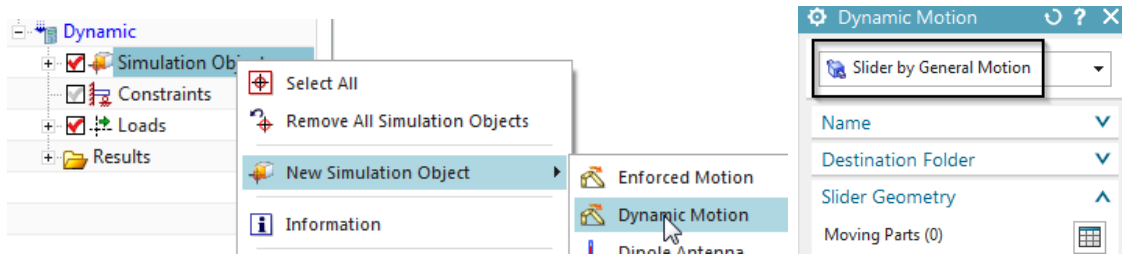

- In the dialogue first define the Slider Geometry. Click on 'Create Moving Parts' and add the two physicals Moving_Air and Plunger that will move to the list. Click Close.

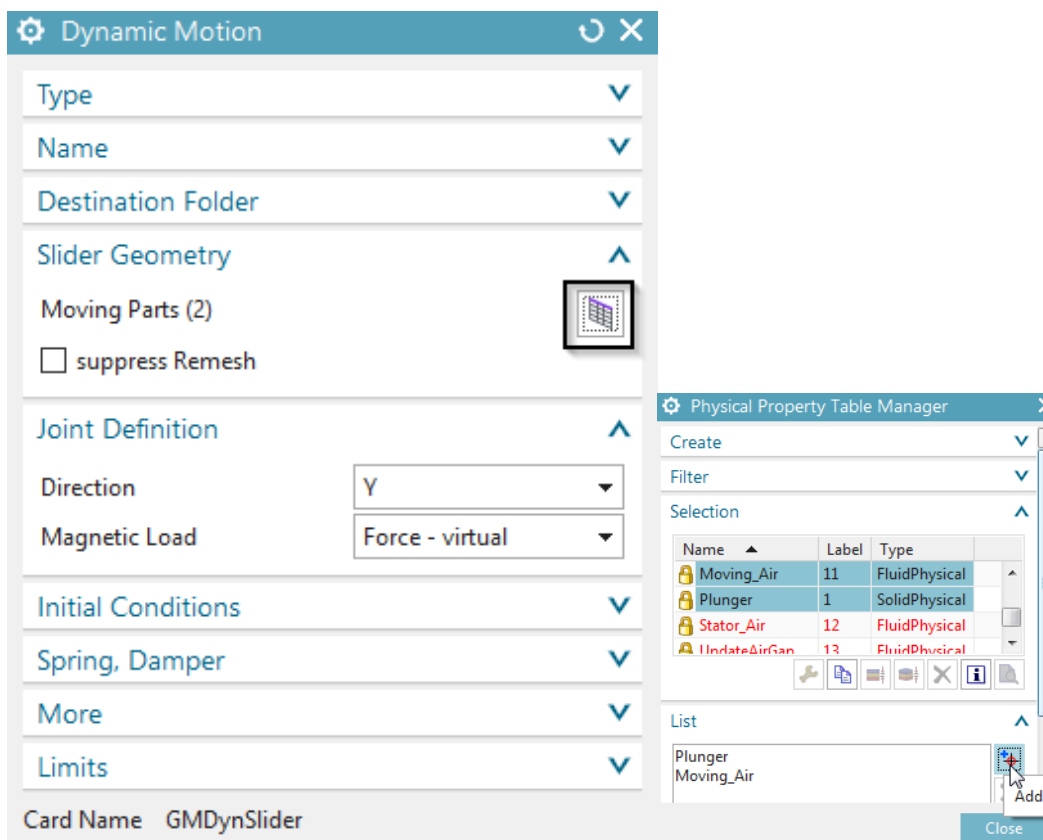

- Back in the Dynamic Motion dialogue, set the Direction to Y and accept all other defaults with Ok.

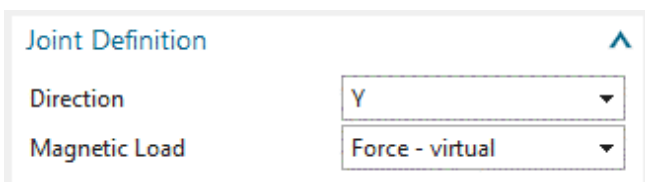

11. Define the electric currents on the four coils: Define zero amperes on the two right coils (see picture) and define 10 and -10 amperes on the two left coils. This will result in a Y force on the plunger.

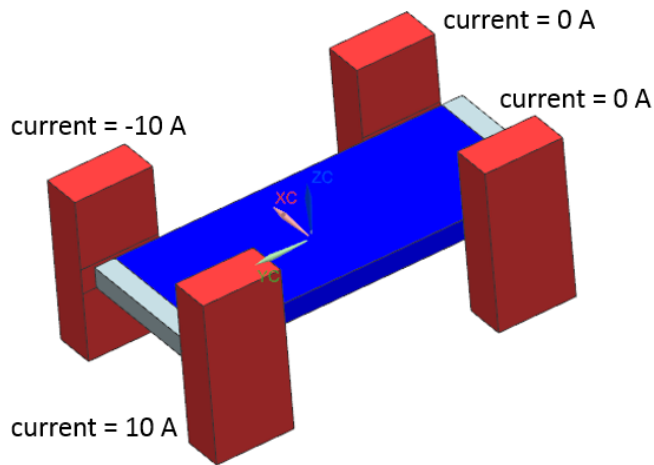

12. Solve the solution.

13. Post processing.

- We first check the motion data result. This contains Total Displacement, Displacement Step and Velocity.
- Open the associated result file in the post processing navigator. A list of all tabular results appears above the plot results.
- plot the three results as shown below.

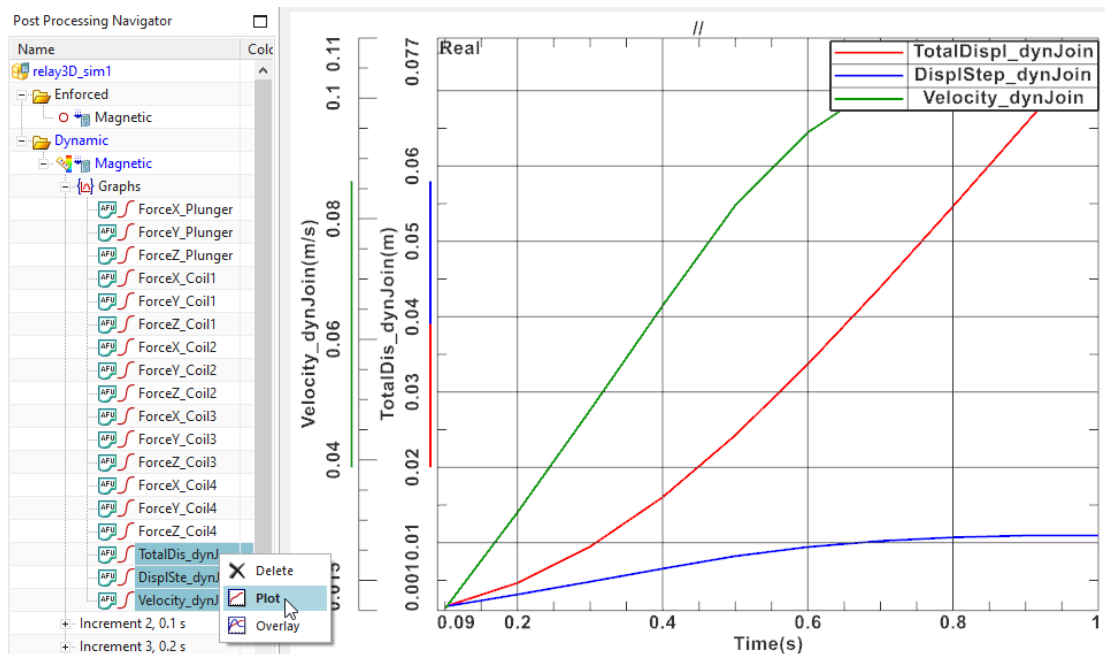

- If acceleration is needed this can be derived by differentiation using the mathematical operations for afu graphs.

14. Next we check the plot results. After 10 time steps the Magnetic Flux density field on the slider should look as follows

Name	Colc
relay3D_sim1	
+ Enforced	
- Dynamic	
+ Magnetic	
+ Graphs	
+ Increment 2, 0.1 s	
+ Increment 3, 0.2 s	
+ Increment 4, 0.3 s	
+ Increment 5, 0.4 s	
+ Increment 6, 0.5 s	
+ Increment 7, 0.6 s	
+ Increment 8, 0.7 s	
+ Increment 9, 0.8 s	
- Increment 10, 0.9 s	
+ Displacement - El...	
+ Magnetic Flux De...	
+ Increment 11, 1 s	
+ Increment 12, 1.1 s	
+ Imported Results	

relay3D_sim1 : Dynamic Result
 Load Case 1, Increment 10, 0.9 s
 Magnetic Flux Density - Element-Nodal, Unaveraged, Magnitude
 Min : 0.0000, Max : 0.0477, Units = T
 Deformation : Displacement - Element-Nodal Magnitude

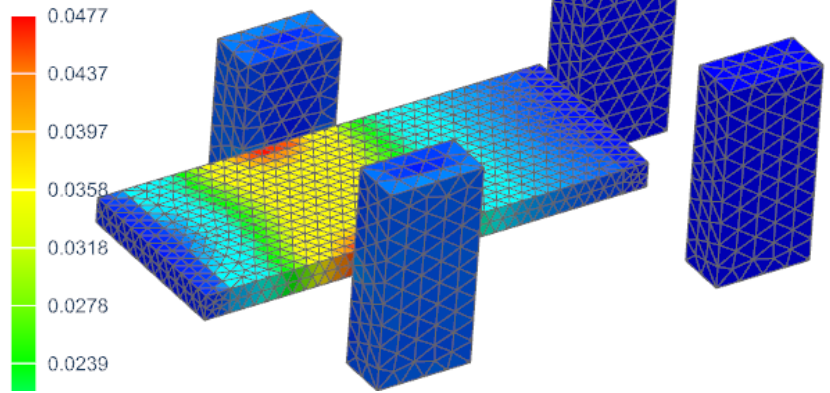

This ends the tutorial.

4 Tutorial 3

4.1 Permanentmagnet Synchron Motor Analysis

In this tutorial a permanent magnet electric motor is analyzed for torque. Notice that there is also a video of this tutorial in <https://magnetics.de/index.php/learn>.

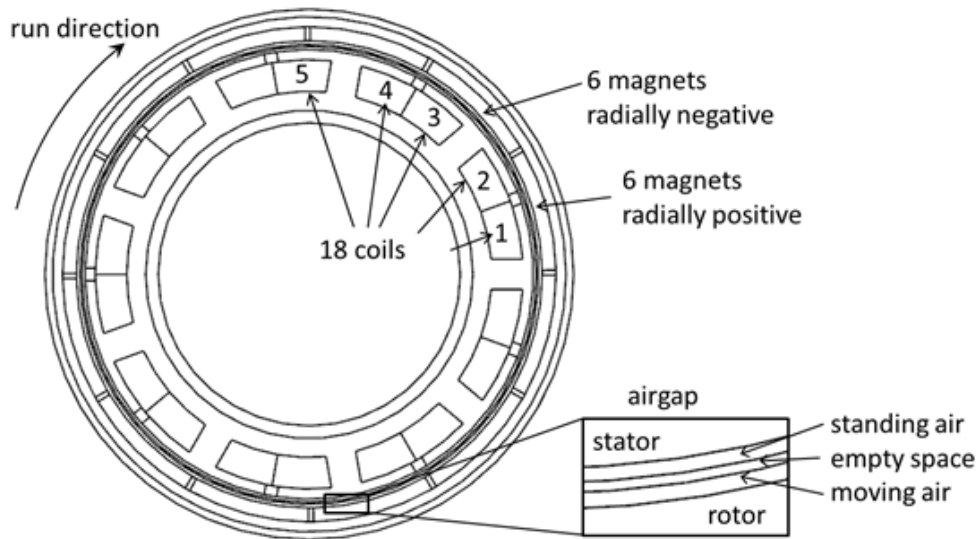

4.1.1 Model Setup by AutoFEM

For this model setup we want to use the feature 'AutoFEM' that allows to perform this process highly automatized. Some preparations in the CAD (already done here) are the following. The faces of the CAD model have names. When building the fem model with 'AutoFEM' we will take advantage of these preparations. To assign names to a CAD face you can select a face and then go to RMB properties. Follow the steps:

1. Download the model files for this tutorial from the following link:
<https://www.magnetics.de/downloads/Tutorials/6.CouplMotion/6.4ElectricMotor.zip>
2. Open part 'ElectricMotor.prt'.
3. Start Simcenter and the Pre/Post application and chose function 'New FEM and Simulation'.
4. Switch off 'Create Idealized Part', set the Solver to 'MAGNETICS' and 'Analysis Type' to '2D or axisym Electromagnetics'.
5. Choose the solution type 'Magnetodynamic Transient'.
6. In the dialog Solution set the settings in registers 'Output Requests' and '2D' as shown in the next picture. OK.

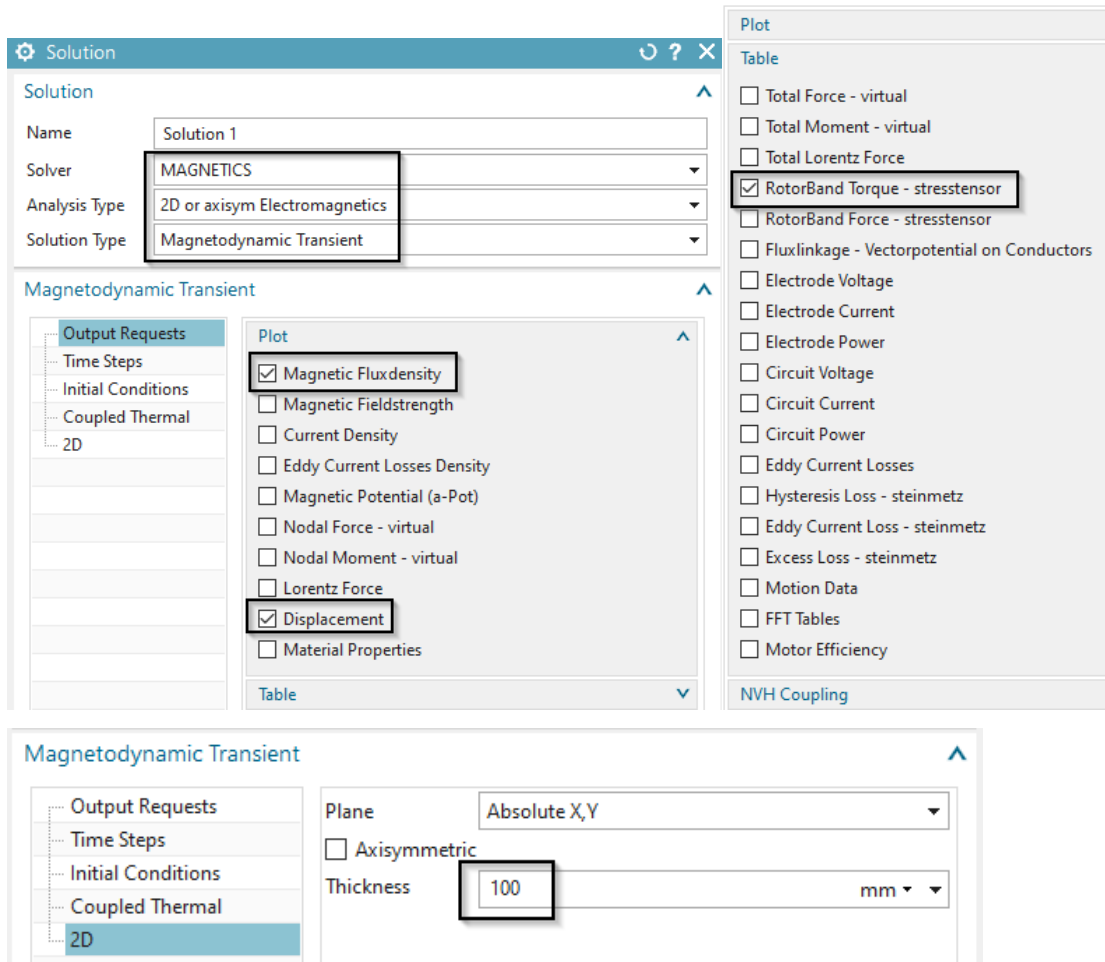

7. Change the displayed part to the Fem file.

8. As a prerequisite step add the required Materials to the local libraries; to do so follow the workflow below.

Hint: This prerequisite step must be done for an AutoFEM simulation with automatic Material assignments; more precisely said materials must be added to the 'local materials library' first, in order to be properly assigned later by the AutoFEM function. Note that this must be done before the usage of the AutoFEM function.

- First, Select the 'Manage Materials' button

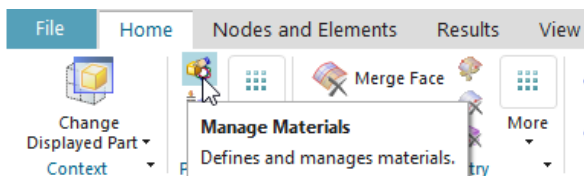

- Then, right click on the material 'ElectroSheet_Sample2' from the Magnetics Library and select 'Load Library Material', to load this Material into the local material Library.

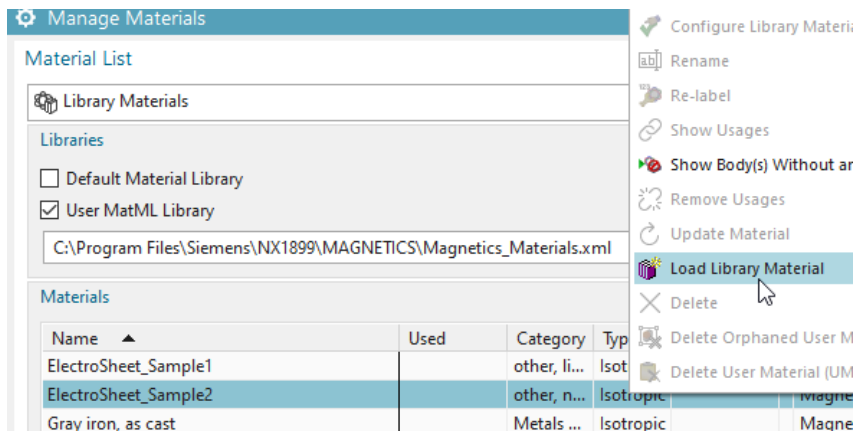

- Repeat the last step for the other four required materials (see picture below). After completion the Local Materials List looks as shown below.

Name	Type	Label	Library	Magnetic relative Permeabilit...	Magnetic Remanent Fieldstrengt...	Electric Conductivity..
Air	Fluid	1	Magnetics_Materials.xml	1	0 A/m	0
Copper simple	Isotropic	2	Magnetics_Materials.xml	1	0 A/m	58000000
ElectroSheet_Sample2	Isotropic	3	Magnetics_Materials.xml	1500	0 A/m	58000000
N30EH at 100C	Isotropic	4	Magnetics_Materials.xml	1.07653	761621 A/m	625000
N30EH at 100C (neg)	Isotropic	5	Magnetics_Materials.xml	1.07653	-761621 A/m	625000

- For easier display of colors: RMB on the Fem file, choose 'Edit Model Display...', register 'Element' and set the 'Color Basis' to 'Material Property Table'. This will later make the meshes look in different colors as shown in the below picture right side.

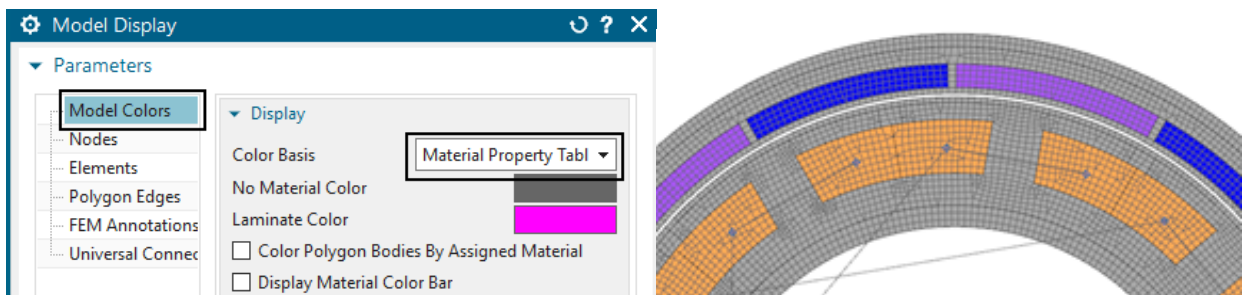

- Choose the function 'Auto FEM'  from the Magnetics toolbar and choose the register '2D'. Activate the settings as shown in the picture.

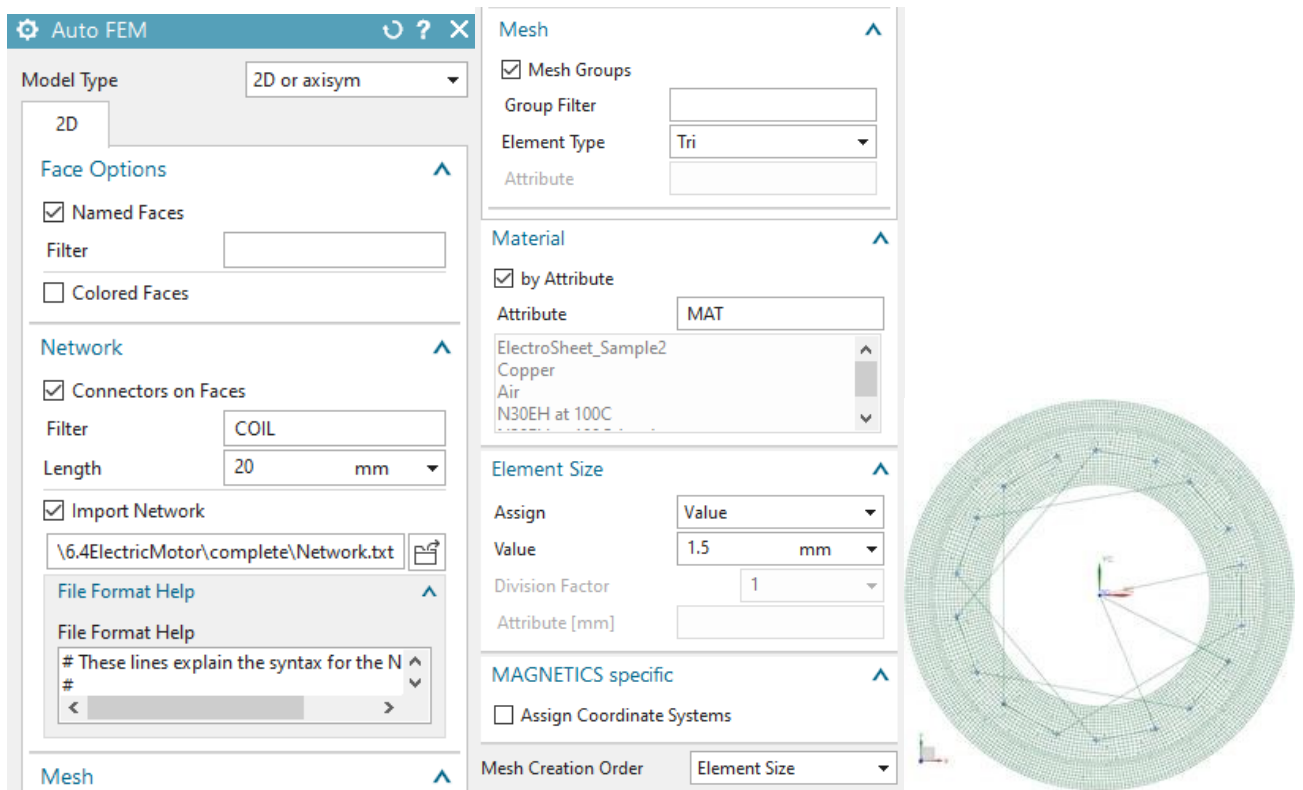

Hints:

- 'Named Faces': All faces that have names in the CAD part will be found and there will be groups created for them in the Fem part.
 - 'Connectors on faces / Filter': All faces that have a name starting with 'COIL' will be found. A connector element will be created on those faces. Connector elements are necessary to connect 1D circuit networks to the finite-element mesh. The length of those connector elements will be 20 mm. This setting only plays a role for visibility effects. Each connector element will have two points (A and B) which can be understood as the coil ends.
 - 'Import Network': The file 'Network.txt' that is chosen contains definitions for 1D circuit network elements. Those elements contain the winding scheme in our case. Take a look into this text-file to see the definitions.
 - 'Mesh Groups': This option leads to a meshing of all groups that correspond to the value in the 'Group Filter'. If the 'Group Filter' is empty as in our case simply all groups will be meshed.
 - 'Element Type': The meshing will be done using the given element type.
 - 'Material': The option 'By Attribute' will search for the given attribute ('MAT' in this case) on faces of the geometry to select a material.
 - 'Element Size': The size for the elements. Hint: You can use expressions here. This makes it easy to change the mesh sizes later.
11. Press OK in the Auto FEM dialog. The network and meshes are created.
 12. Edit the physical properties of the coils:

- First, edit the physical of the first coil (i.e. COIL01). Apply the settings for 'Material' and 'Conductor Model' as shown below.

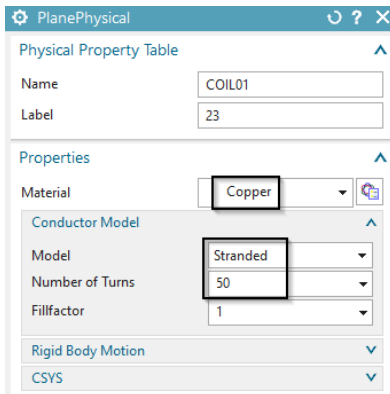

- To copy the properties of this first coil to all other coils you select the button 'Multi Physical Edit'  from the Magnetics toolbar. Insert the name of the physical to copy from 'COIL01' and 'COIL' as a filter for the physicals to copy to, OK.

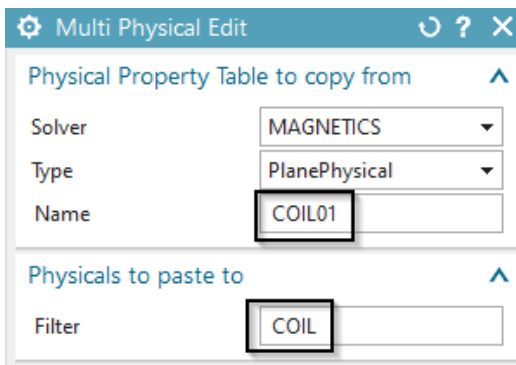

- Maybe you check some other coils to verify they now all have the same properties.

13. Edit the magnets:

- Modify the physicals of the magnets 'MAGNET_NEG1' and 'MAGNET_POS1'. Set the 'Material CSYS' to 'Cylindrical' and choose for the 'Material Orientation' the absolute  coordinate system. See the settings as shown in the next picture.

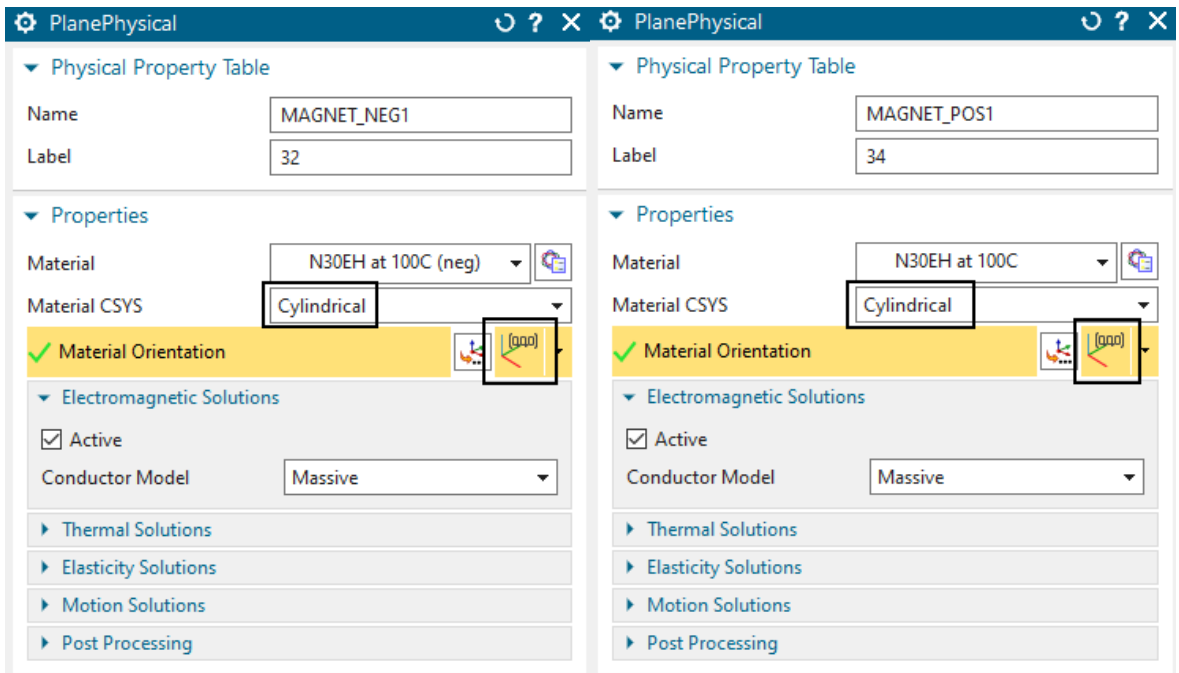

- Again use the 'Multi Physical Edit' to copy these properties to all other 'MAGNET_NEG' and 'MAGNET_POS' magnets, respectively.

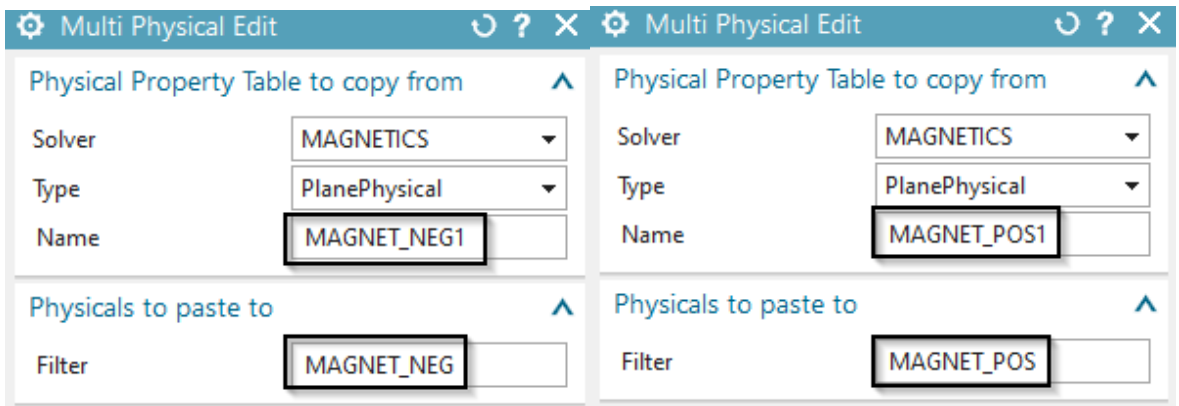

14. Edit the Iron: The Rotor and Stator should be set to 'Conductor Model' 'Laminated'. Otherwise the default model 'Massive' would be active and this would result in strong eddy current effects (if the solution is dynamic). So, modify the two physicals as shown in the following picture.

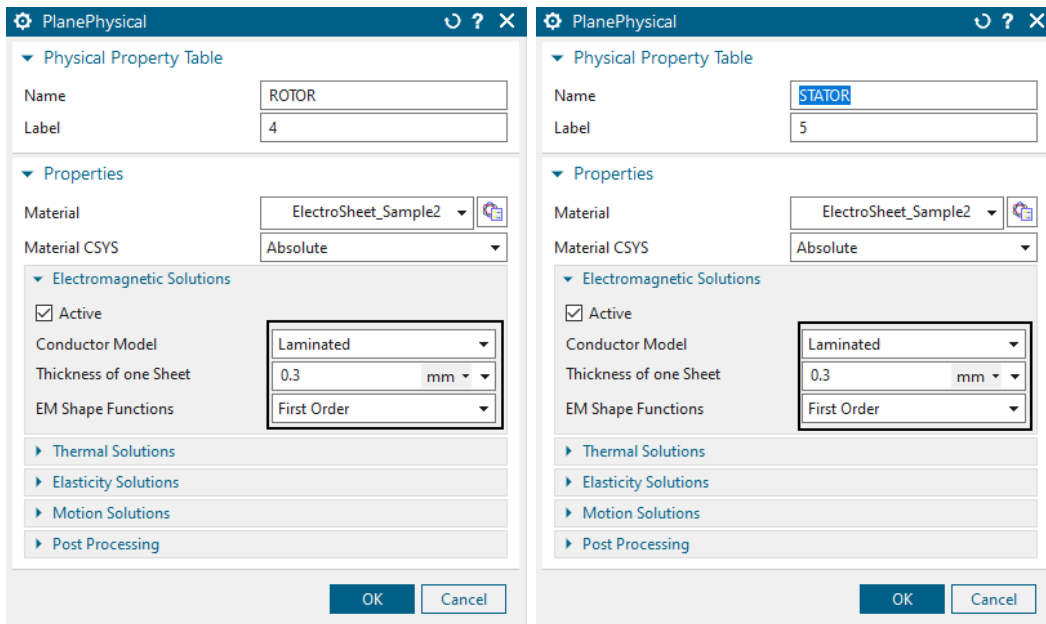

15. Edit the resistors in the 1D network: Edit the mesh 1D collector 'ResistorsFromFile'. Create a new physical there and insert a resistance value of 2 ohm. Hint: This value only influences results if the motor is driven by voltage.

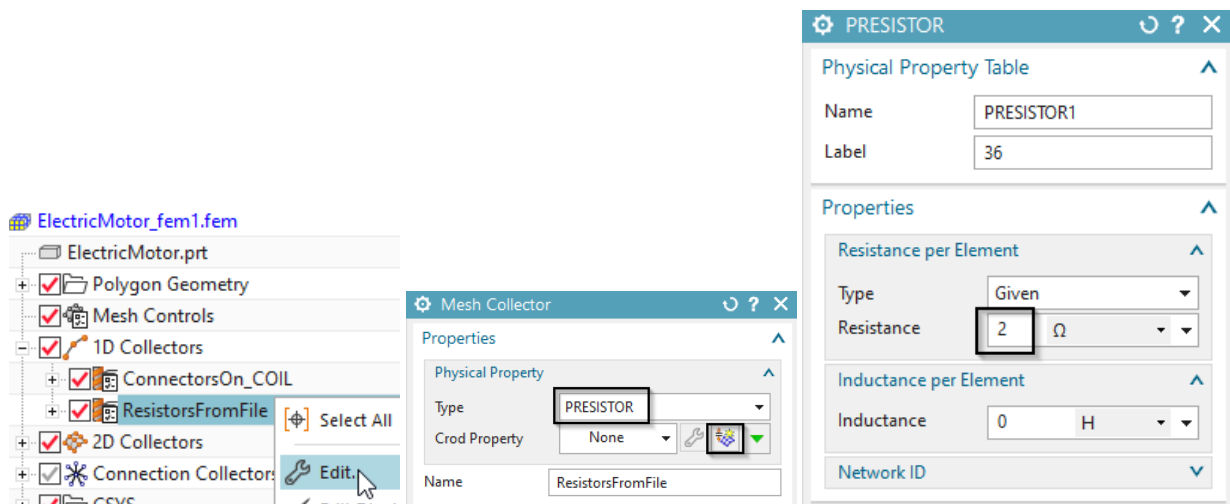

16. Switch to the Sim file.
17. Create parametric expressions: Create the following expressions. To create them, either use the dialogue (Menu, Tools, Expressions). Alternatively run the journal 'CreateExpressions.vb' in the part directory to automatically create them. (Menu, Tools, Journal, Play, Browse and select the vb file, Run)

↑	Name	Formula	Value	Units	Dimensionality	Type
1	Default Group					
2				mm	Length	Number
3	CurrentAmplitude	6	6 A	A	Electric Current	Number
4	CurrentFrequency	$(6 * \text{SpeedMech} / 360) * (180.0 / \pi)$	0.1 Hz	Hz	Frequency	Number
5	Poles	6	6		Unitless	Number
6	RotorStep	-1	-1 °	°	Angle	Number
7	SpeedMech	1	1 rev/min	rev/min	Angular Velocity	Number
8	TimeIncrement	$-1 * \text{RotorStep} / \text{SpeedMech}$	0.1666666667 s	s	Time	Number

18. Edit the solution and set the

- 'Number of Time Steps' to 90
- 'Time Increment' to the newly created expression 'TimeIncrement'.

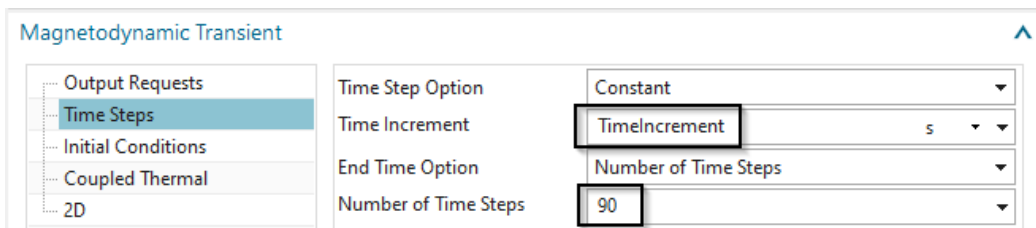

19. Define the rotor motion:

- Create a simulation object of type 'Enforced Motion 2D'. Accept the default type 'Revolute by Moving Band'.
- Select the 'Airgap Rotor Edge' (outer) and the 'Airgap Stator Edge' (inner).

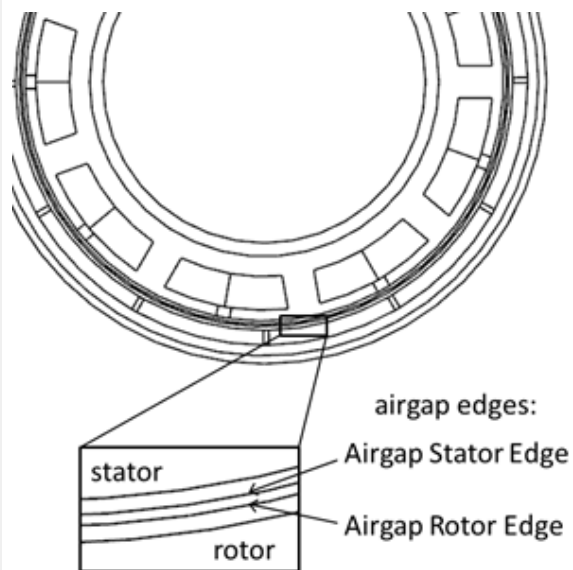
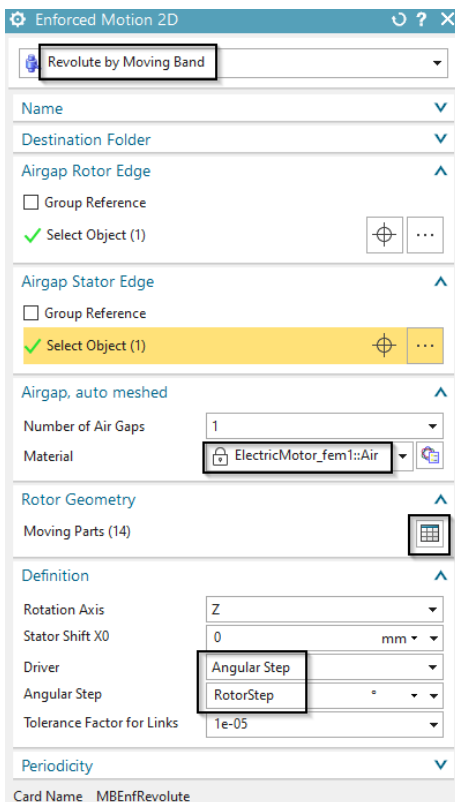

- Assign Air for the material at the air gap.
- Also, at 'Rotor Geometry' select the 'Moving Parts'.
These are ROTOR, ROTOR_AIR and all Magnets as shown in the below picture.

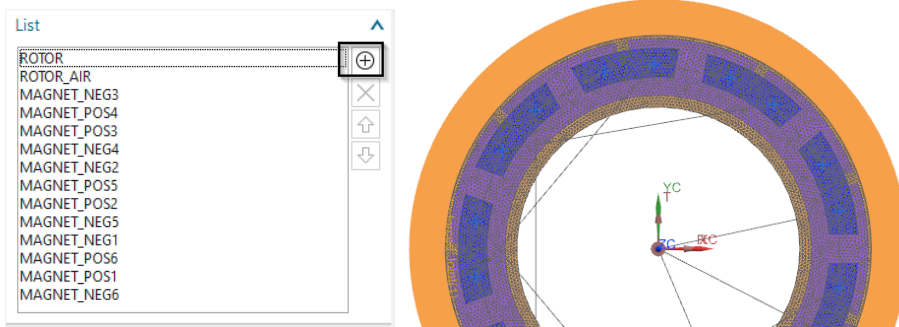

- Enter the expression 'RotorStep' in the field 'Angular Step'.
- Click OK to create the joint feature.

20. Define current for phase u:

- blank all 2D meshes.
- Create a Load 'Current 2D' with Type 'On 1D-Circuits' and set the Method to 'Harmonic'.
- For 'Primary Node', select the point that is marked in the picture as 'U phase'. (Hint: The node is on the z=0 plane)
- For 'Secondary Node' select the starpoint.
- For 'Electric Current Amplitude', key in the expression 'CurrentAmplitude'.
- For 'Frequency' key in 'CurrentFrequency'.
- The 'Phase Shift' stays zero for phase u.
- Assign name 'u'. OK.

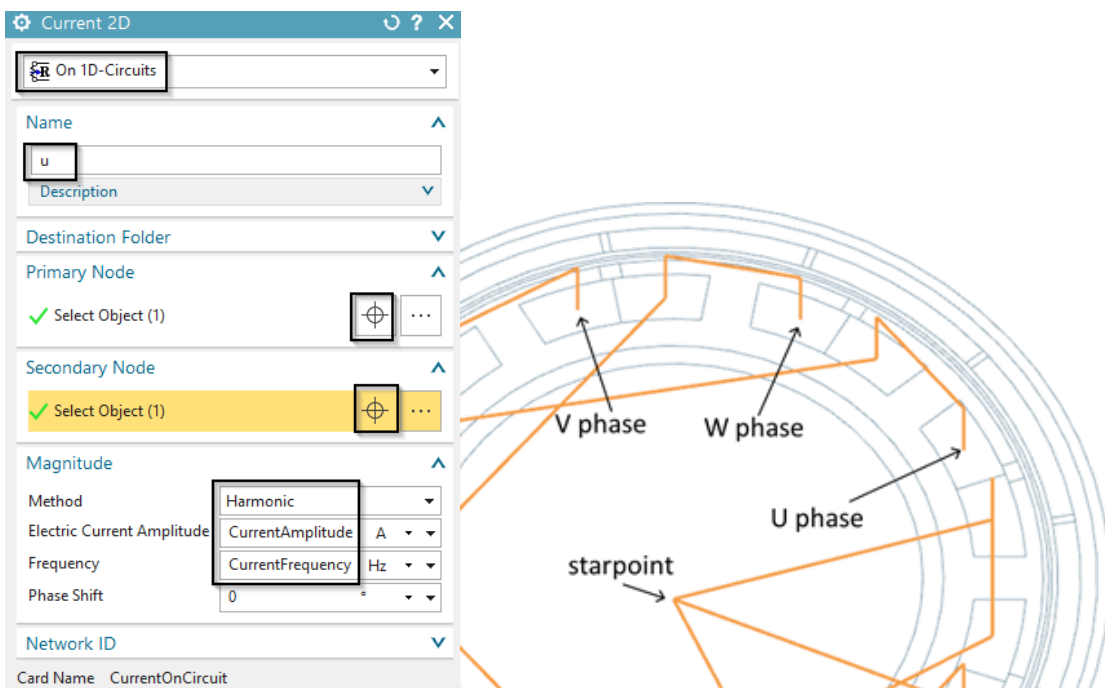

21. Define current for phase v and w:

- Repeat the last steps with exception of the 'Primary Node' selection and 'Phase Shift'. For phase v use 120 degrees and for phase w use 240 degrees.

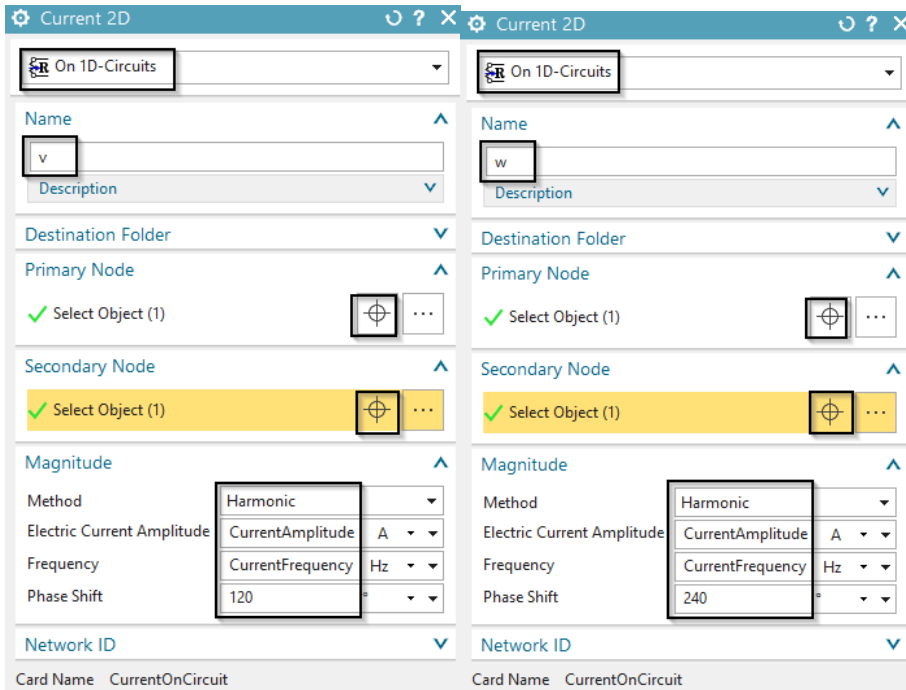

22. Define the environment condition:

- Create a constraint of type 'Zero Potential - Flux tangent' on the two circular edges (outside and inside) shown in the picture.

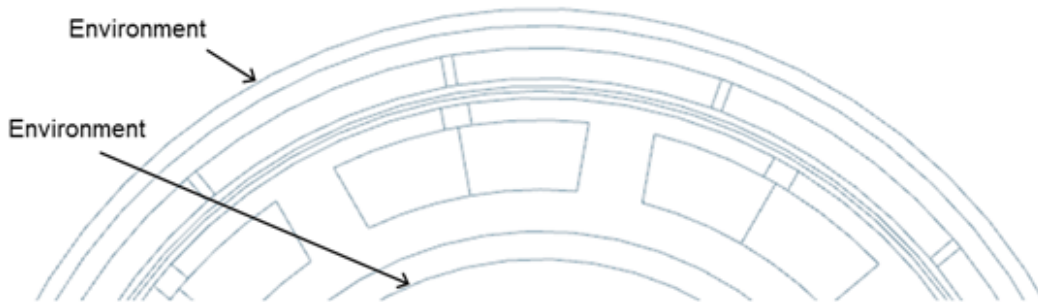

4.1.2 Find the Rotor Start Position for Maximum Torque

The model is now ready to solve, but in a first step we should find the correct rotor position. Normally for synchronous motors, this is the position of maximum torque. So, we have to find this and then set the rotor to that specific angle. One way how to find this is to run the motor without motion and check for torque. Because the rotor moves in negative direction we have to find the max negative value, e.g. the minimum.

1. Edit the enforced motion joint and set the 'Angular Step' (temporary) to 0. We want to fix the rotor and only turn the currents to find the maximum torque angle.

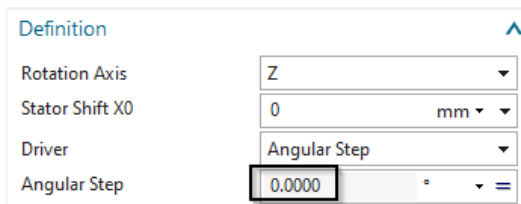

2. Solve the solution. (this takes about 3 minutes because of the nonlinear materials)
3. Show the torque result graph and indicate the first minimum.

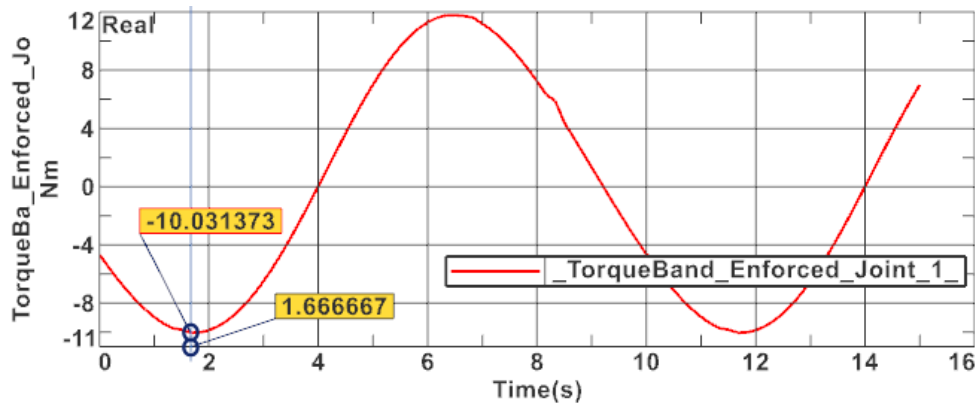

4. The torque shows a first minimum at 1.667 sec. Let's transfer this time to the corresponding rotor angle: Because 15 sec represent 90 degrees the minimum is at $1.667 * 90/15 = 10$ degrees.
5. Change the rotor to minimum torque start position:
 - Set the displayed part to the CAD master 'ElectricMotor.prt'
 - Expression p34 is responsible for the rotor angle. Change this from zero to 10 degrees.

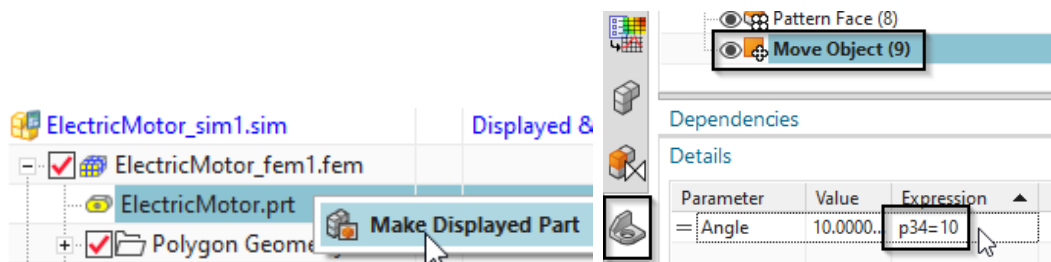

- Change to the Fem part. Press the Update button .
 - Change to the Sim file.
6. If the model does not converge, change the numerical settings to help the solution to converge better. We use a fixed relaxation instead of an adaptively controlled. Therefore, use right mouse button on the solution and 'Edit Solver Parameters'. In register 'Numeric' at box 'Nonlinear Magnetic Material' switch from 'Program Controlled' to 'Advanced Scheme (Default)'. Set the 'Relaxation Type' to 'Fixed Value'.

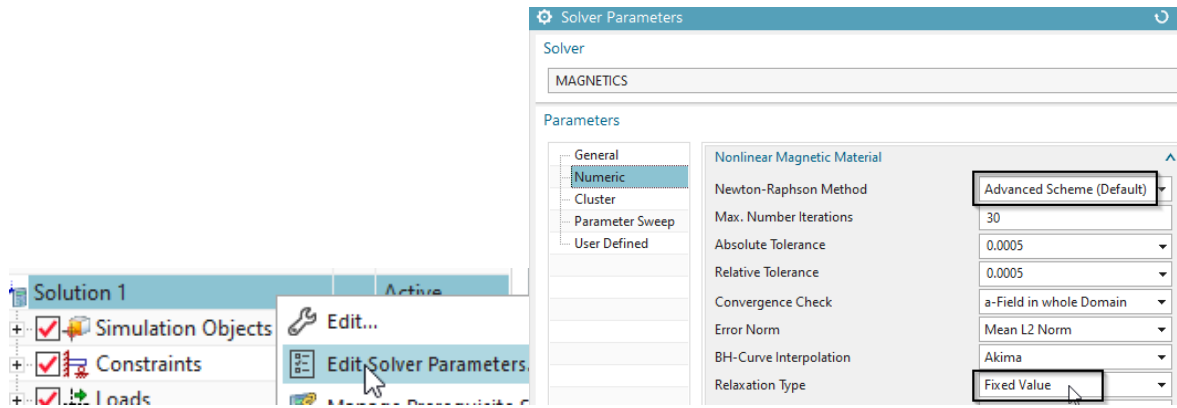

7. Rerun the solve and display the torque graph again. Verify that it now starts with minimum torque.

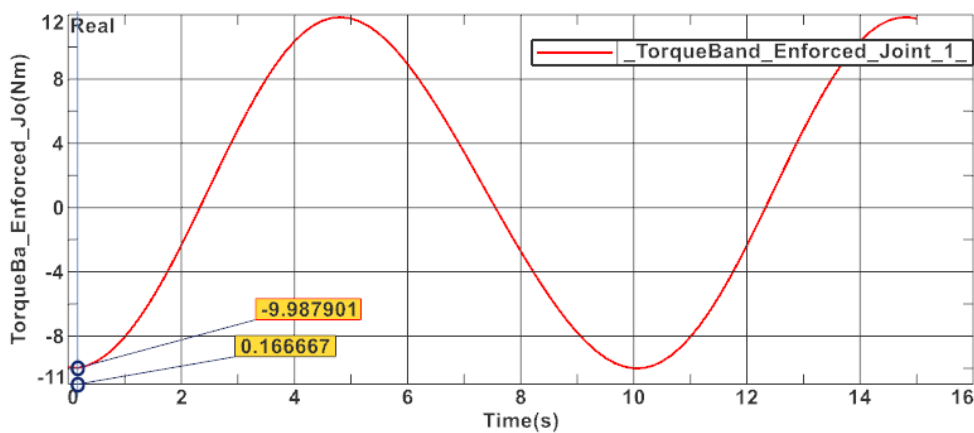

8. Close the graph display.

4.1.3 Analyze for Torque with Rotation

1. In the Enforced Motion, set the 'Angular Step' back to expression 'RotorStep'.
2. For a higher accuracy result of torque, decrease the tolerance in the Newton scheme: Go to 'Edit Solver Parameters', switch to register 'Numeric' and change the 'Absolute Tolerance' and 'Relative Tolerance' both from $5e-4$ (default) to $5e-5$.

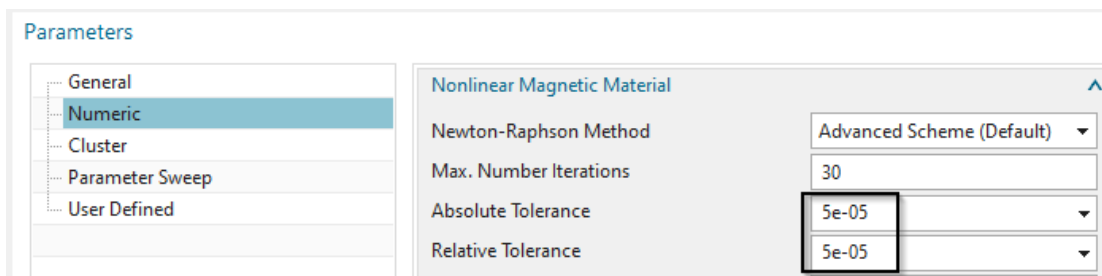

3. Solve the solution and display the torque graph again. It should look similar as the next picture.

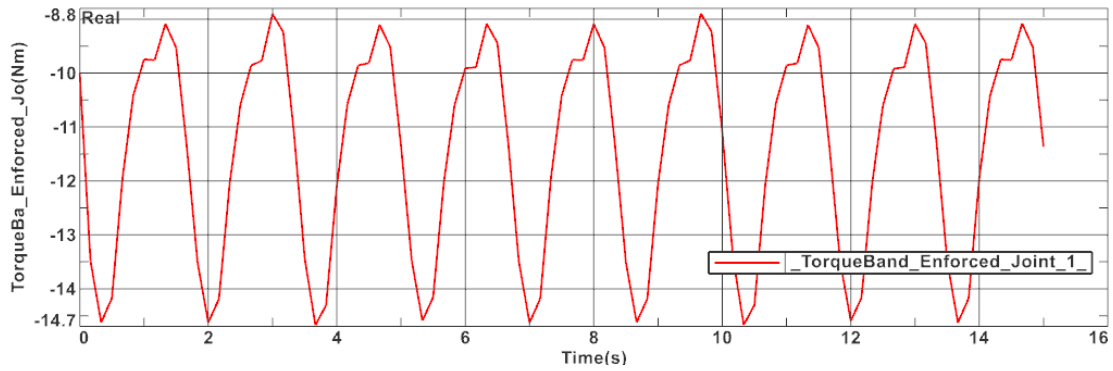

4. Close the AFU file.
5. Check for torque ripple: Use right mouse button on the torque graph and use the function 'Information'. In the information window there are minimum and maximum values as well as the mean value of the graph shown. The ripple is the difference between min and max.

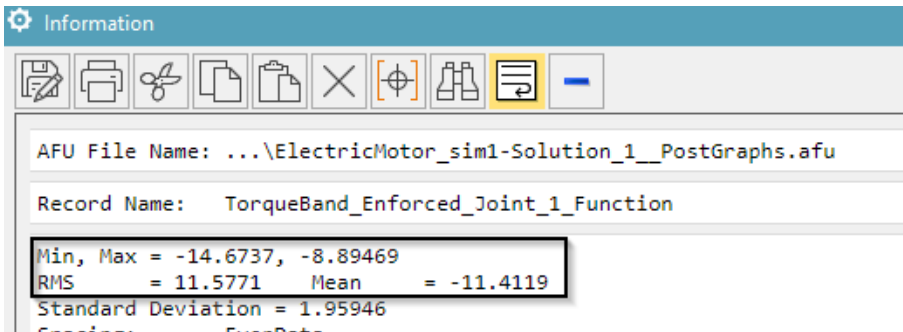

6. Display rotation: To show the motion of the rotor, first display a plot result. In 'Post View', register 'Deformation', activate 'Deformation'.

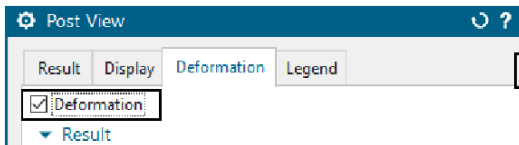

and then use the green buttons 'Next Iteration' $\leftarrow \rightarrow$. Alternatively, use the animation feature. $\leftarrow \rightarrow$.

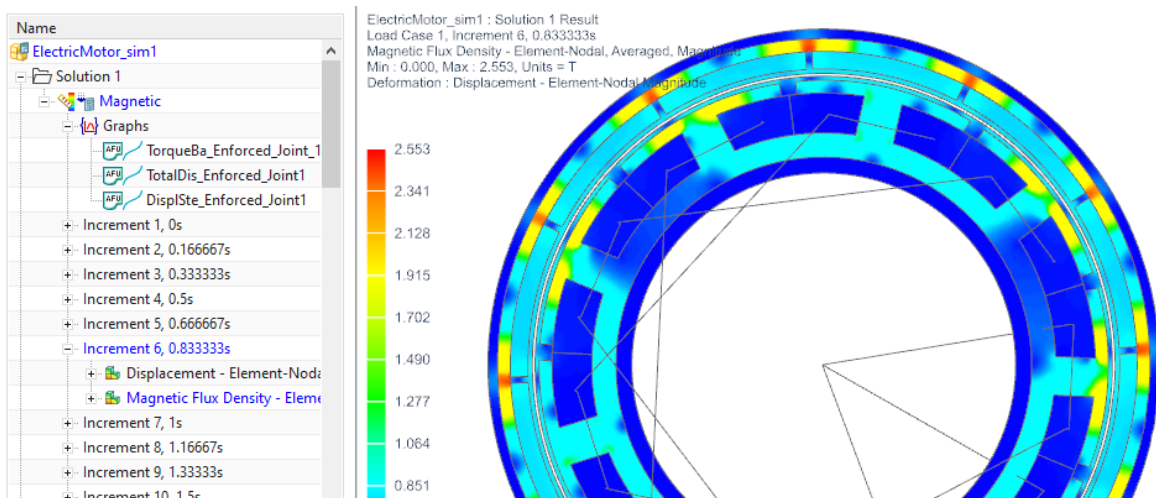

4.1.4 Analyze for Voltage in Phases

1. We now want to run the motor with 1000 turns per minute. So, change the expression 'SpeedMech' to 1000 rev/min. (Menu, Tools, Expressions)
2. To analyse for voltage, we want to run the motor with zero currents. So change also the expression 'CurrentAmplitude' to 0 A.

	↑ Name	Formula	Value	Units	Dimensionality
1	Default Group				
2				mm	Length
3	CurrentAm... 0		0 A	A	Electric Current
4	CurrentFr...	$(\text{Poles} * \text{SpeedMech} / 360) * (180.0 / \pi())$	100 Hz	Hz	Frequency
5	Poles	6	6		Unitless
6	RotorStep	-1	-1 °	°	Angle
7	SpeedMech 1000		1000 rev/min	rev/min	Angular Velocity
8	TimeIncre...	$-1 * \text{RotorStep} / \text{SpeedMech}$	0.0001666666666...	s	Time

3. We do not want to overwrite the existing solution. Thus, clone the solution (right mouse button on solution 1, 'Clone') and rename the new one to 'MagDyn1000Umin'.
4. Set the output requests as shown in the picture. The 'Circuit Voltage' request will calculate voltages in all circuit elements.

The screenshot shows the 'Solution' window with the following settings:

- Name: **MagDyn1000Umin**
- Solver: MAGNETICS
- Analysis Type: 2D or axisym Electromagnetics
- Solution Type: Magnetodynamic Transient

The 'Magnetodynamic Transient' window shows the following 'Output Requests' and 'Plot' settings:

- Output Requests:** Time Steps, Initial Conditions, Coupled Thermal, 2D.
- Plot:**
 - Magnetic Fluxdensity
 - Magnetic Fieldstrength
 - Current Density
 - Eddy Current Losses Density
 - Magnetic Potential (a-Pot)
 - Nodal Force - virtual
 - Nodal Moment - virtual
 - Lorentz Force
 - Displacement
 - Material Properties

The 'Table' window shows the following 'Plot' settings:

- Total Force - virtual
- Total Moment - virtual
- Total Lorentz Force
- RotorBand Torque - stresstensor
- RotorBand Force - stresstensor
- Fluxlinkage - Vectorpotential on Conductors
- Electrode Voltage
- Electrode Current
- Electrode Power
- Circuit Voltage**
- Circuit Current
- Circuit Power
- Eddy Current Losses
- Hysteresis Loss - steinmetz
- Eddy Current Loss - steinmetz
- Excess Loss - steinmetz
- Motion Data
- FFT Tables
- Motor Efficiency

5. For the measurement of voltage between two phases you create a new current of type 'On 1D-Circuits' with zero amperes between the desired network points. Use for instance the two points U and V. Name this load 'Sensor UV Phase'.

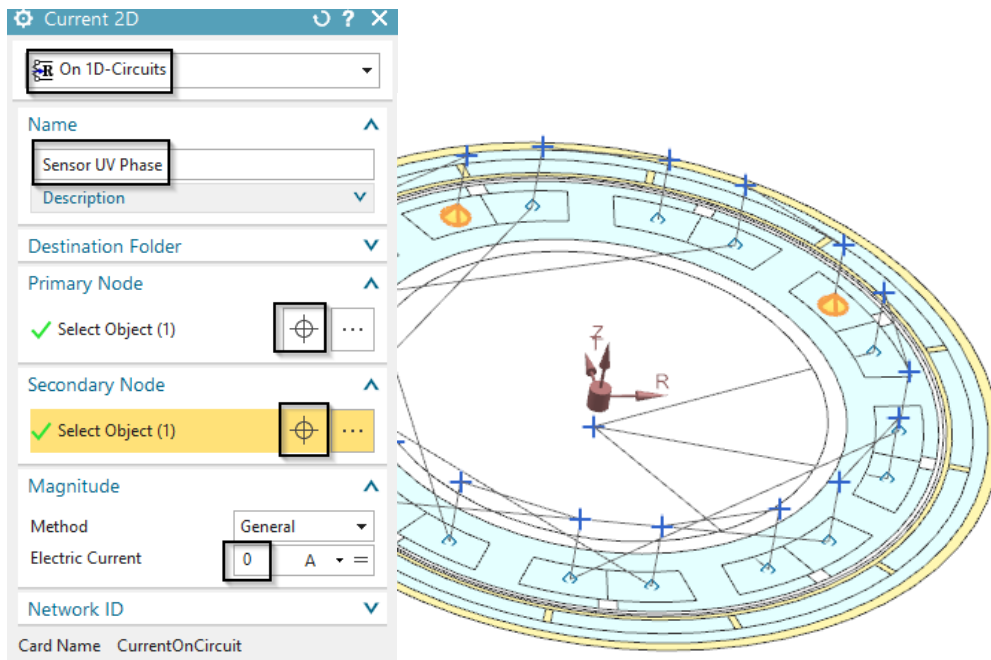

6. Solve the new solution

7. Display the graph results for the voltages in the three phases and the new sensor. This should look like in the following picture.

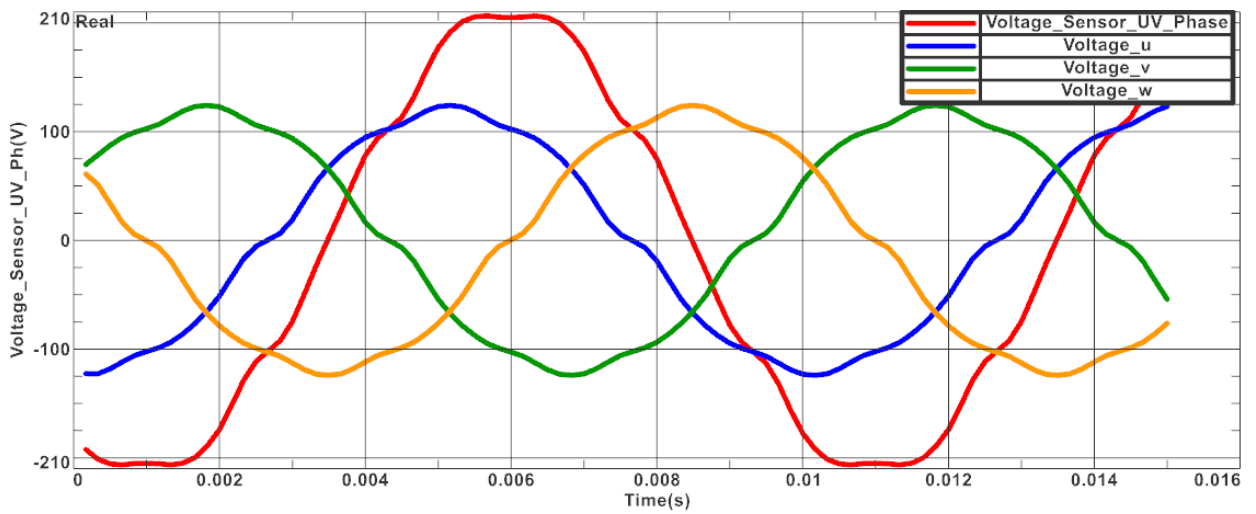

4.1.5 Parameter Optimization with HEEDS

In the last part of this tutorial, we intend to optimize the permanent magnet synchronous motor. Therefore, we use the additional program Design Space Exploration, which is a limited version of HEEDS, that can be used only with Simcenter 3D. The goal of this optimization is to maximize the RMS of the Torque and to minimize the Ripple. We thus adjust the Outside Diameter of the Rotor, the Inside Diameter of the Coil, the Width of the Slot Opening and the Width of the Teeth.

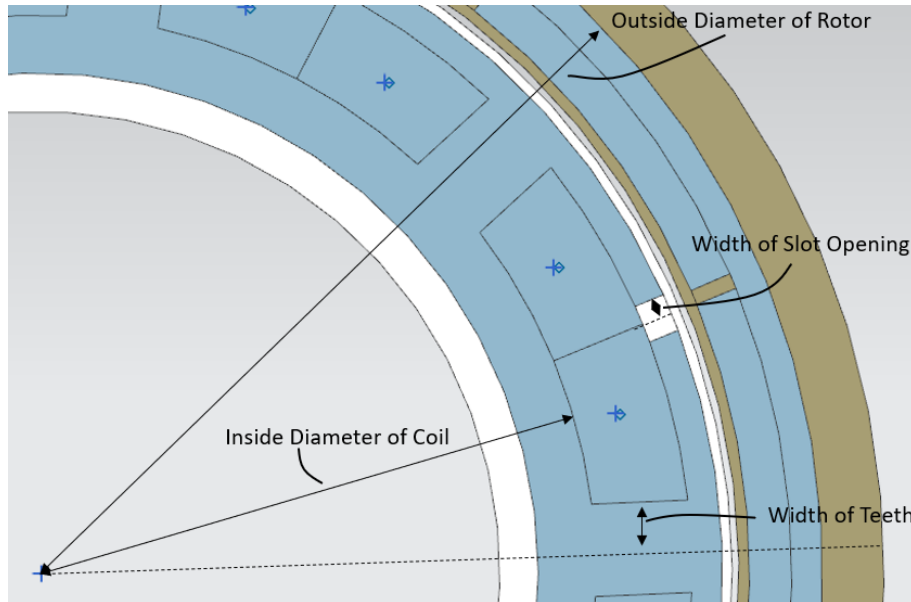

Before setting up the Optimization in HEEDS, we need to make sure that all necessary results are available.

1. Prepare the Model in NX

- Download the model files for this tutorial from the following link:
<https://www.magnetics.de/downloads/Tutorials/6.CouplMotion/6.4ElectricMotor.zip>
- Open the file 'ElectricMotor_sim1.sim'. Hint: You may also use the solution that was created in the previous section.
- Change to the Part file and set the expression p18 to 220 mm.
- Switch to the Sim file and set the 'Result Graphs (afu)' within the 'Solver Parameters' to 'Create, keep txt files' and activate 'Solve in Foreground'.

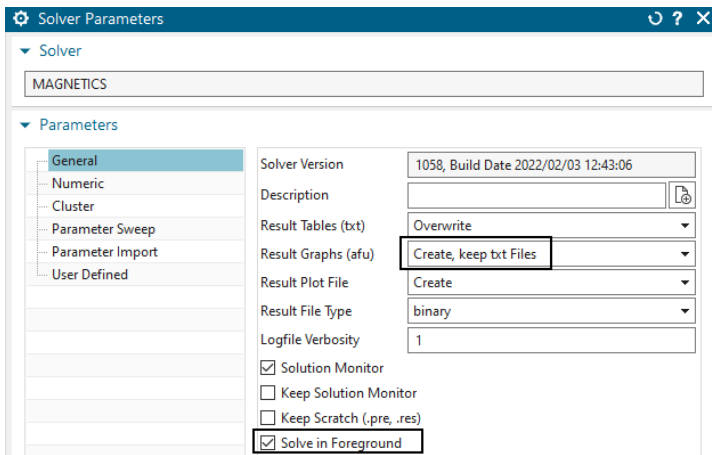

- Solve the Solution once to create the txt files.
- Now import three Parameters in the 'Solver Parameters' menu.
- Choose for every Parameter the txt file 'ElectricMotor_sim1-MagDyn1000Umin.RotorTorque.txt' and copy it into the window.
- Set up the Parameter Imports as shown in the picture below.
- Hints: The Torques are shown in the fourth column of the file. As the lines in this case are negative, we set the Line Option for the maximum Torque to the Minimum Value.

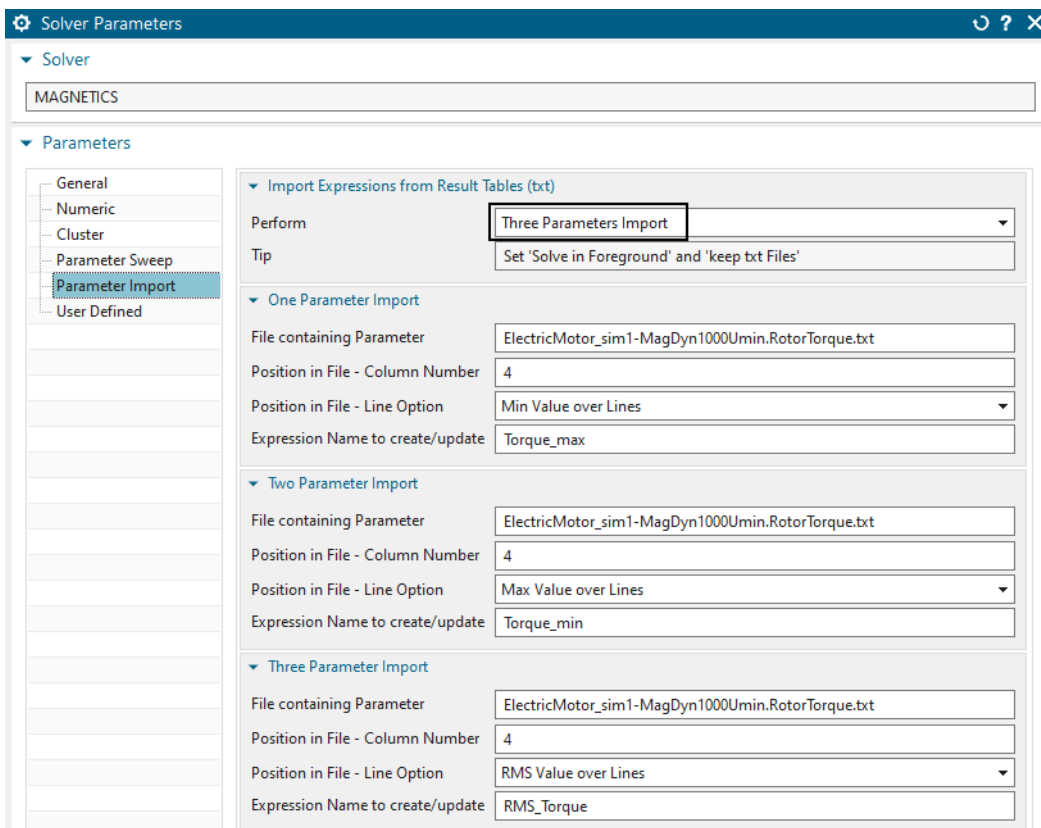

- Solve the Model again and save it before changing to Design Space Exploration (HEEDS).

2. Set up the HEEDS run.

- Open HEEDS and save your HEEDS-project in the same folder, were you also have saved the Sim file. Name it ‘ElectricMotor_HEEDS’.
- In order to minimize the solution time, set ‘Num. designs to execute simultaneously’ to five.

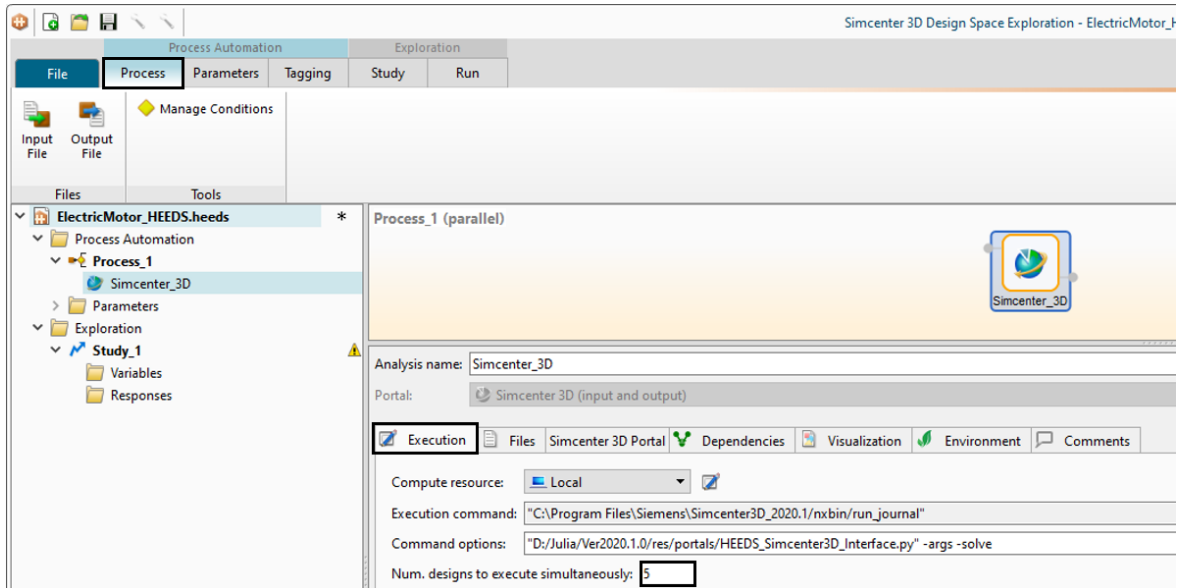

- Input the Sim file which you have prepared in advance. HEEDS will then automatically upload the Fem File, the prt file and also create the output file. After loading, continue without ‘Auto Tagging’. Click on ‘Process’ and ‘Input File’.

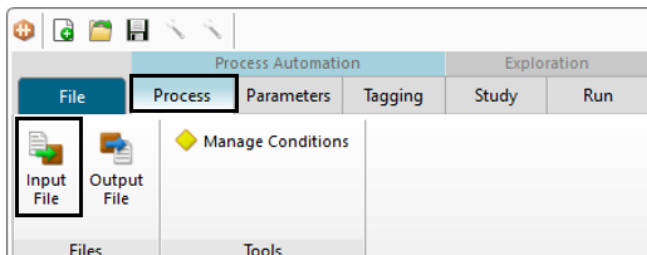

- The next step is to create the ‘Variables’. Click on ‘Parameters’ and ‘Create Variable’.

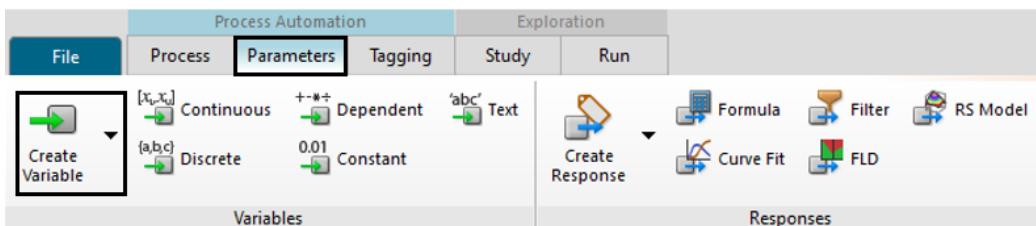

- Create the variables as shown in the picture below. HEEDS will adjust these variables to optimize the objectives. In this example we have chosen geometric variables (see below fig.).
- Hint: You always define a minimal value, a maximum value and the baseline value, which is set up in your NX model and defines the first Design, the so called ‘Baseline Design’.

	Variable Name	Type	Min	Baseline	Max	Resolution
1	Outside_Diameter_of_Rotor	Continuous	200	204	210	101
2	Inside_Diameter_of_Coil	Continuous	68	72,5	75	101
3	Width_of_Teeth	Continuous	3	6	10	101
4	Width_of_Slot_Opening	Continuous	0,5	2,5	5	101

- The next step is to create the responses. Therefore, click on ‘Parameters’ and ‘Create Responses’.

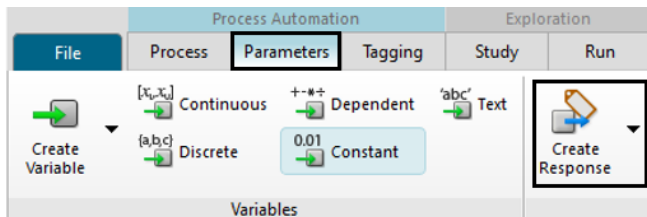

- Create the ‘Responses’ as shown in the picture below.
- Hints: In this example the minimal and the maximal torque is printed out with a negative value. To calculate the torque-ripple we want to use the value of these responses by creating new responses and calculating the values. Then we will use the type ‘Formula’ and input the calculation. By clicking ‘Apply’ we add the formula to the response.

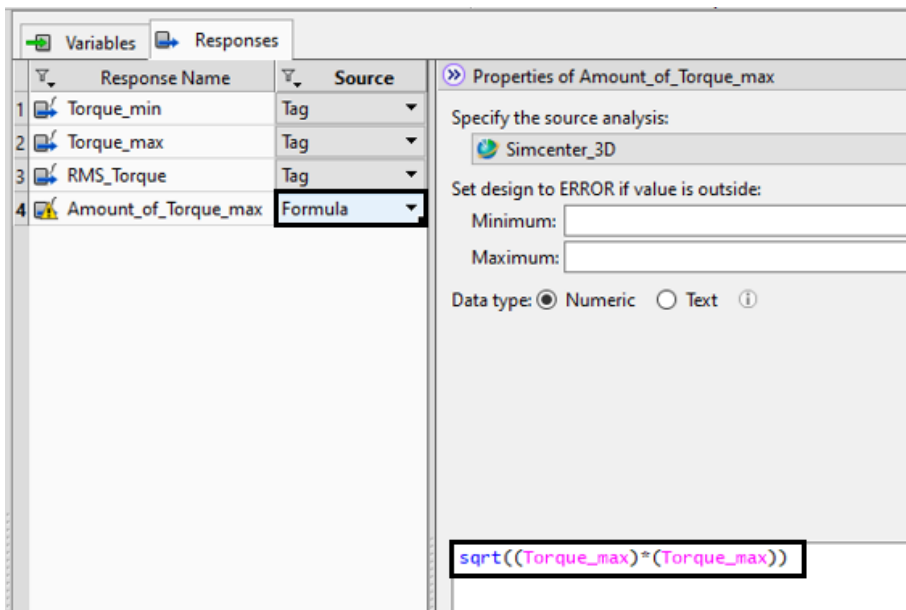

- Create a formula also for the ripple. Hint: one response of the solution must be added to generate results. Therefore, the Flux Density is also created as a response.
- Your list of responses should look like the one in the picture below.

	Response Name	Source	Formula	Comment
1	Torque_min	Tag		
2	Torque_max	Tag		
3	RMS_Torque	Tag		1. Objective: Maximize
4	Amount_of_Torque_max	Formula	$\sqrt{(\text{Torque_max}) * (\text{Torque_max})}$	
5	Amount_of_Torque_min	Formula	$\sqrt{(\text{Torque_min}) * (\text{Torque_min})}$	
6	Ripple	Formula	$\text{Amount_of_Torque_max} - \text{Amount_of_Torque_min}$	2. Objective: Minimize
7	Flux_Density	Tag		

- Now follows the part of 'Tagging'. Here, we will connect the variables and the responses to our Input File and Output File. First, choose the input file by clicking on the button in the picture below.

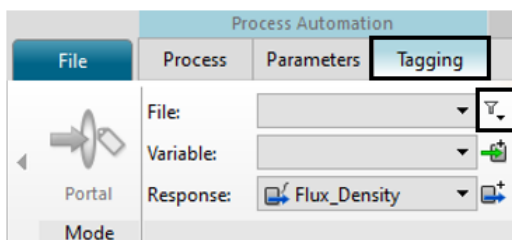

- Choose the Sim file marked green as input file and 'Tag' the variables with the 'CAD_Expressions'.
- Hints: To 'Tag' a variable choose it from the list of variables (top), click on it in the list of expressions and tag it with clicking on the button 'Tag'.

Input Type	Part	Expression	Value
CAD_Expressions	ElectricMotor	Outside_Diameter	178
		Band_Inside_Diameter	180.5
		Band_Outside_Diameter	182.25
		Inside_Diameter	130
		Inside_Diameter_of_Coil	145/2
		Inside_Diameter_of_Magnets	185
		Inside_Diameter_of_Rotor	196
		Outside_Diameter_of_Rotor	204
		Outside_Radius_of_Coil	170/2
		Width_of_Slot_Openings	5/2
		Width_of_Teeth	12/2

- After tagging every variable the list should look like the one in the picture below.

	Parameter	Mode	Data	Format
1	Outside_Diameter_of_Rotor	Portal	CAD_Expressions.ElectricMotor.Outside_Diameter_of_Rotor	Default
2	Inside_Diameter_of_Coil	Portal	CAD_Expressions.ElectricMotor.Inside_Diameter_of_Coil	Default
3	Width_of_Teeth	Portal	CAD_Expressions.ElectricMotor.Width_of_Teeth	Default
4	Width_of_Slot_Opening	Portal	CAD_Expressions.ElectricMotor.Width_of_Slot_Openings	Default

- Do the same with the responses. Choose the Sim file marked blue as Output File and tag the Torque_max, the Torque_min and the RMS_Torque from the list of 'CAE_Expressions'.
- Choose the Flux_Density in the list of the solution and set the filter to 'Max' to get the maximum value.

- Afterwards, the list of tagged responses should look like the one in the picture below.

	Parameter	Mode	Data	Format
1	Torque_min	Portal	CAE_Expressions.ElectricMotor_sim1.Torque_min	Default
2	Torque_max	Portal	CAE_Expressions.ElectricMotor_sim1.Torque_max	Default
3	RMS_Torque	Portal	CAE_Expressions.ElectricMotor_sim1.RMS_Torque	Default
4	Flux_Density	Portal	Solutions.CircuitVoltage.Magnetic Flux Density - Element-Nodal.Magnitude (Filter=3 System=AbsoluteRectangular iter=all id=all #System=AbsoluteRectangular)	Default

- The part of tagging is now done and we will set up a study in the 'Study' tab.
- Choose the 'Multiple objective tradeoff study (Pareto Front)' as 'Hybrid Adaptive Method' and set up the 'Method Properties' as shown in the picture below.
- Hint: We choose a minimum value of the evaluations and the archive size to reduce the time of solving the run to a minimum. For the creation of more designs you can choose a higher number.

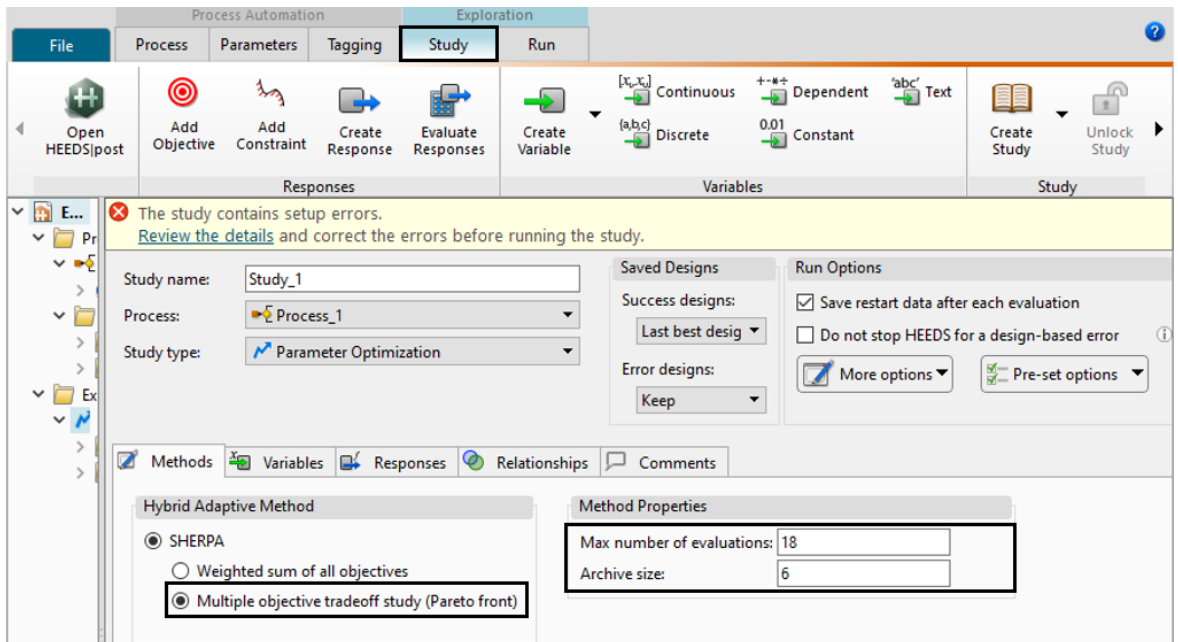

- In the next step we will define the two objectives.

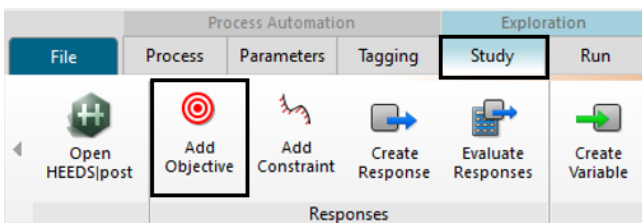

- Choose the response RMS_Torque as first objective and maximize the value. The second objective will be the ripple. Choose it out of the list and set the option to 'Minimize Value'.
- Afterwards it should look like in the picture below.

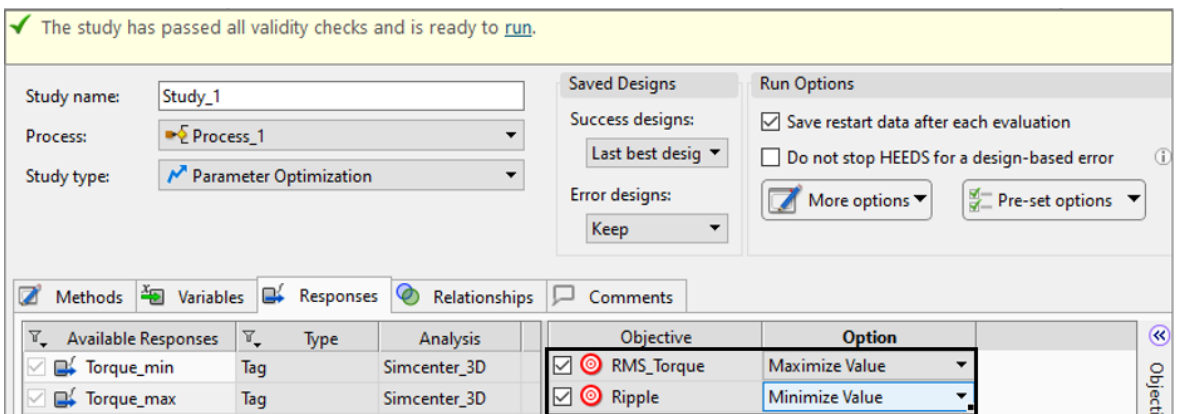

- The setup of the study in HEEDS is done. Save your project.
- Run the study by clicking on the button 'Run' in the run tab.

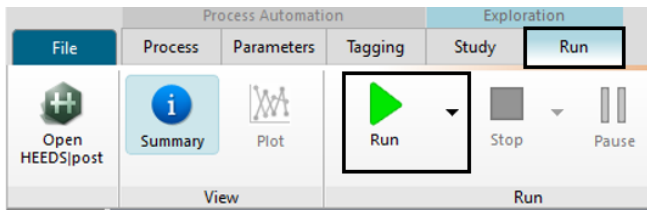

- It will take HEEDS about 45 min to create the designs.
- We then want to do some post-processing to evaluate the results and to choose the best design. To this end open 'HEEDS post'.

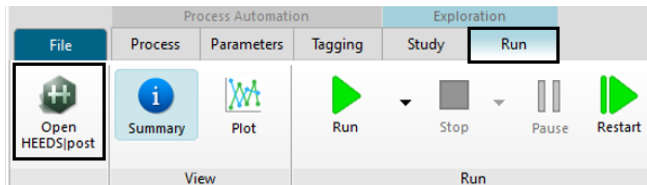

- In order to find the best design, we create a 'Design Table'.

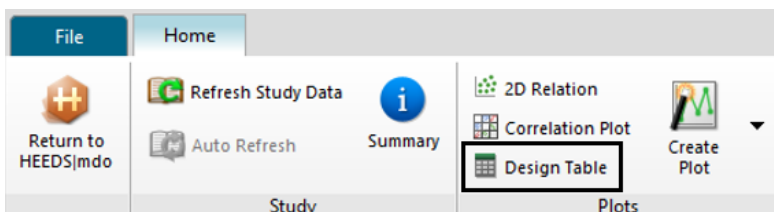

- Choose all variables, the responses ripple and the RMS_Torque from the list (picture below).

Design Table

Displays the design data in a spreadsheet format

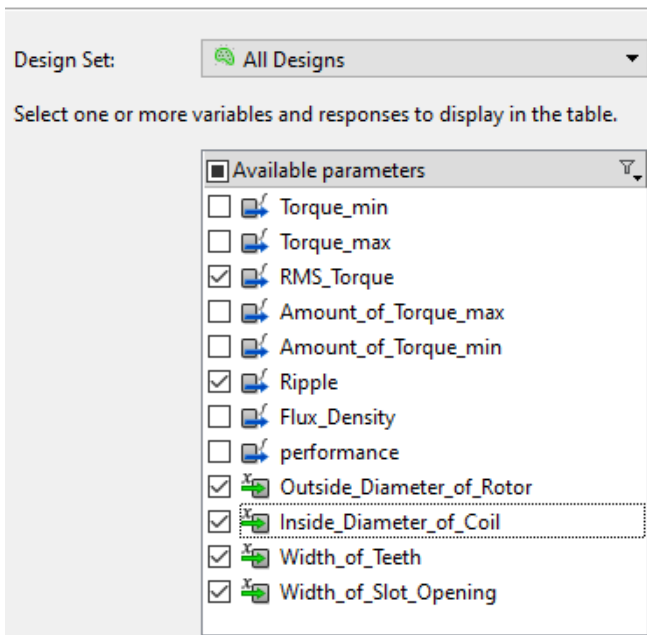

- Create the table with 'Finish'.
- Out of the 18 designs created, we choose the one design with the smallest ripple value and the highest RMS_Torque. With design 6 we can reduce the ripple by 25 % and

the RMS_Torque increases slightly compared to the Baseline Design. Thus, the motor model definitely is optimized.

Study_1: DesignTable_4						
Design ID	RMS_Torque	Ripple	Outside_Diameter_of_Rotor	Inside_Diameter_of_Coil	Width_of_Teeth	Width_of_Slot_Opening
1	11,5613	6,19362	204	72,5	6	2,5
2	15,9914	18,611	209,1	72,48	6,85	5
3	10,2333	1,0946	203,6	69,26	8,11	0,905
4	14,3251	10,1646	210	71,15	7,48	1,715
5	8,98279	3,52498	201,8	68	5,52	3,785
6	11,9023	3,99088	207,3	74,37	4,26	2,12
7	9,36315	2,23324	200,9	73,74	6,15	1,31
8	13,631	10,874	205,5	75	8,74	2,975
9	12,0358	6,78733	206,4	68,63	9,37	4,19
10	11,185	8,66632	202,7	73,11	4,89	4,595
11	8,42361	1,77224	204,5	70,52	3	0,5
12	11,8624	7,24391	208,2	69,89	3,63	3,38
13	11,9988	4,66885	207	74,16	4,4	2,345
14	9,81763	1,95061	202,6	69,68	7,34	0,68
15	9,55337	1,28707	203,3	70,8	4,05	1,04
16	9,26617	3,17615	201,8	68,28	5,52	3,785
17	15,6225	16,4483	210	71,15	7,48	3,965
18	15,7937	17,1555	210	70,94	7,76	4,19

The tutorial is completed.

5 Tutorial 4

5.1 AFEM Modeling of Motors

This tutorial shows how to model electric motors using the NX assembly fem method. This method allows to create meshes only for parts of the whole motor and then use those meshes multiple times in an assembly (AFEM). The next picture shows this situation: The file Stator_fem1.fem is created only once, but used several times in the AFEM file Motor_asm_assyfem1.afm.

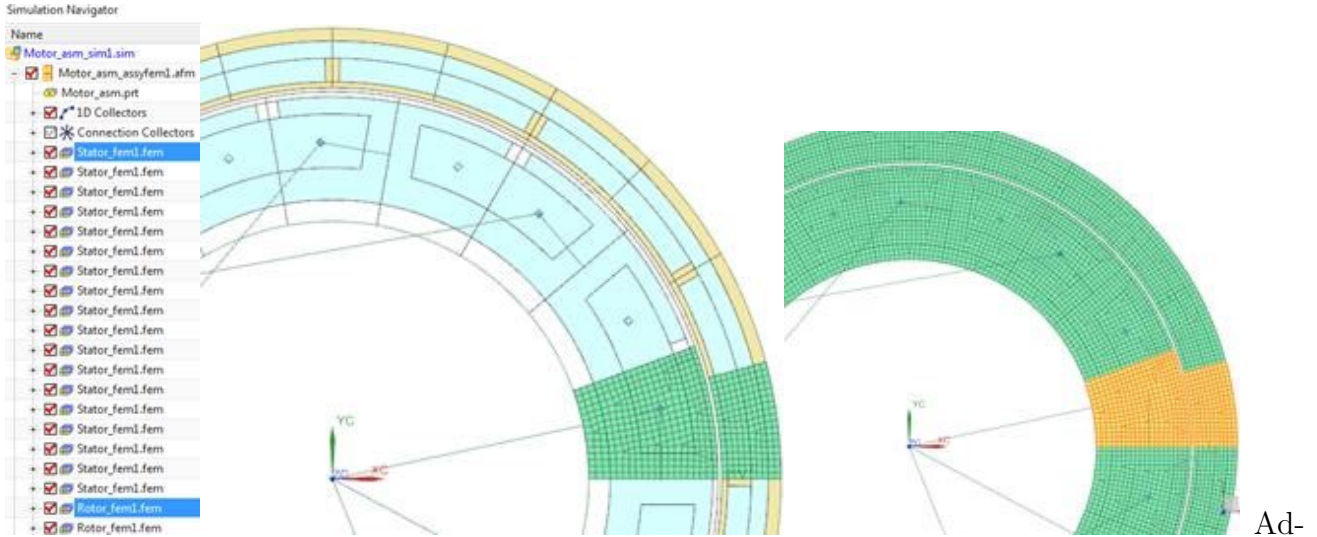

Advantages of this method are

- The overall mesh becomes perfectly regular because the same mesh is used for each segment. Because of this there will also be more precise results.
- Less meshing effort
- Less data volume

You can find the already completed model of the simple motor in this tutorial folder. Go through the following steps to become familiar with the main features:

1. Download the model files for this tutorial from the following link:
<https://www.magnetics.de/downloads/Tutorials/6.CouplMotion/6.5ElectricMotorAFEM.zip>
2. Open the file Motor_asm_sim1.sim.
3. Make the CAD assembly part Motor_asm.prt the displayed part.
4. Check in the assembly navigator the structure of this CAD assembly. It contains one segment of the rotor and one of the stator.

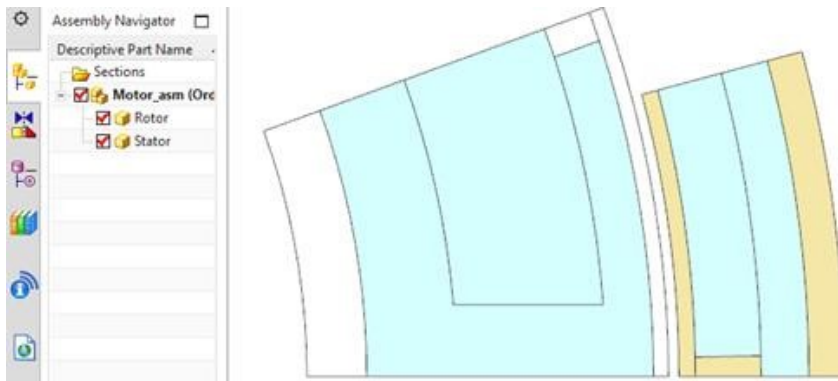

5. Change the window to the file Rotor_fem1.fem. Check the contents of this file.

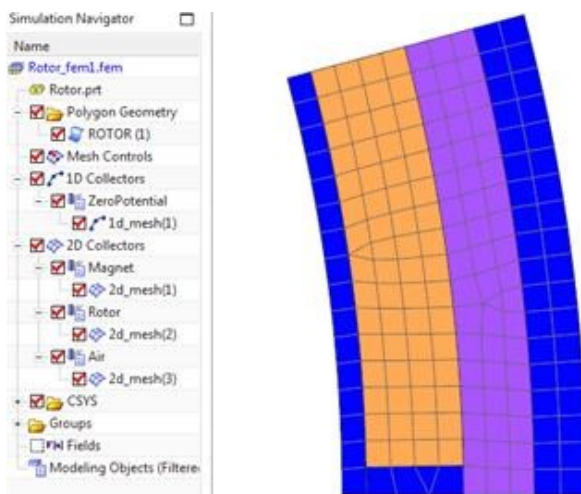

- There is a 1D mesh at the outer border. This is applied to a Physical of type ZeroPotential. Therefore no additional constraint of this type is necessary anymore in the Sim file.
- The Magnet has permanent magnet material and a cylindrical coordinate system as usual. Later in the Sim file we will see that every second magnet physical is overwritten and because of the need for opposing magnet directions.

6. Change the window to the file Stator_fem1.fem. Check the contents of this file.

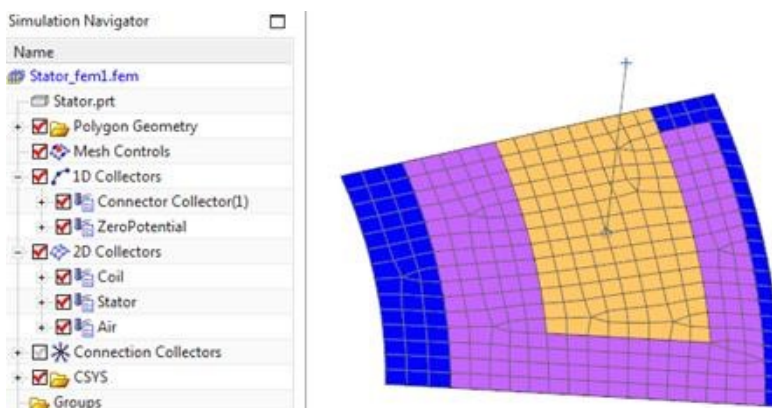

- Again there is a 1D mesh at the inner border with Physical of type ZeroPotential. Therefore no additional constraint of this type is necessary anymore in the Sim file.

- There is a 1D Connector mesh. This is later used to implement the network. The advantage is that this Connector must only be created once.

7. Change the window to the file Motor_asm_assyfem1.afm. Check the contents of this file

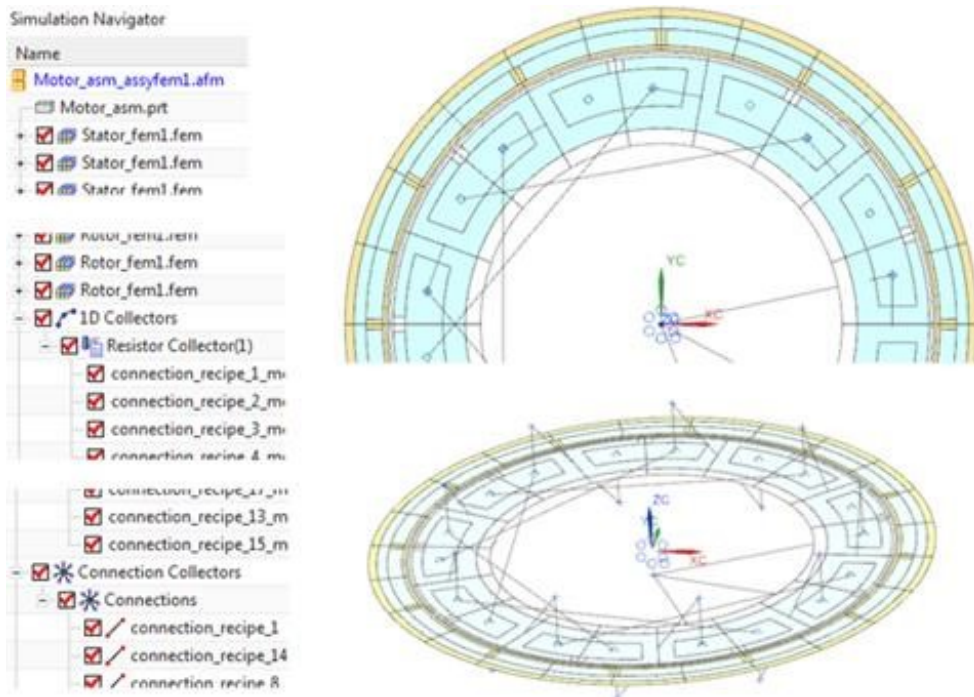

- Notice that there are 18 Stator_fem1.fem files included in the assembly fem file. For best exploitation of symmetry every second of those meshes is positioned upside down. This method has the advantage of perfectly matching nodes at borders. Next picture shows such a couple of two meshes.

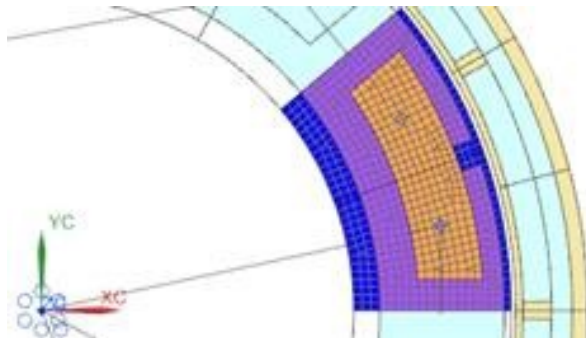

- Notice the 1D resistor elements. They form the circuit network to couple the coil connectors.
- Although nodes at borders are perfectly matching, they must be merged. In this model nodes are already merged, but in a new model you must check for duplicate nodes using the function Duplicate Nodes .
- Like always in NX assembly fem you must use the Assembly Label Manager to resolve conflicts in labeling. Simply press 'Automatically Resolve' in the Assembly Label Manager.

8. Change the window to the Sim file Motor_asm_sim1.sim. Check the contents of this file.

- Check the solutions in the Sim file. There is one static and one transient solution included. Loads and simulation objects are set up in the same way as without assembly fem. There is nothing special for afems now anymore.

The tutorial is complete.

6 Tutorial 5

6.1 Asynchron (Induction) Motor Analysis

In this tutorial an induction or asynchronous motor is analysed. In part one we use a frequency domain analysis in order to provide quick results. Such frequency domain analysis provides settled situations of dynamic problems with harmonic behaviour. However, the frequency domain analysis also has some disadvantages, such as: nonlinear material properties can be simulated only with reduced accuracy; and same-wise also no permanent magnets are possible to be simulated.

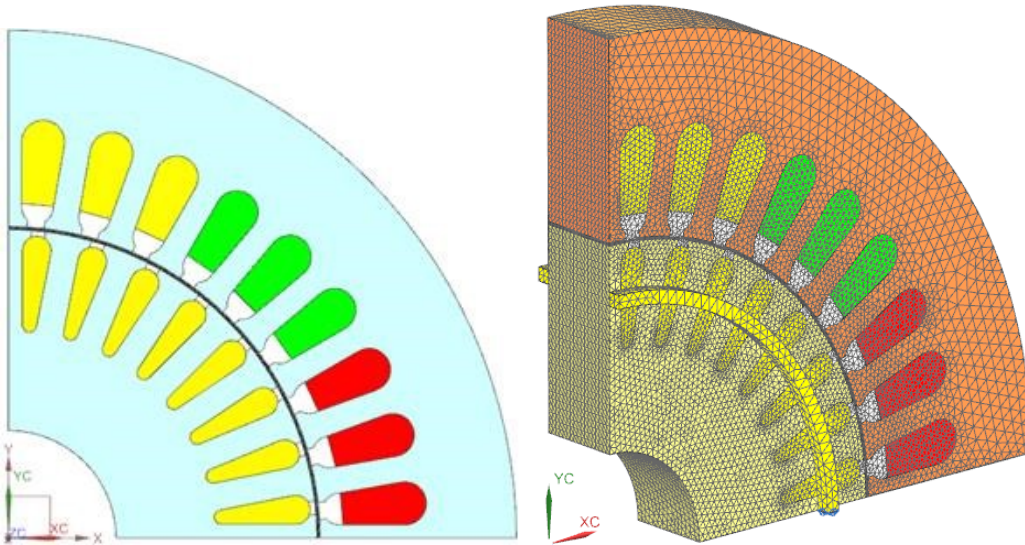

In a second part we will analyse the temperatures in the motor. Herein, we will perform a sweep over the full operating range.

In a third part we will use a time domain analysis to solve this problem at one operating point. We will see that the resulting torque agrees nicely to the prior frequency analysis. In time domain we can include accurate nonlinear material effects; also the inclusion of permanent magnets would be possible, but is not needed here. The time domain analysis works quite similar as the prior examples of this document.

After that we want to use time domain analysis to investigate the starting behaviour of the motor. We find that the resulting velocity after some time agrees to the synchronous velocity.

Finally we show a 3D model of the induction motor with simulation in frequency domain. This simulation shows very similar results as the 2D simulation of part one but it would additionally allow to study end effects and other 3D specific effects.

In the frequency domain solutions results come out without rotor motion. Therefore they depend also on the relative position of rotor to stator bars. To check for this influence one could simulate at different rotor angle positions. The 2D CAD model has an expression to control that.

6.1.1 Basic Model Setup

For the basic setup follow these steps:

1. Download the model files for this tutorial from the following link:
<https://www.magnetics.de/downloads/Tutorials/6.CouplMotion/6.6InductionMotor3kW.zip>
2. Open the file InductionMotor_3kW.prt.
3. Notice the air gap in the next picture: There is one layer for the inner mesh, one for the outer mesh and the middle layer is without geometry. Here the solver will create a Moving Band mesh by himself.

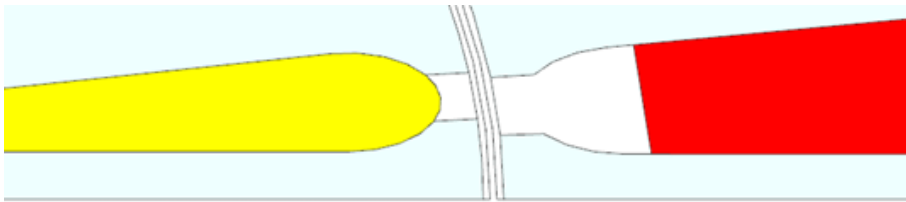

4. Create a new Sim and Fem file.
5. Use solver MAGNETICS, Analysis type 2D and Solution Type 'Magnetodynamics Frequency'.
6. Name the solution 'MagDynFreq1'.
7. Set the Output Requests as shown below.

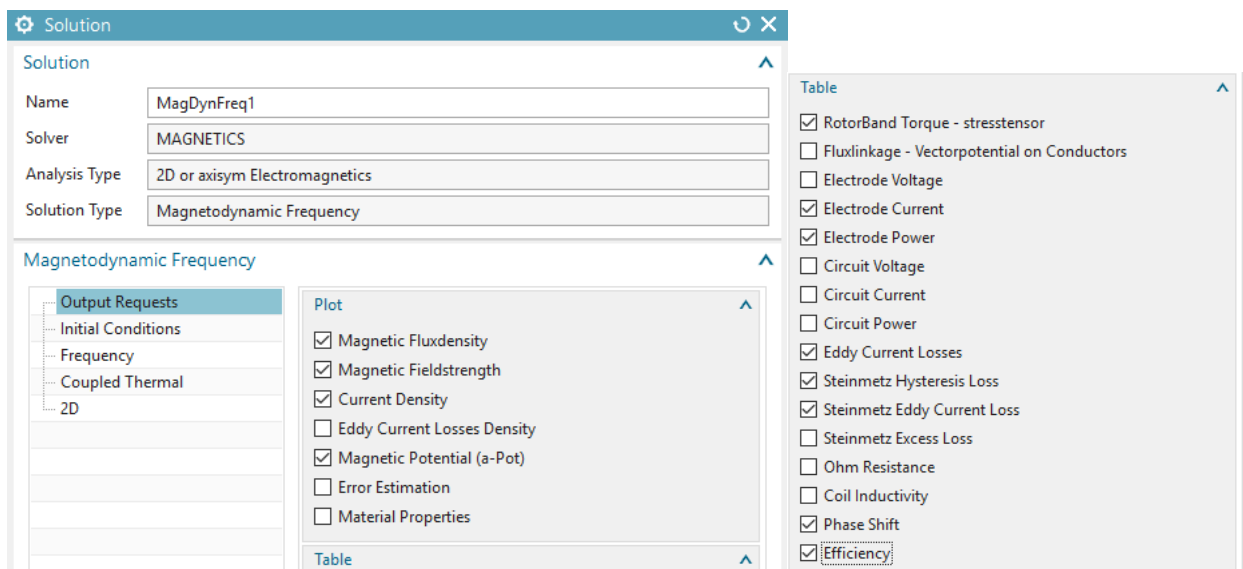

8. Some remarks to the requested outputs:

- RotorBand Torque – stresstensor:
This is the usual result for the apparent torque in the air gap. It is computed by the Maxwell Stresstensor method.

- **Electrode Current:**
The resulting electric current on voltage loaded faces (electrodes).
- **Electrode Power:**
This result will compute voltage times electric current on all faces with loads (complex multiplication). The real part of this result is the active power and the imaginary part is the reactive power.
- **Eddy Current Losses:**
This result will compute power losses that result from eddy currents and ohmic resistance. Also lamination effects will be taken into account.
- **Steinmetz Hysteresis Loss:**
Based on the material property K_h , the frequency and the magnetic induction b this result computes losses on all parts with $K_h > 0$ using the Steinmetz formula.
- **Steinmetz Eddy Current Loss:**
Similar as above, but using the material property K_c and the corresponding Steinmetz formula. This result is alternative to the above Eddy Current Losses.
- **Phase Shift:**
This result computes the angle between electric current and voltage on each load. This is also known as Power Factor.
- **Efficiency:**
The Efficiency result computes output power divided by input power. Output power is computed by the resulting torque times rotor speed. Input power is computed by the active power on electrodes or circuits.

9. Set the thickness as shown in the '2D' options.

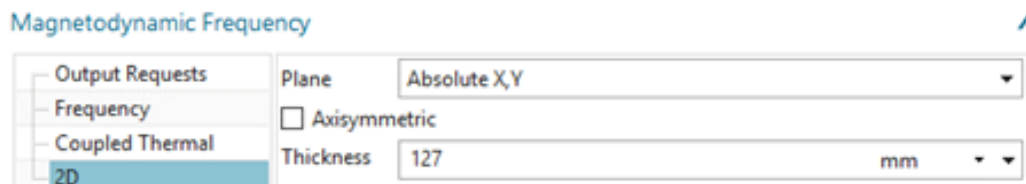

10. And the options for Frequency Domain: The forcing frequency defines the velocity of the rotating field of the coils. 50 Hz divided by the number of poles (4) gives defines
Hint: The Setting 'Conductivity Type': 'Slip Dependent' is basis for the used induction motor analysis method.

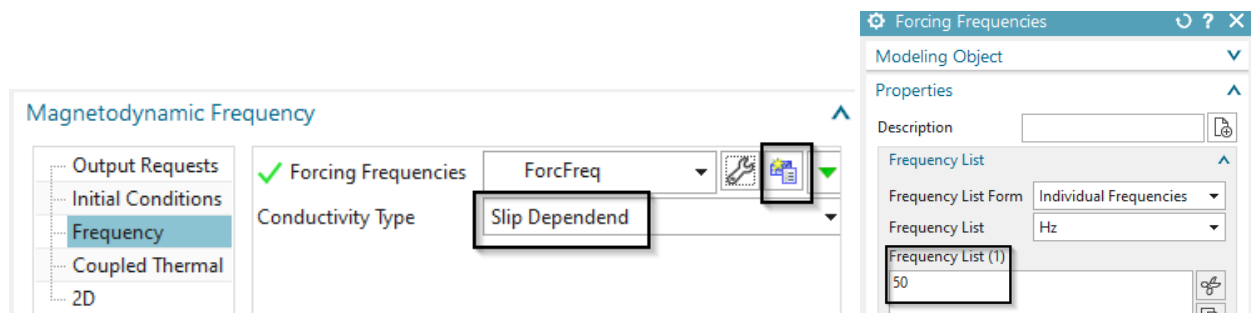

11. Click Ok.

12. Switch to the FEM file

13. Create Mesh Controls  :

- Assign a number of 28 elements on the shown two linear edges:

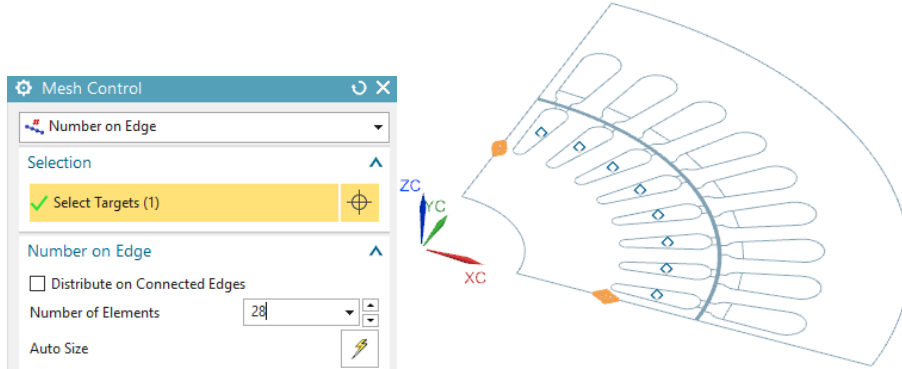

- Assign a number of 20 elements on these two edges:

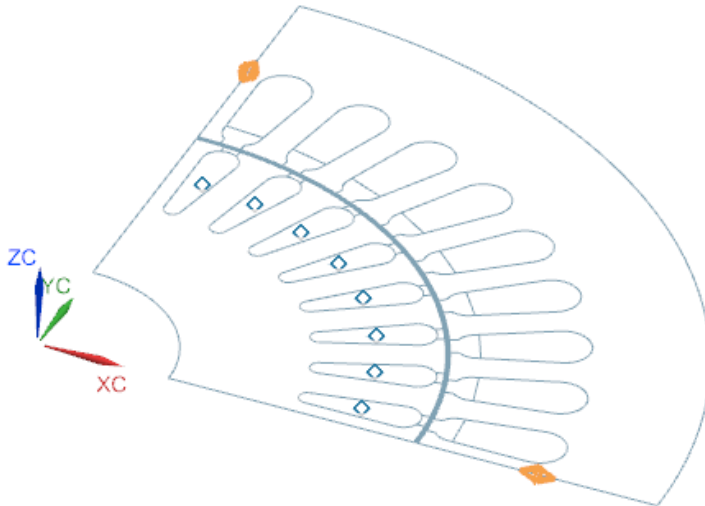

- Assign a number of 180 elements on the two edges of the Moving Band.

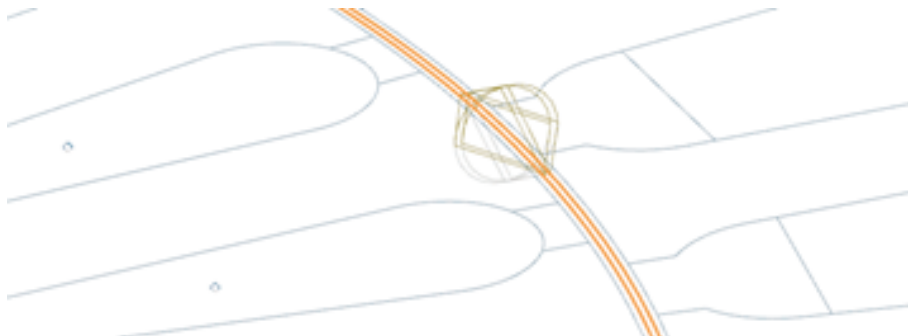

14. Mesh the inner part of the air gap (element size 0.5 mm). Create a FluidPhysical and assign 'Air' from the Magnetics material library as shown in the picture.

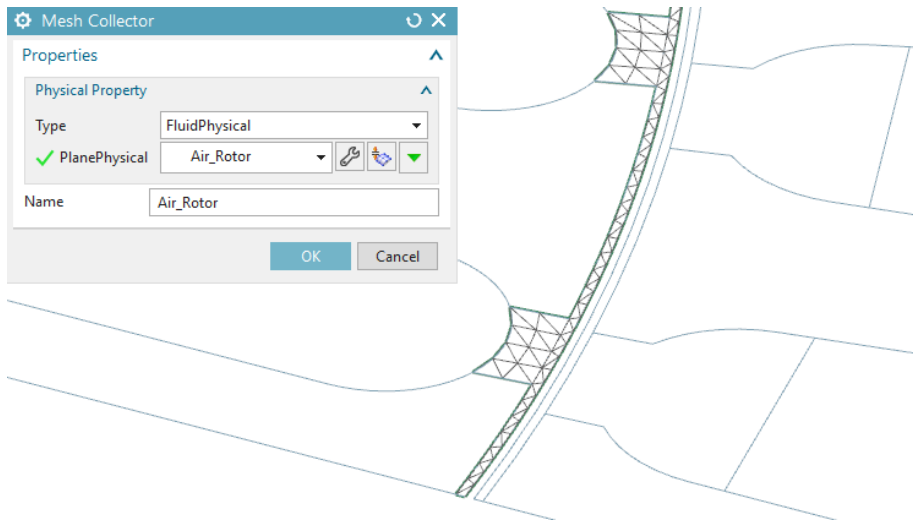

15. Mesh the outer part of the air gap (0.5 mm) and also use FluidPhysical and 'Air'.

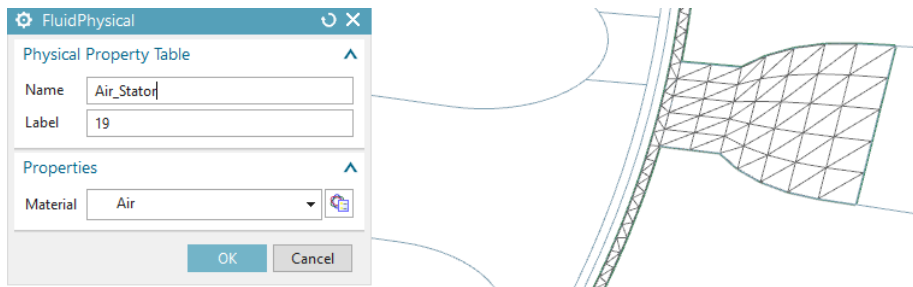

16. Mesh the coil faces (1 mm) for phase U and use the shown settings.

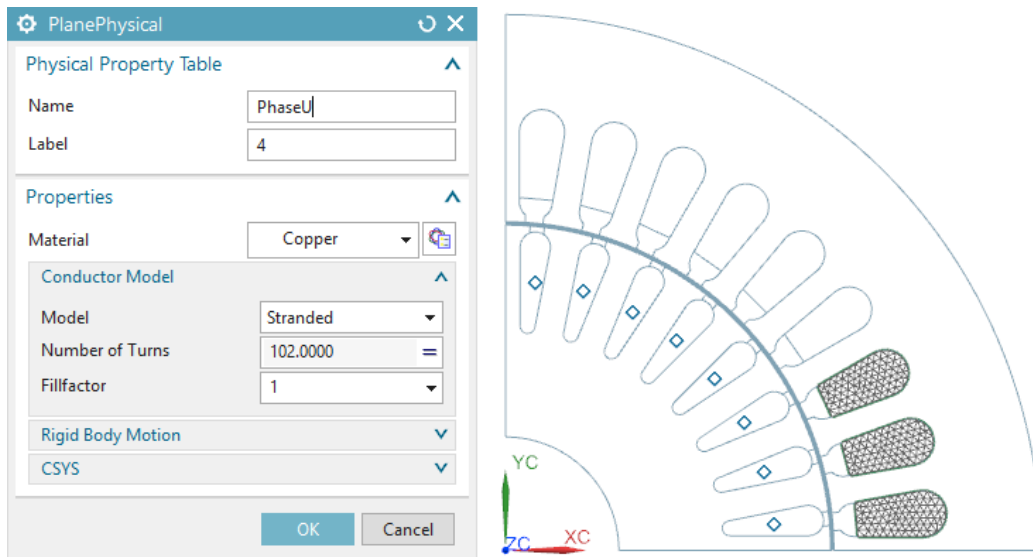

17. Mesh the coil faces for phase V and use these settings.

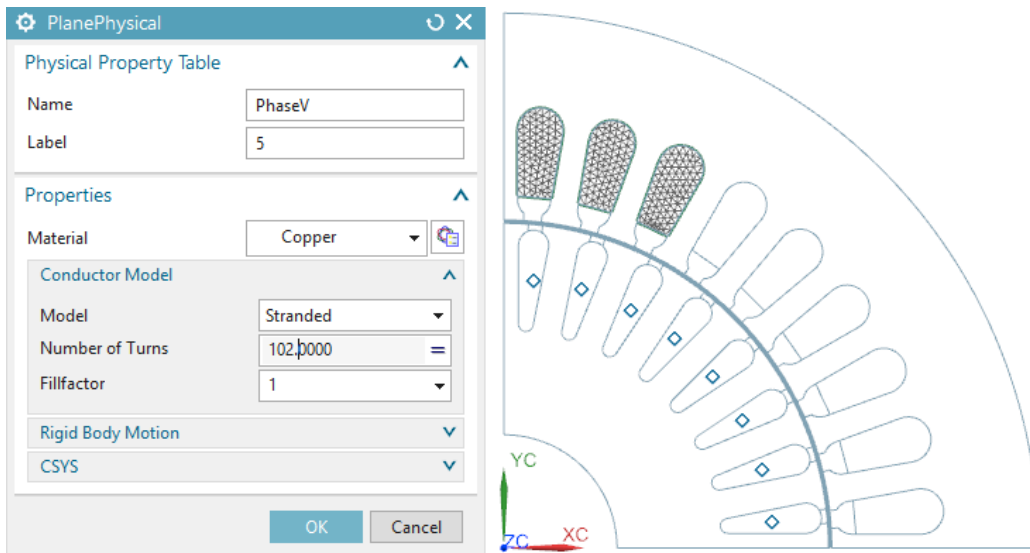

18. Mesh the coil faces for phase W and use these settings.

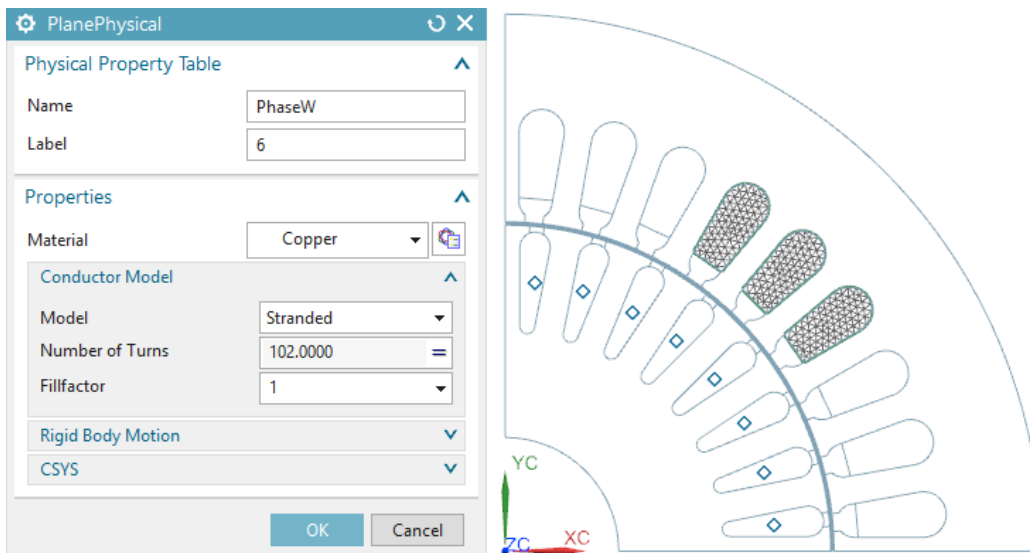

19. Mesh the bars (1 mm). Put them all in one physical or even in one mesh. This will simulate the effect of connections at top and bottom. So, in this case there is no need for an additional circuit network to couple the bars. Use the shown settings. Create a new material for the bars. Name it 'RotorBarsAlu'. Use the properties as shown and described following.

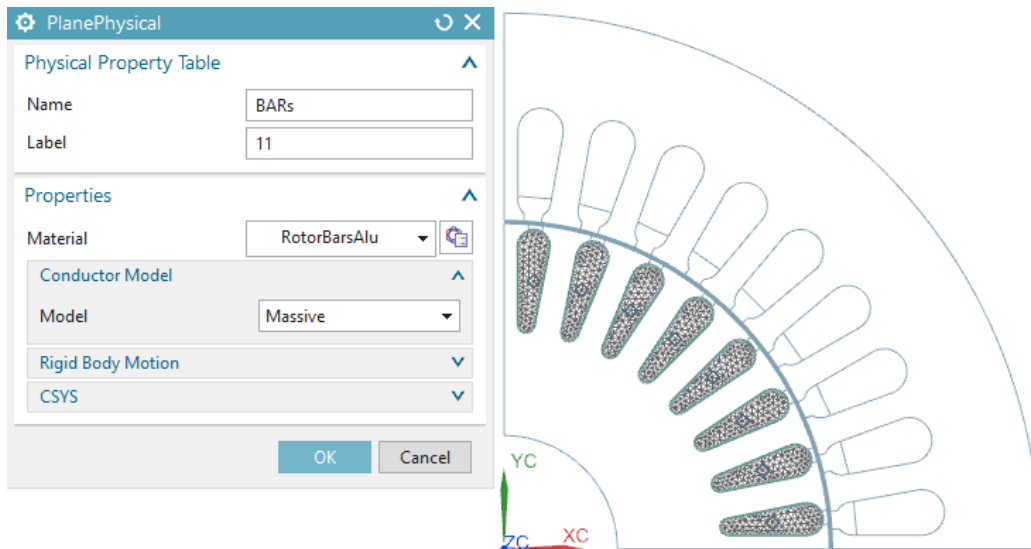

20. Some words about the properties of material Aluminum_Sample1:

- Mass Density (RHO): $7.7e-6$ Kg/mm³.
This property must be given if transient thermal is coupled with the electromagnetic solution.
- Electromagnetics: Relative Permeability (μ_r): 1
With $\mu_r = 1$ the material has the same magnetic characteristic as air.
- Electromagnetics: Electric Conductivity (σ) : 25380710 S/m.
This property is very important for induction effects. The appearance of eddy currents strongly depends on this.
- Thermal/Electrical: Thermal Conductivity (K): 117 W/m K
Basic characteristic for thermal conduction effects. This property must be applied if thermal analysis is coupled with electromagnetics.
- Thermal/Electrical: Specific Heat (CP): 900 J/Kg K
The CP property is responsible for transient thermal effects. It must be applied if any transient thermal is coupled with electromagnetics.

21. The next picture shows the material dialog of Aluminum_Sample1.

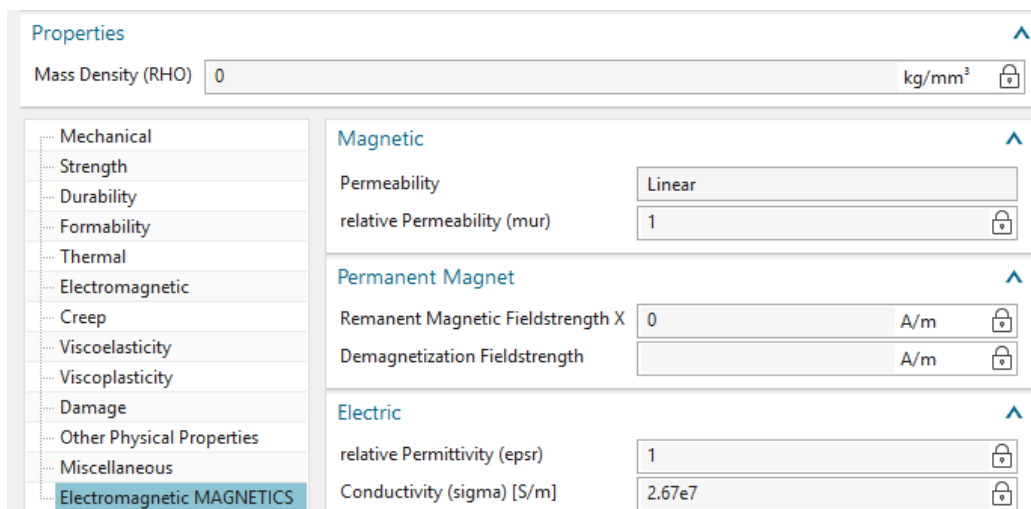

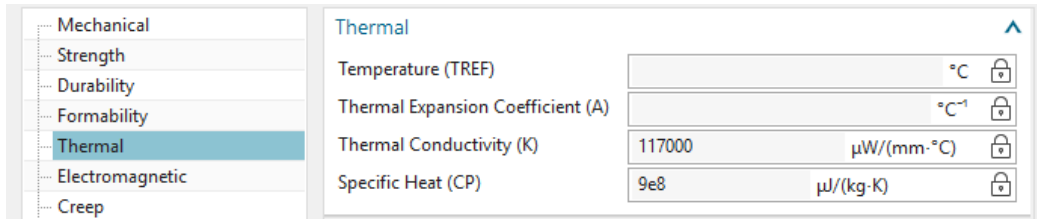

22. Mesh the rotor (1 mm) and use the shown settings. Use the library material 'ElectroSheet_Sample1' from the Magnetics library. Notice the setting of the 'Conductor Model'. The 'Laminated' model simulates the behaviour of eddy currents and the corresponding magnetic field in thin laminated sheets. The larger the value for 'Thickness of one Sheet' the more eddy currents and losses will appear.

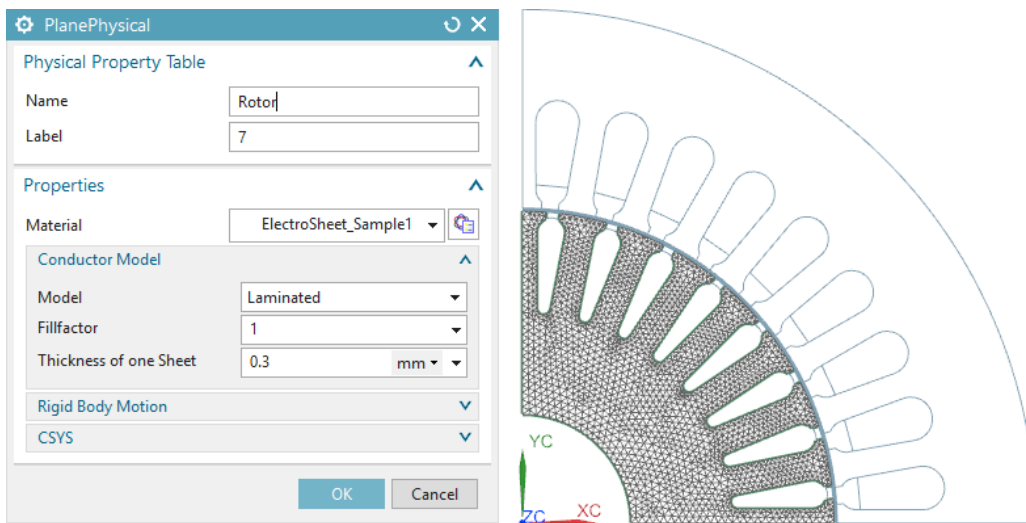

23. Some words about the used material properties in 'ElectroSheet_Sample1':

- Mass Density (RHO): Needed only for transient thermal effects.
- Electromagnetics: Relative Magnetic Permeability (μ_r): 1500
This property is used in case of frequency domain analysis or if there is no BH curve given.
- Electromagnetics: Electric Conductivity (σ): 5800000 S/m
- Electromagnetics: Core Loss Hysteresis Coefficient (K_h): $650 W/m^3$.
This value must be given by measurements or by the material supplier.
- Electromagnetics: Core Loss Eddy Current Coefficient (K_c): $1.2W/m^3$.
This value can be found by test simulations or is also given by the material supplier.
- Thermal: Thermal Conductivity (K): 35 W/m C
- Thermal: Specific Heat (CP): 460 J/Kg K

24. Mesh the stator (2 mm) and use these settings:

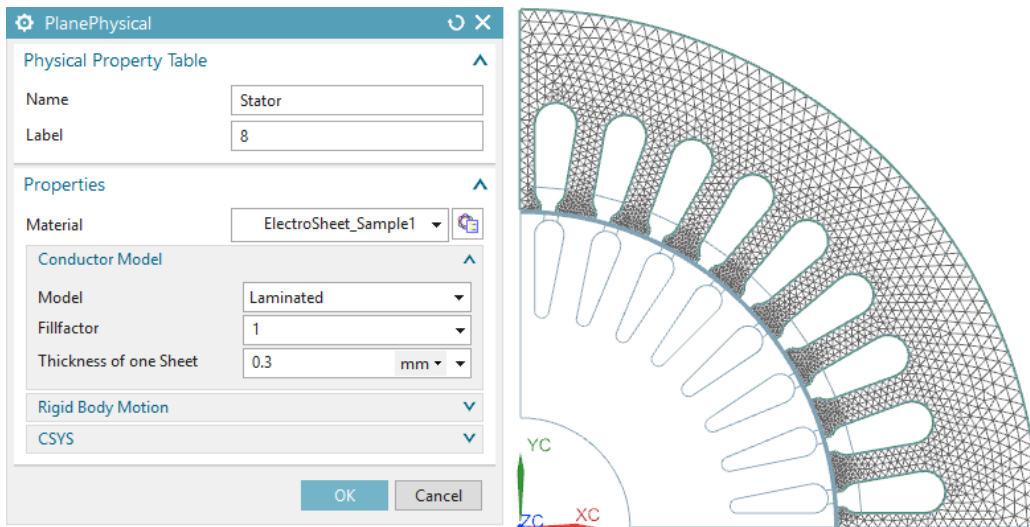

25. All necessary work in the Fem file is done. Switch the displayed part to the Sim file.

6.1.2 Simulation at Fixed Speed

In this section we will use a frequency domain solution to find motor characteristics at one operating point or rotor speed.

1. Create a simulation object 'Enforced Motion 2D Frequency':

- Select the 'Airgap Rotor Edge' and 'Airgap Stator Edge'.
- As a preparation for the following parameter sweep, instead of using a fixed value for the 'Angular Velocity', you may easily create an expression named 'vel' and couple this with the value of 800 rev/min. You do this by simply writing `vel=800` into the 'Angular Velocity' field. Later this expression can be used in a parameter sweep.
- Key in 4 in the field 'Number of Poles Total'.
- Select 'Air' in the material field in box 'Airgap, auto meshed'.

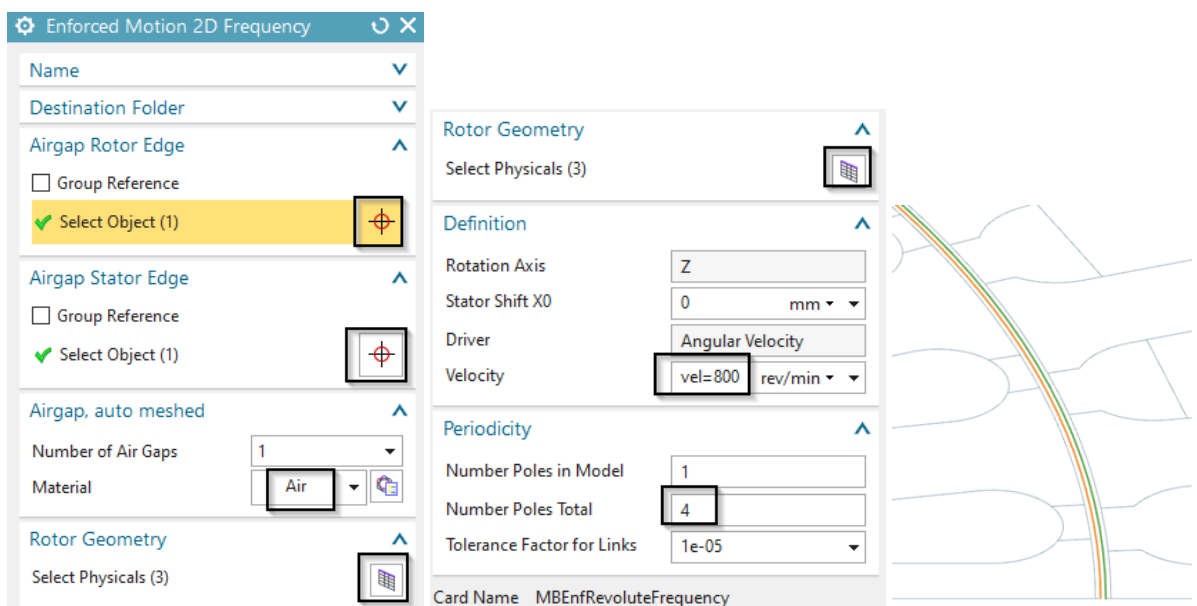

- In 'Rotor Geometry' select the three Rotor Parts, hit the 'Add' button and 'Close'.

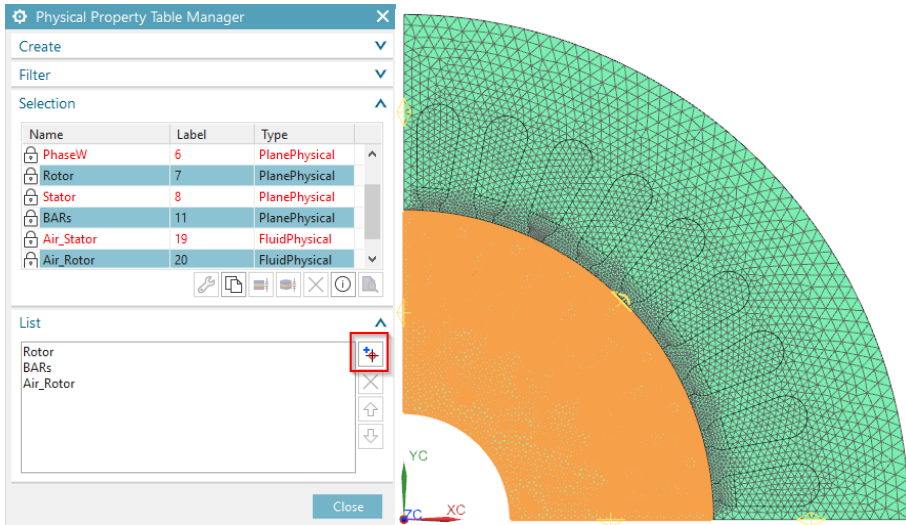

- Click OK and the simulation object is created.

2. Create a constraint of type 'Zero Potential – Flux tangent' on the two boundary faces:

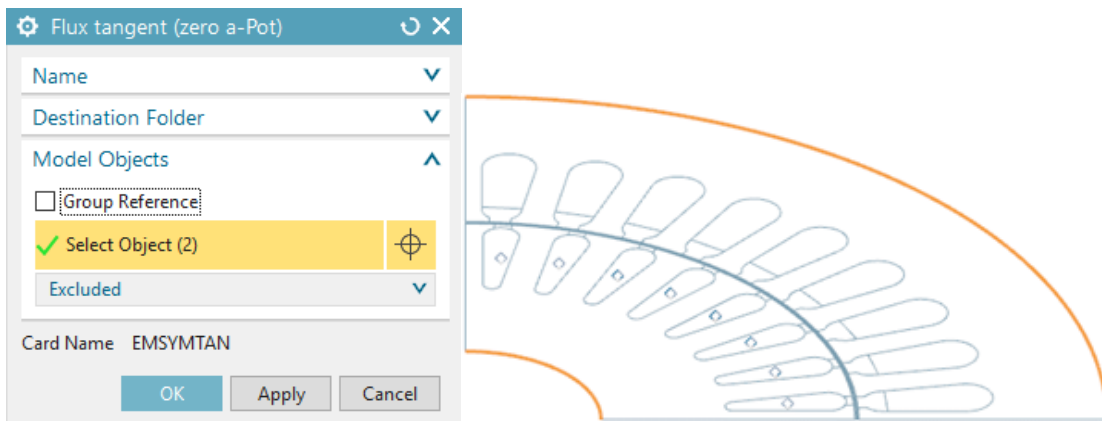

3. For periodicity conditions create two constraints of type 'Link'. The selection should be done in mathematical positive direction, e.g. against the clock sense. So the 'Independent Object' must be the highlighted (orange) edge in the next picture. The 'Dependent Object' will then be the corresponding edge (vertical), rotated about 90 degrees in positive direction. Use the settings as shown. Select also the small edges of the air gap.

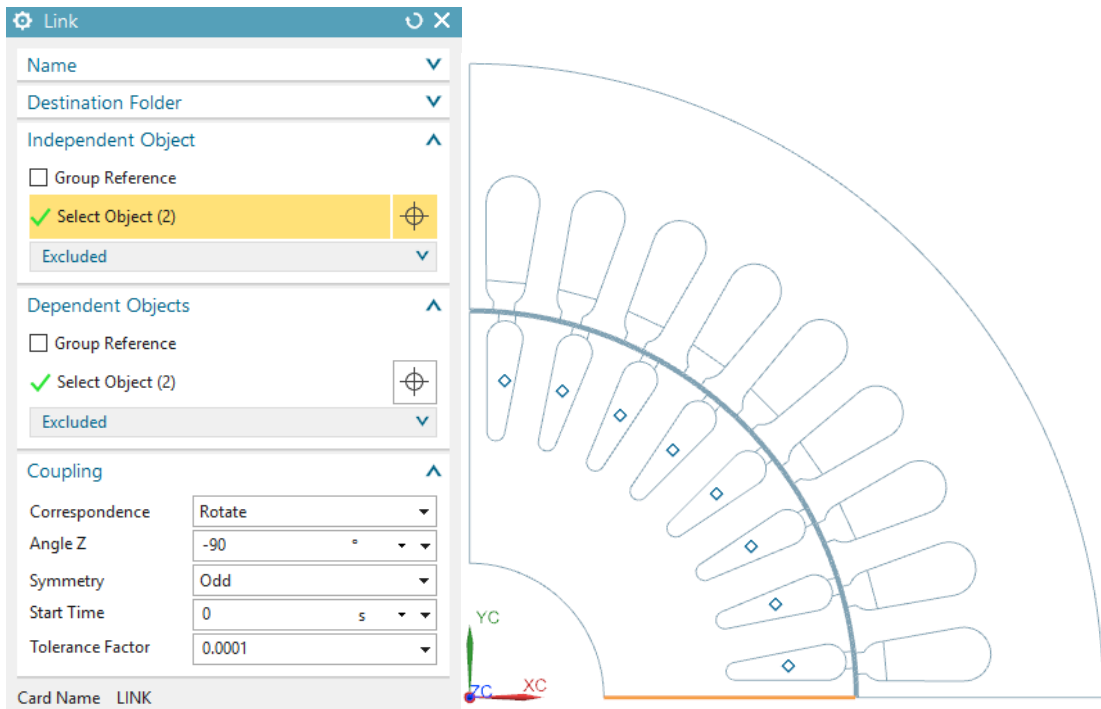

4. Create a second Link constraint for the edges of the stator:

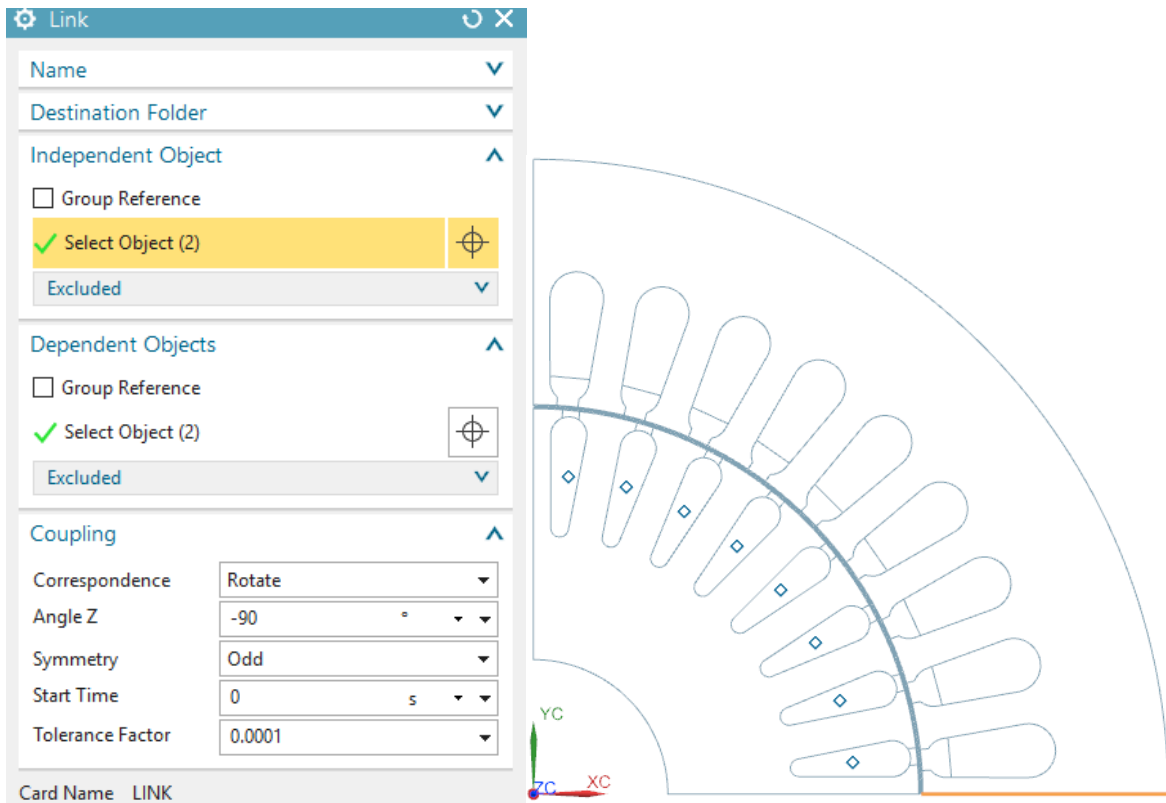

5. Create the following 'Voltage Harmonic 2D' loads: Hint: We apply only 1/4th of the full voltage load because the model contains only 1/4th of the full motor. So the formula we use for the voltage is: $220 \text{ V} * \sqrt{2} / 4$. Here 220 is the effective voltage. Don't forget the phase shifts in the following three dialogs.

- For phase U:

⚙ Voltage Harmonic 2D
🔄 ✕

~ On Physical

Name

Description

Destination Folder

Primary Direction +Z

Type PlanePhysical

Select Physical

Back Direction -Z (optional)

Magnitude

Electric Voltage Amplitude -220*sqrt(2)/4 V

Phase Shift 0 °

Card Name VoltageFreqOnPhysical2D



- For phase V (phase shift -120):

⚙ Voltage Harmonic 2D
🔄 ✕

~ On Physical

Name

Description

Destination Folder

Primary Direction +Z

Type PlanePhysical

Select Physical

Back Direction -Z (optional)

Magnitude

Electric Voltage Amplitude -220*sqrt(2)/4 V

Phase Shift -120 °

Card Name VoltageFreqOnPhysical2D

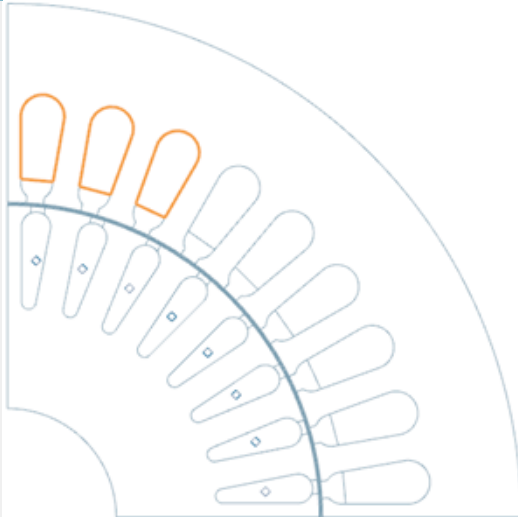

- For phase W (positive value, phase shift -240):

79

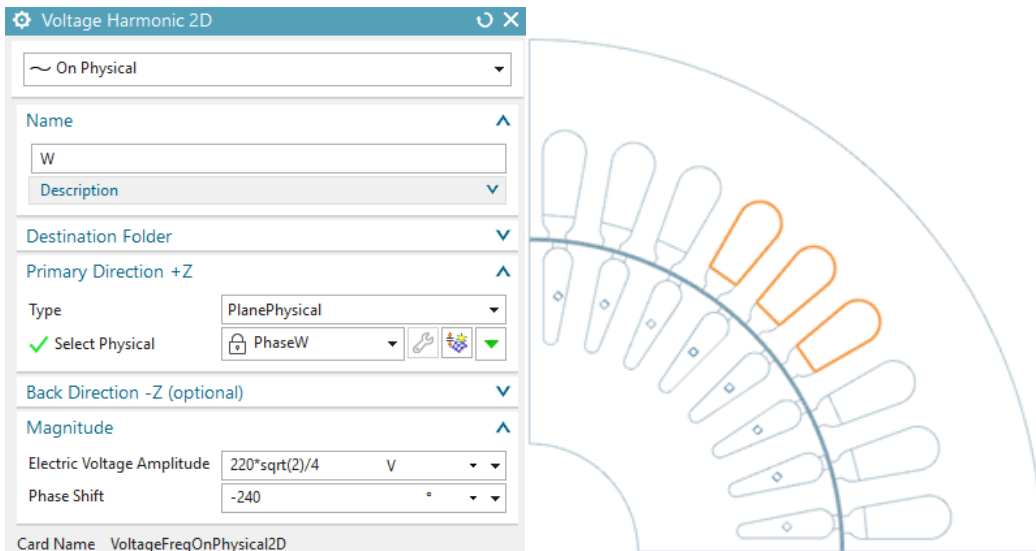

- Create one additional voltage load on the rotor bars. Name this load 'FixedVoltage on free Bars' and apply zero voltage.

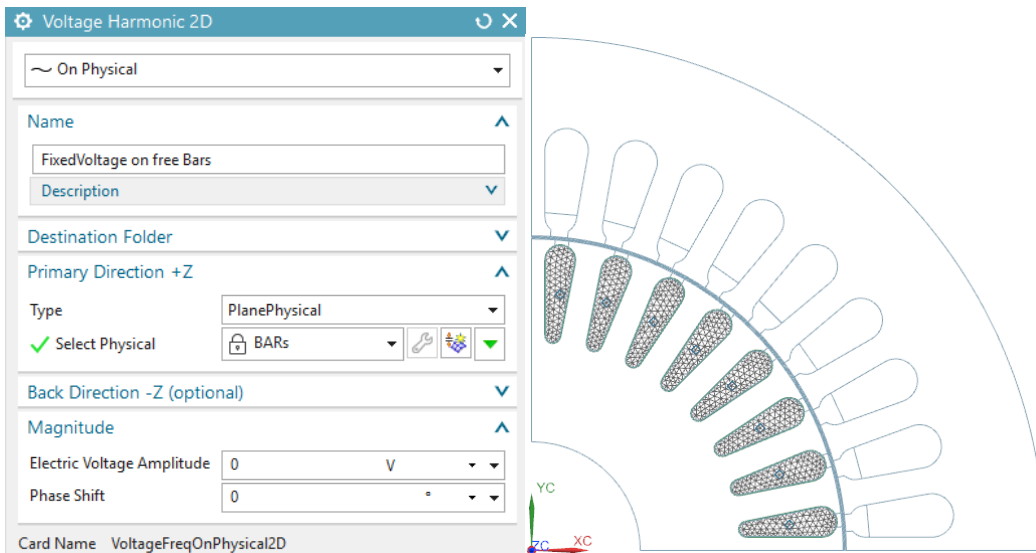

6. Solve the solution.

Hints: In some cases there may appear an error message (see picture) saying that one of the link constraints didn't find its corresponding nodes. This message tells you that there are different numbers of nodes on both edges. You can fix this problem by adjusting (probably one element more or one less) the mesh control on one of the edges.

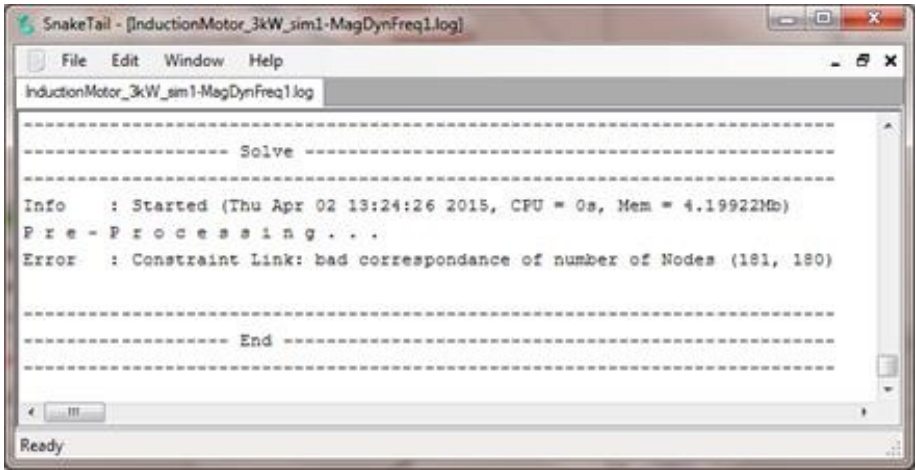

7. The solution will give the result for an operating point with 800 rev/min. To find results for other velocities change the velocity in the motion joint and solve again or run a parameter sweep as shown in the next section 'Sweep over Rotor Speed'.

- The resulting torque is 103 Nm. It can be found in the Post Processing Navigator at 'Graphs', see picture below.

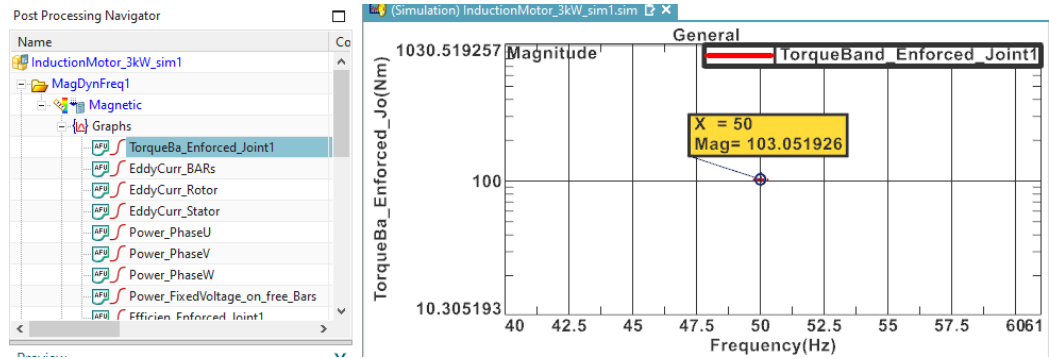

- Magnetic Flux Density (also called 'Induction'): Use the 'Set Result' button to choose between Amplitude, Phase or Real and Imaginary part.
- Hints to complex results: Because this is a frequency domain solution, all loads and results are assumed to be harmonic. Therefore all results are complex, described by real and imaginary parts. Amplitude results (the geometric addition of real and imaginary part) represent the peak values of such harmonics. Other interesting results can also be extracted from the complex results.

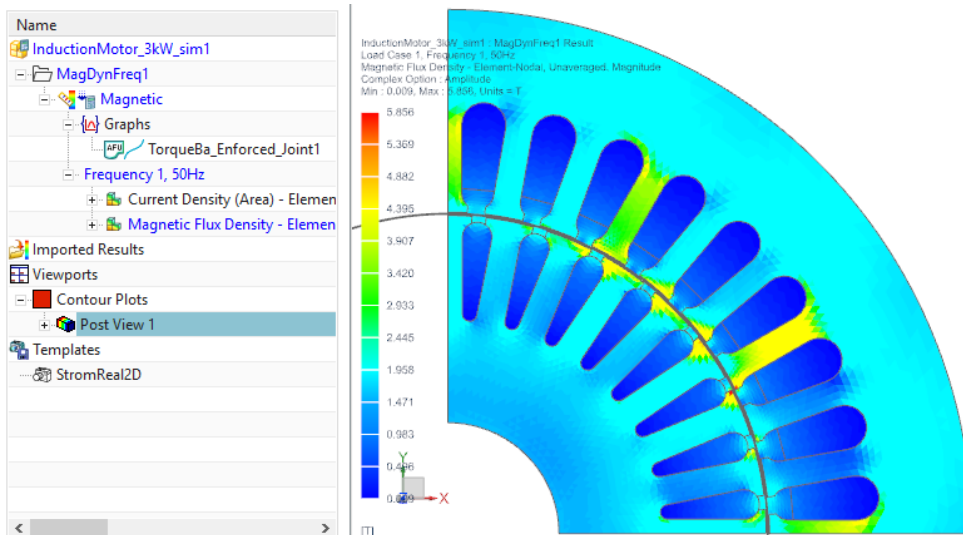

- To study animations over time set the option 'Complex' to 'At Phase Angle' and run the 'Animation'.

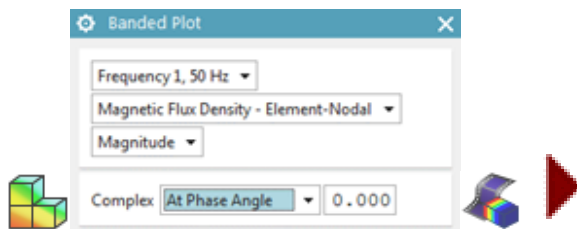

- The Vectorpotential z direction result: (left: Real part, right: Imaginary part). This result shows the magnetic field lines.

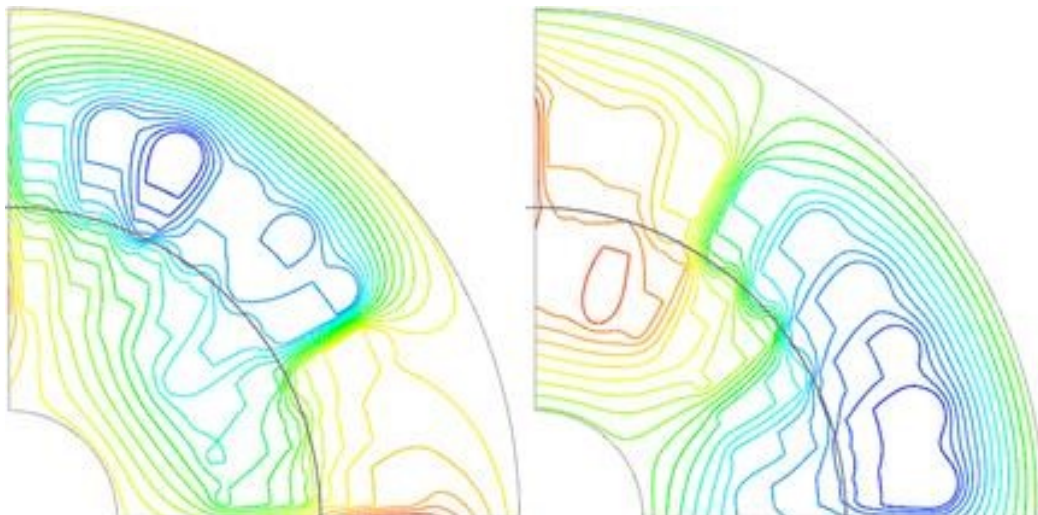

- The Current Density result: (left: Real part, right: Imaginary part)

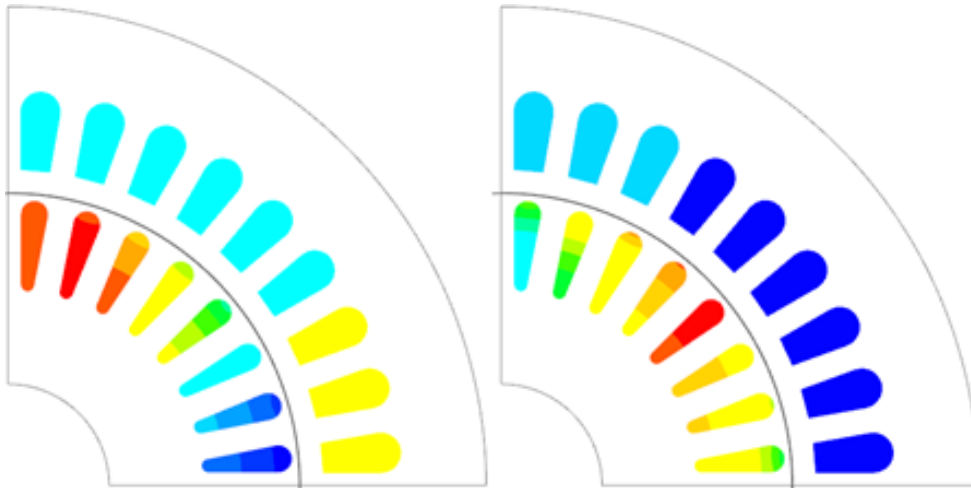

6.1.3 Sweep over Rotor Speed

Now we will use a parameter sweep to step over the whole speed range. By this way we will find the characteristic curves describing the motor.

1. Clone the Solution 'MagDynFreq1' and rename the Clone 'MagDynFreq1_Sweep'. Open the 'Solver Parameters' of solution MagDynFreq1_Sweep and change to register 'Par.Sweep, SolveAgain'.
2. Set the 'Perform' option to 'One Parameter Sweep' and set the settings as shown.

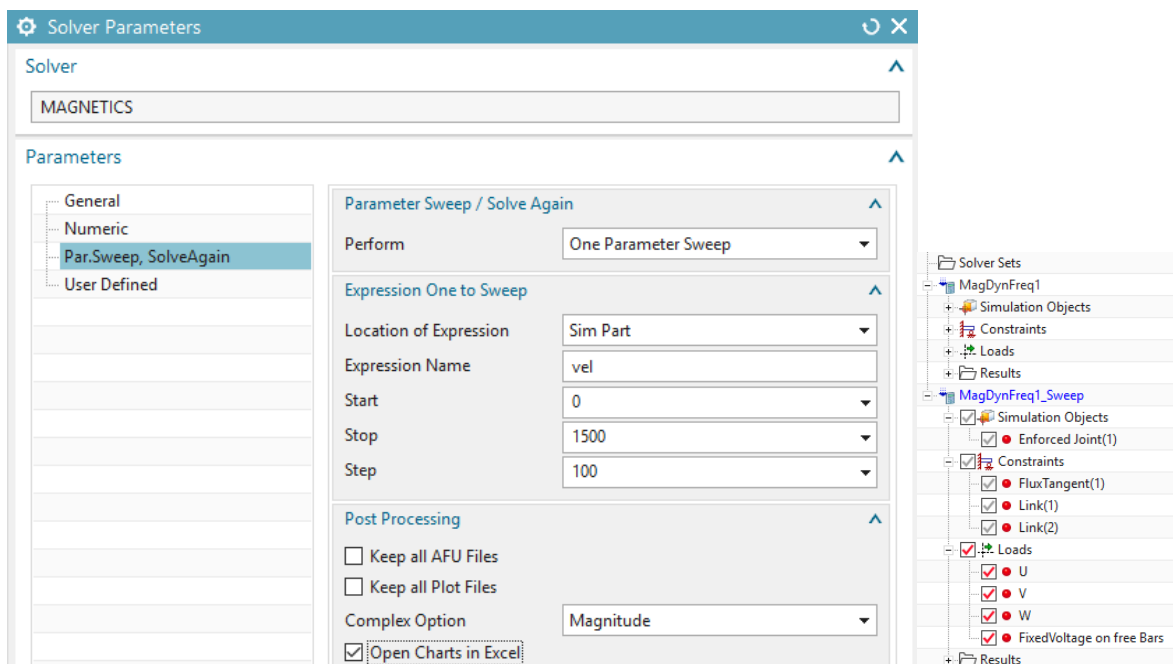

3. Some words about the settings:

- Accept the default 'Location' for the expression: 'Sim Part' because the expression 'vel' resides in the Sim part.
- Expression Name: This must be an existing expression. To check for expressions you can use Tools, Expressions.

- Start, Stop and Step: This defines the sequence of simulation steps.
- 'Complec Option': This setting allows the selection of either 'Magnitude' or the real, im parts of the complex result.
- 'Open Charts in Excel': The parameter sweep results will be written into a vbscript file that can be pushed to MS Excel. Excel must be installed on the computer for that.

4. Solve the solution. Notice the progress bar at the bottom of the NX window. It shows the percentage progress of the steps. Also notice the vbscript (vbs) file in the working folder. It contains all requested tabular results.

- InductionMotor_3kW_fem1.fem
- InductionMotor_3kW_sim1.sim
- InductionMotor_3kW_sim1-MagDynFreq1_Sweep.bun
- InductionMotor_3kW_sim1-MagDynFreq1_Sweep.Efficiency.txt
- InductionMotor_3kW_sim1-MagDynFreq1_Sweep.log
- InductionMotor_3kW_sim1-MagDynFreq1_Sweep.msh
- InductionMotor_3kW_sim1-MagDynFreq1_Sweep.PhaseShift.txt
- InductionMotor_3kW_sim1-MagDynFreq1_Sweep.pro
- InductionMotor_3kW_sim1-MagDynFreq1_Sweep.Torque1.txt
- InductionMotor_3kW_sim1-MagDynFreq1_Sweep.vbs

5. After solve has finished Excel starts and shows the requested results as curves over the given parameter.

- Torque and Efficiency over speed:

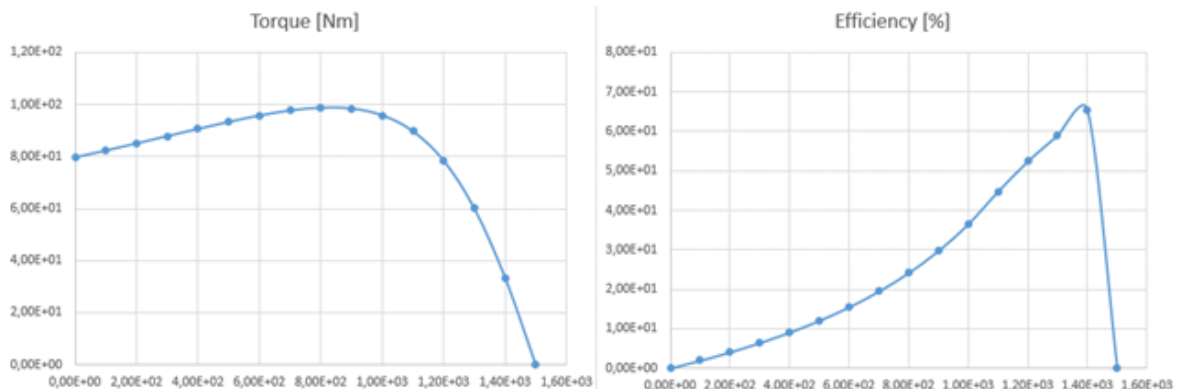

- Input Power and Phase Shift (Power Factor) over speed:

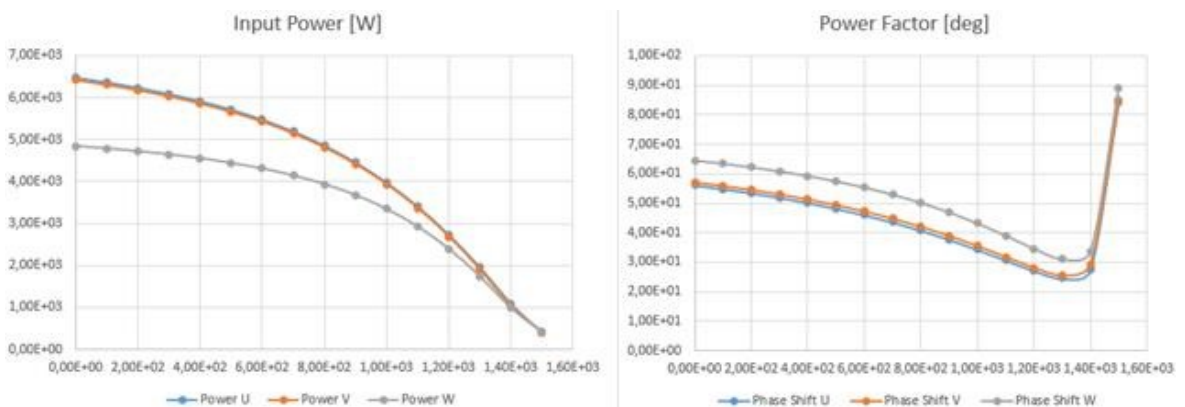

- Current and Hysteresis Loss over speed. Be aware that the computed hysteresis loss in frequency domain is not very accurate, because only one frequency is taken into consideration. The later time domain analysis will show higher hysteresis losses.

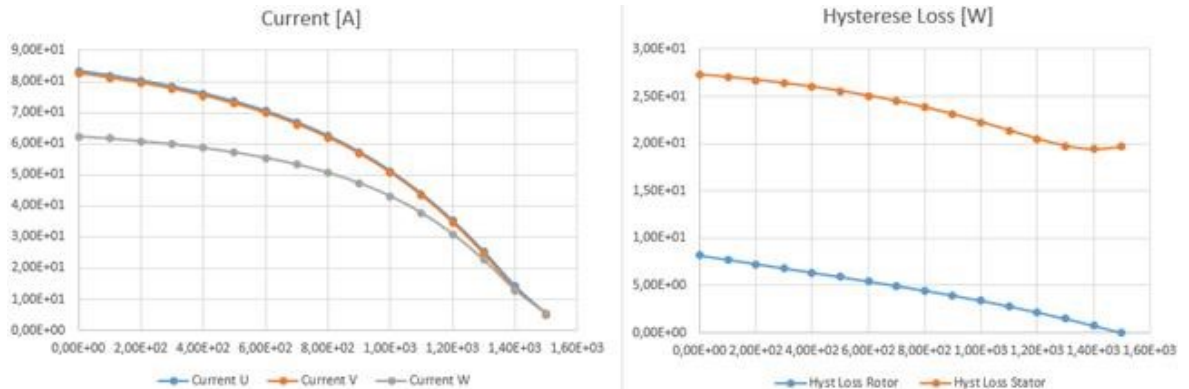

6.1.4 Sweep with two Parameters

In many cases it is of interest sweeping over two parameters. For this motor we want to know for instance how torque and efficiency changes with the speed but also with the electric conductivity of the bars. The result will be shown as a surface graph in excel.

1. Clone the Solution 'MagDynFreq1.Sweep' and rename the Clone 'MagDynFreq1_TwoSweep'. Open the 'Solver Parameters' of solution MagDynFreq1.Sweep and change to register 'Par.Sweep, SolveAgain'.
2. Set the 'Perform' option to 'Two Parameters Sweep' and set the settings as shown. There will be a parameter 'CondScale' in the Fem part. This parameter will scale the conductivity of the bars.

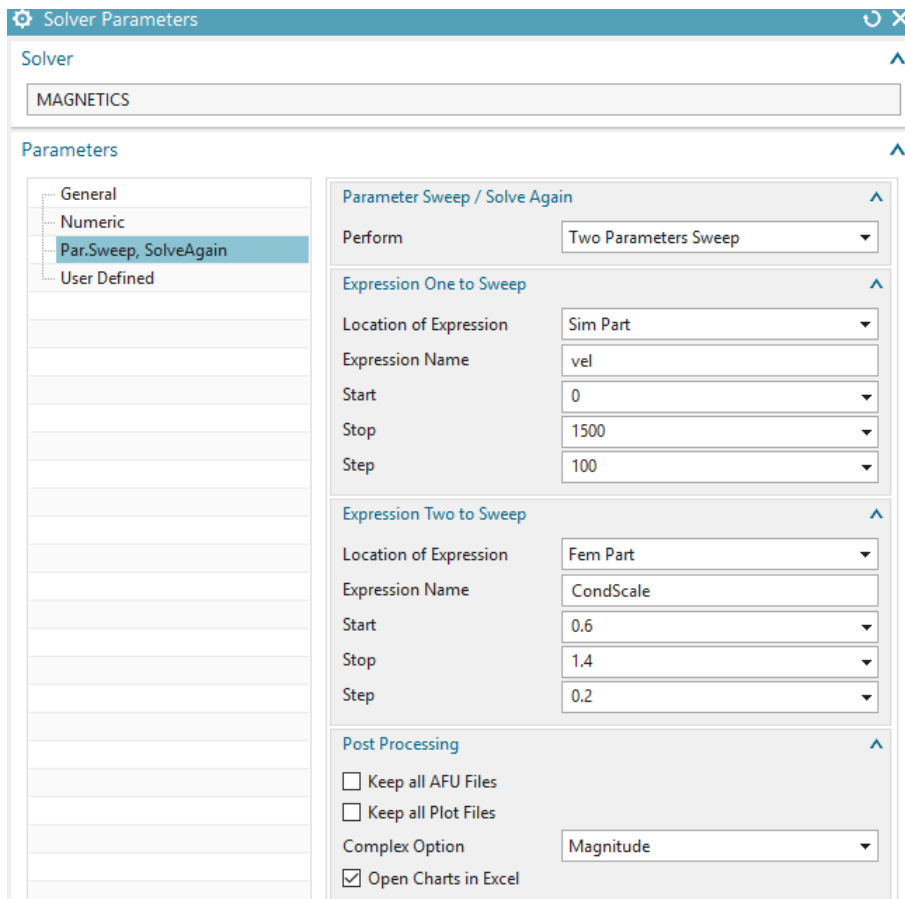

3. Change to the Fem part and create an expression (shortcut Strg+e). Name this 'CondScale' and set it to 'Unitless'.

	Name	Formula	Value	Units	Dimensionality	Type
1	Default Group					
2	CondScale	1	1	Unitless	Number	

4. Edit the material properties of the bars and key in 'CondScale*2.67e7' for the electric conductivity.

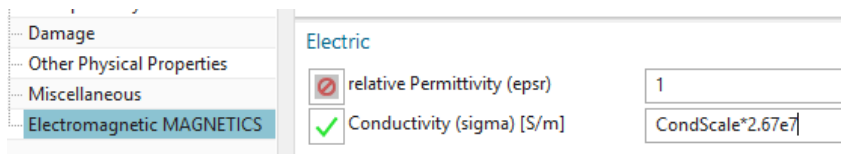

5. Change the displayed part to the Sim file and solve the new solution. The resulting graphs will look as shown below.
6. Torque and Efficiency over speed and bar conductivity:

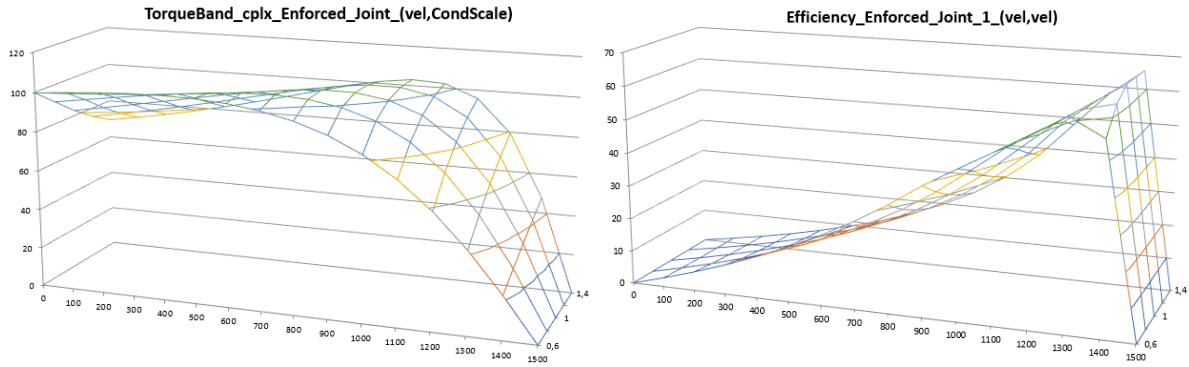

7. Input Power and Phase Shift (Power Factor) over speed and bar conductivity:

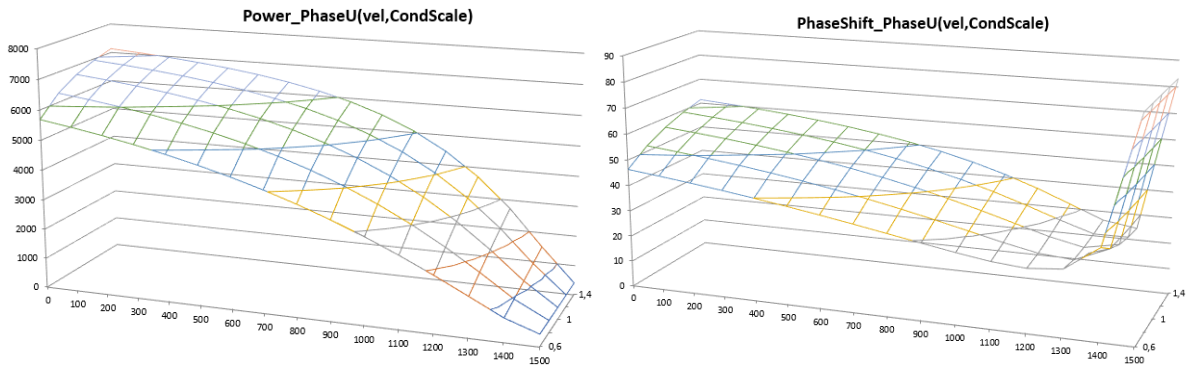

6.1.5 Thermal Analysis

In this section, we will include simple 2D thermal analysis methods for the induction motor. In more detailed simulations this must be done in 3D to capture end effects and the motor housing. In this example, we will directly use the power losses from the electromagnetic analysis as input loads for a thermal solve. We include the effects of thermal conduction in all parts. Also, we include thermal convection effects with given fixed coefficients to model water cooling. The air gap is modeled as a thermal conductive area, so heat produced in the rotor can travel through the air gap into the stator. To capture the effect of cooling by a fan we add additional convection to the air gap.

In this case we use a set of given convection coefficients. Of course, these values strongly influence the thermal results of the simulation. To find realistic values for convection coefficients simulations should be calibrated with experiments. Another way to find values is through analytical considerations by use of convection formulas that model shear flow between two moving plates. Such formulas can be found in standard literature like 'VDI Wärmeatlas'.

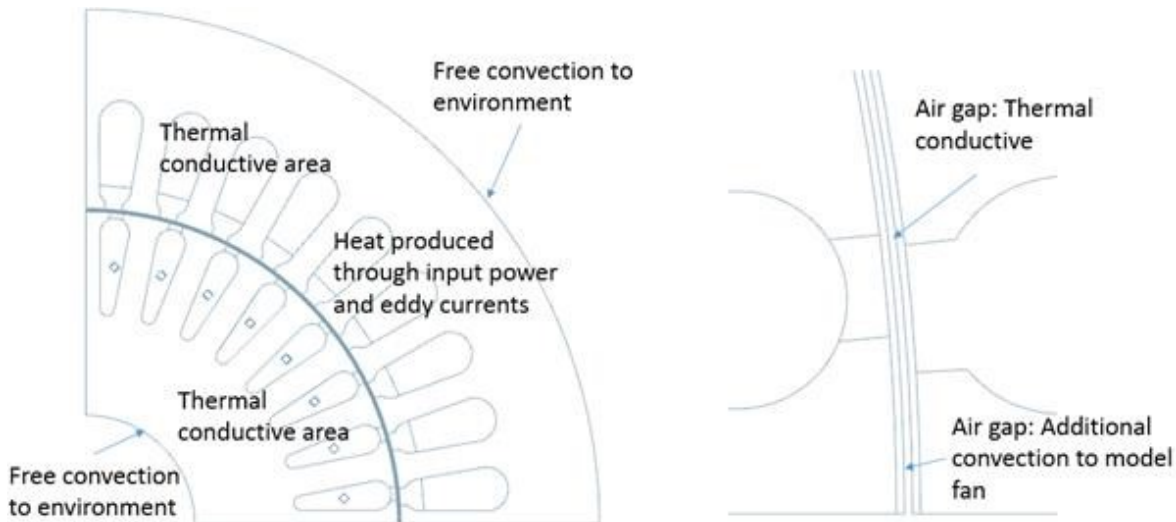

We first run an analysis at one operating point and afterwards a sweep over the full range. We choose a speed of 1400 rev/min because of its best efficiency as we have found in the previous section. Since the material properties already have all information for this thermal analysis we can continue with solution settings. Remember the necessary material data that is needed for this is only Thermal Conductivity (K). In case of transient analysis the Thermal Capacity (CP) would be needed.

1. Clone the solution MagDynFreq1_Sweep and rename it to MagDynFreq1_Thermal_Sweep.
2. First switch off the parameter sweep (in 'Solver Parameters'). We will activate it later.
3. Edit the expression vel and set it to 1400 rev/min (Tools, Expressions ...).
4. Edit the solution and change to register Coupled Thermal.
 - Change the Thermal Solution to Steady State. This will compute the settled thermal situation while running at the given operating point.
 - Activate the Output Requests as shown.

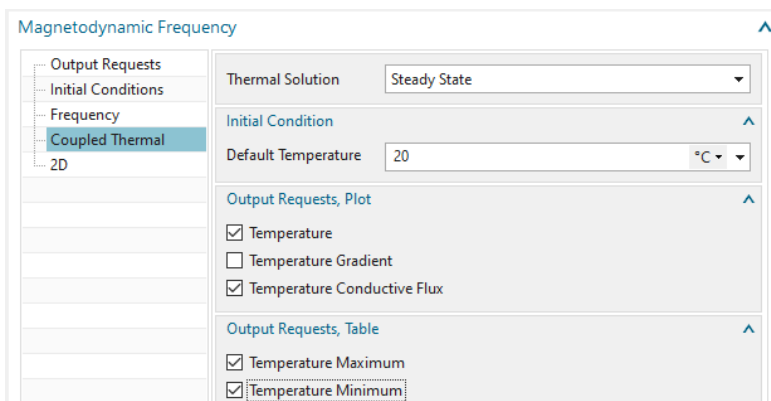

5. We want to model the effect of a water cooled outside stator face.
 - Create a constraint of type 'EM Thermal Constraints' and set the Type to 'Free Convection'.
 - Select outside edge.

- Key in the values as shown below. Notice the unit of the convection coefficient: $W/m^2 C$.

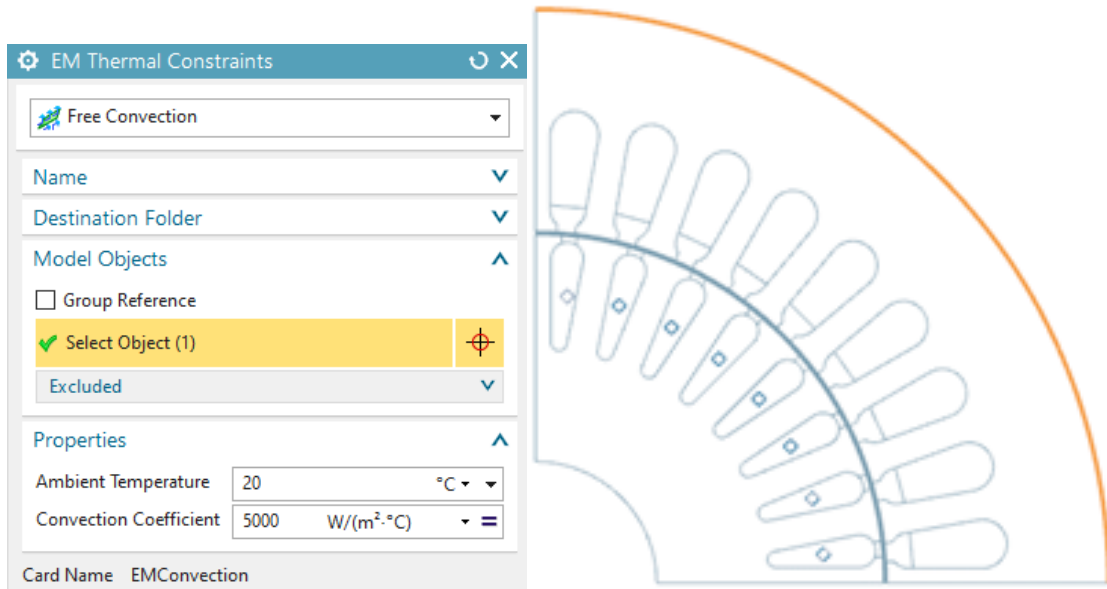

6. Similar we model a cooling inside the rotor with smaller coefficient.

- Create a constraint of type EM Thermal Constraints and set the Type to Free Convection.
- Select inside edge.
- Key in the values as shown below

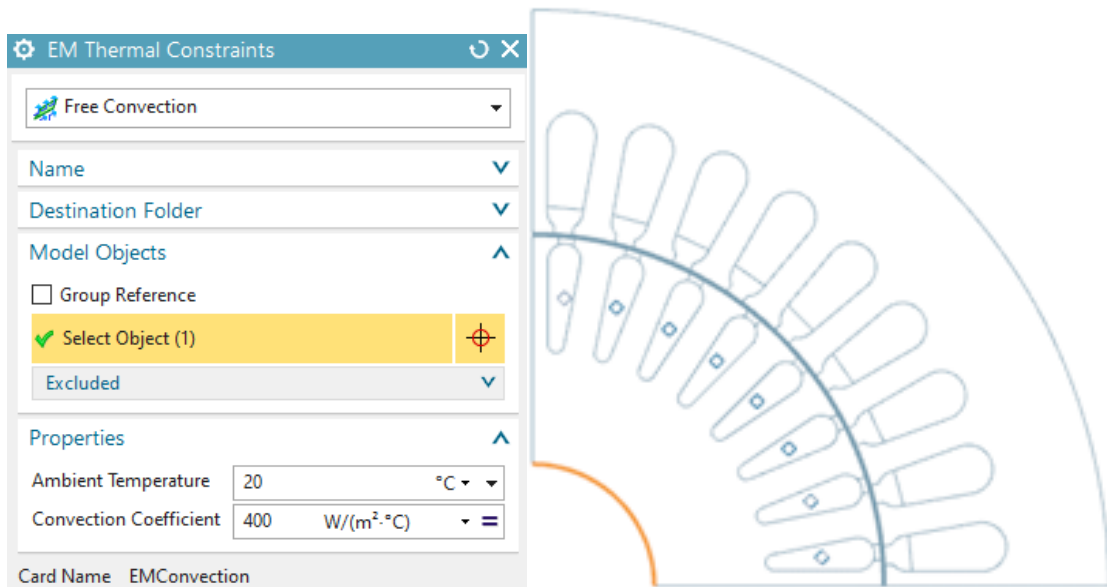

7. Next create a Free Convection constraint on the rotor edges. This will simulate the effect of cooling air from a fan flowing through the air gap.

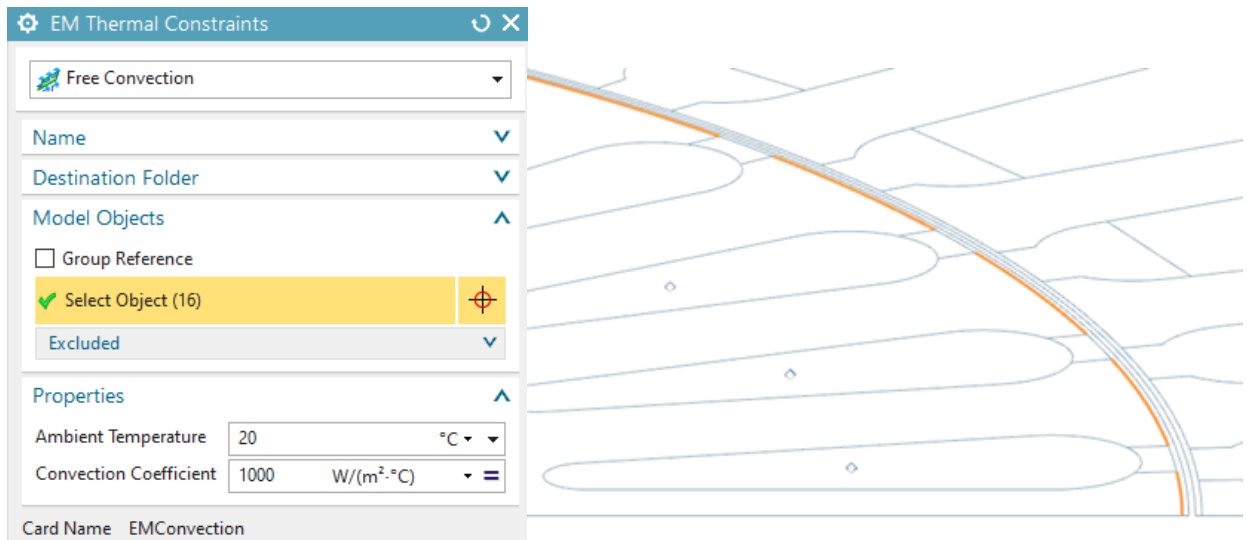

8. Switch off the parameter sweep (if not already done) and solve the solution.
9. The resulting temperature field at 1400 rev/min has a maximum value of 270 C as shown in the next picture (left side). On the right side, there is the thermal conductive flux displayed with vectors. The thermal flux result helps understanding how the thermal energy is produced and how it moves.

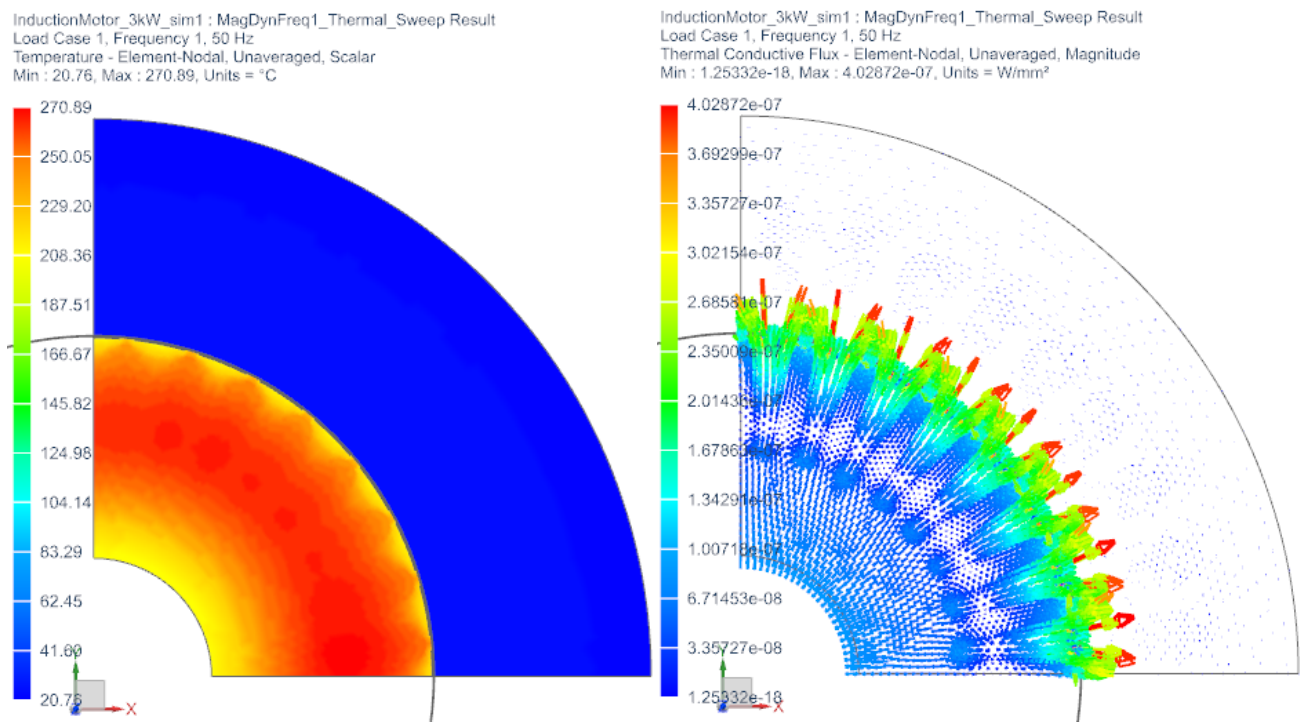

10. Activate the one parameter sweep. Because in this software version the thermal sweep results are not written to the excel file we must view them in text file. Therefore we set the solver parameter 'Result Tables (txt)' to 'Append'. Solve the solution. After finish there appear two additional results (maximum and minimum temperature) as text files.

Line	TempMax__Unit_C: ThermalRegion: 0	Value
1	TempMax__Unit_C: ThermalRegion: 0	439.8023940652081
2	TempMax__Unit_C: ThermalRegion: 0	455.8457067658979
3	TempMax__Unit_C: ThermalRegion: 0	473.4293889484283
4	TempMax__Unit_C: ThermalRegion: 0	492.6128765987489
5	TempMax__Unit_C: ThermalRegion: 0	513.3756689640212
6	TempMax__Unit_C: ThermalRegion: 0	535.5532495316708
7	TempMax__Unit_C: ThermalRegion: 0	558.6757263245247
8	TempMax__Unit_C: ThermalRegion: 0	581.7901774075916
9	TempMax__Unit_C: ThermalRegion: 0	603.0779086201599
10	TempMax__Unit_C: ThermalRegion: 0	619.2456065884987
11	TempMax__Unit_C: ThermalRegion: 0	624.5251846792693
12	TempMax__Unit_C: ThermalRegion: 0	609.2750884987115
13	TempMax__Unit_C: ThermalRegion: 0	558.4672222399635
14	TempMax__Unit_C: ThermalRegion: 0	451.8323471079671
15	TempMax__Unit_C: ThermalRegion: 0	270.8942707537752
16	TempMax__Unit_C: ThermalRegion: 0	20.22403008602081
17		

- In an excel graph this gives the information about how temperature behaves over the speed range:

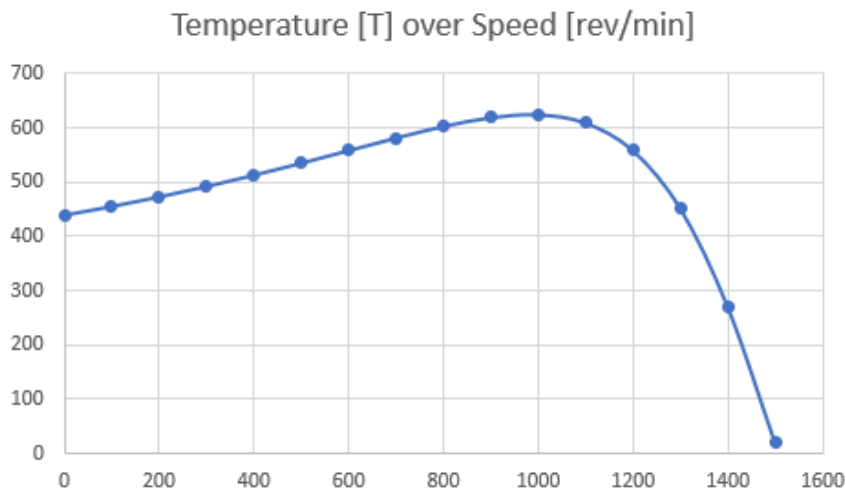

6.1.6 Transient Run at Fixed Operating Point

Now we do a precise solve for the detailed computation of losses. Because of the transient solution it is possible also to accurately compute a nonlinear BH curve. Because of simplicity reasons we don't use nonlinear material for this and we also don't analyse for temperature. We choose 1400 rev/min as operating point.

- Create a new solution of type 2D Magnetodynamic, Transient. Rename the solution 'Mag-DynTime1_Speed1400'.
- Set the Output Requests as shown.

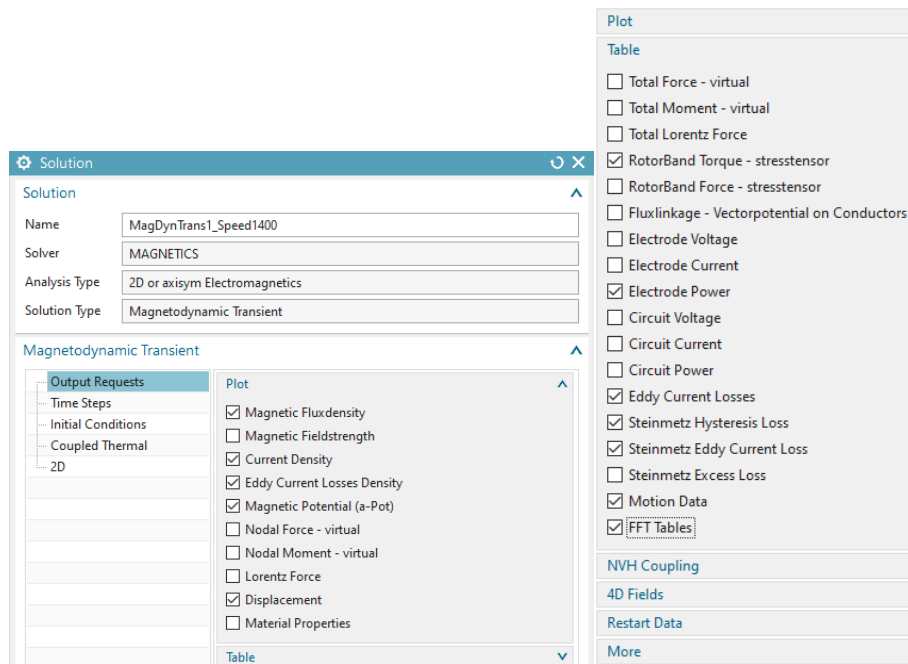

3. Some words to table results:

- Motion Data: This option writes out the displacement step and total displacement of the motion joint at each time step. That is quite important, because it allows creating graphs over the rotation angle.
- FFT Tables: This option enables the fourier transformation of the active table results. In box More there are some options about the fourier transformation process but the defaults are good for now.

4. In register Time Steps:

- Set the Time Increment to 0.000119048 sec. With a rotor speed of 1400 rev/min this corresponds to 1 degree per time step.
- Set the Number of Time Steps to 1800. This corresponds to 5 times 360. So we will analyze 5 rotor turns. This should be enough to decay the transient that we expect due to sudden start.

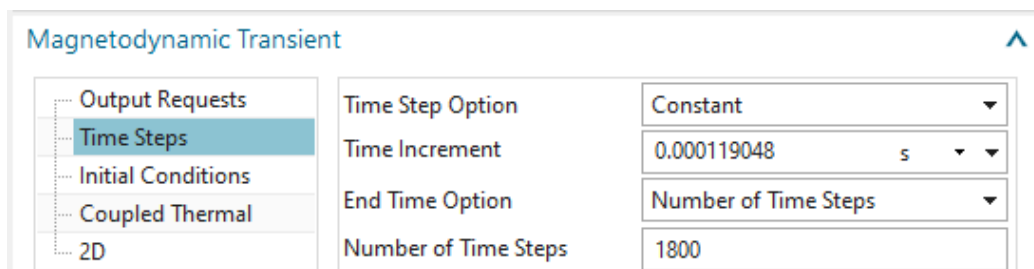

5. In register 'Initial Conditions': Set the 'Magnetic' option to 'Zero Vector Potential'. This is the best starting condition for this voltage driven system.

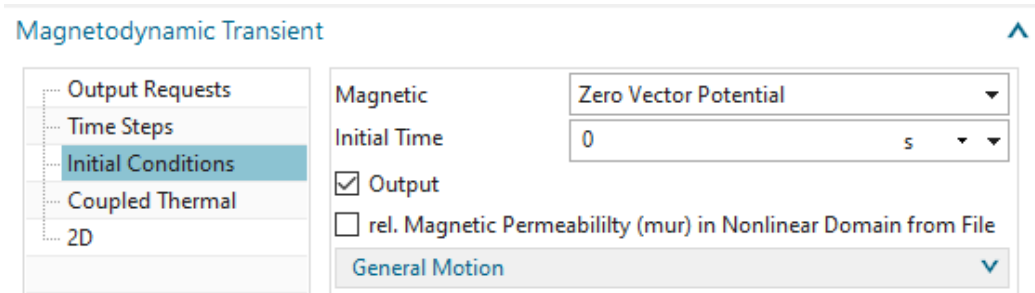

6. In register 'Coupled Thermal': Use the default option None. Because this simulation will cover only a short time period there are no meaningful thermal results expected.

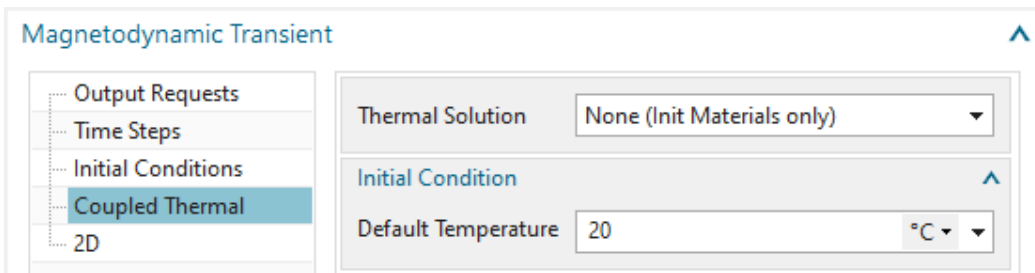

7. In register '2D': Key in the thickness.

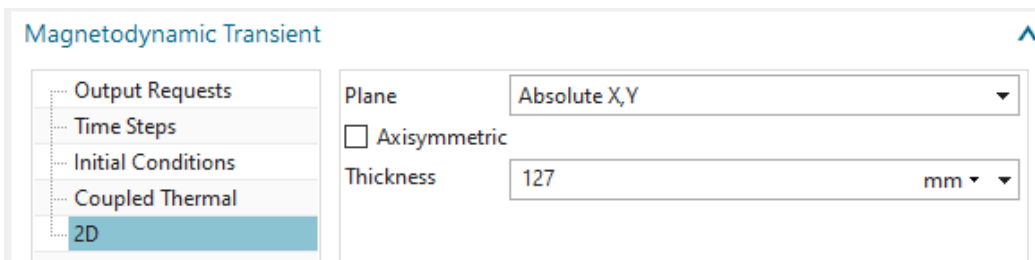

8. Drag all but the thermal constraints into the new solution. You can simply reuse the existing ones.

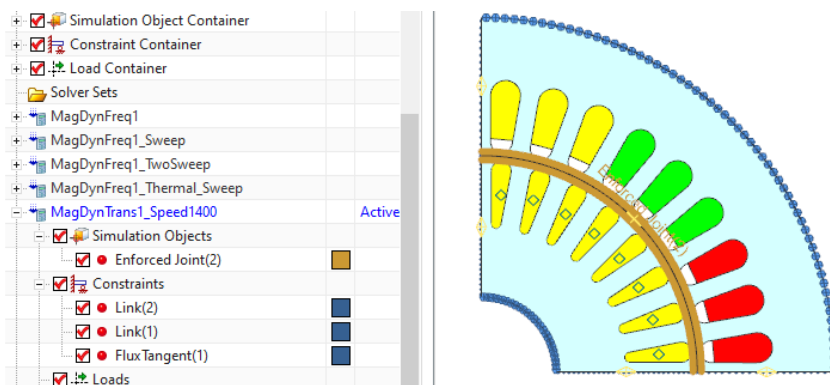

9. The loads must be created newly because they are different from the frequency solution loads. Create 3 new loads on the corresponding coil faces. Use type 'Voltage 2D', Type 'on Physical' with Method 'Harmonic'. Take care of the correct signs of the values (see picture below).

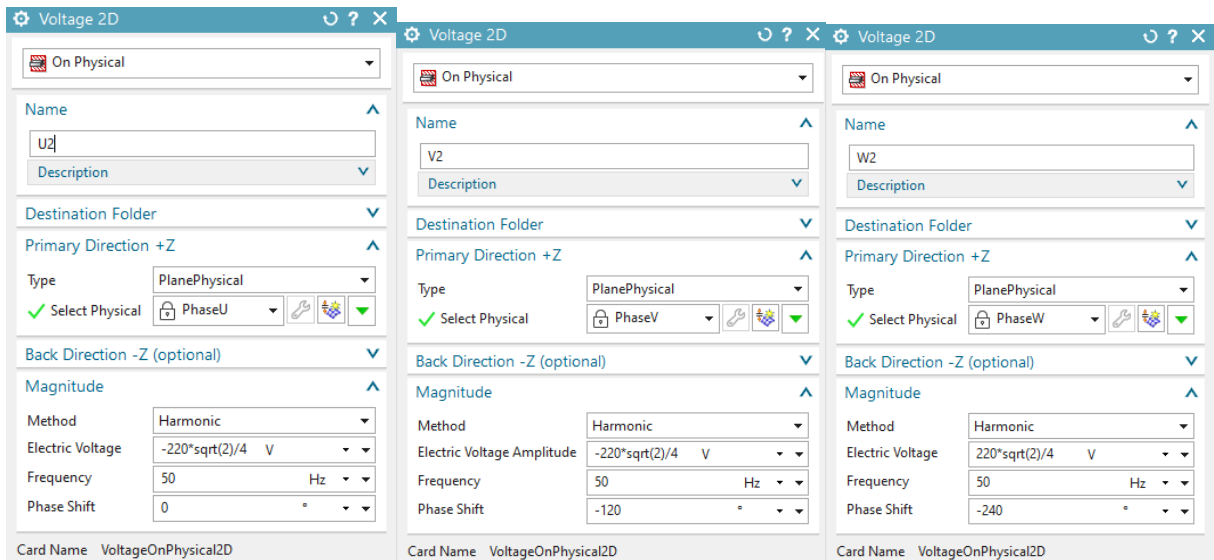

10. Also the load with zero voltage on the Bars must be newly created.

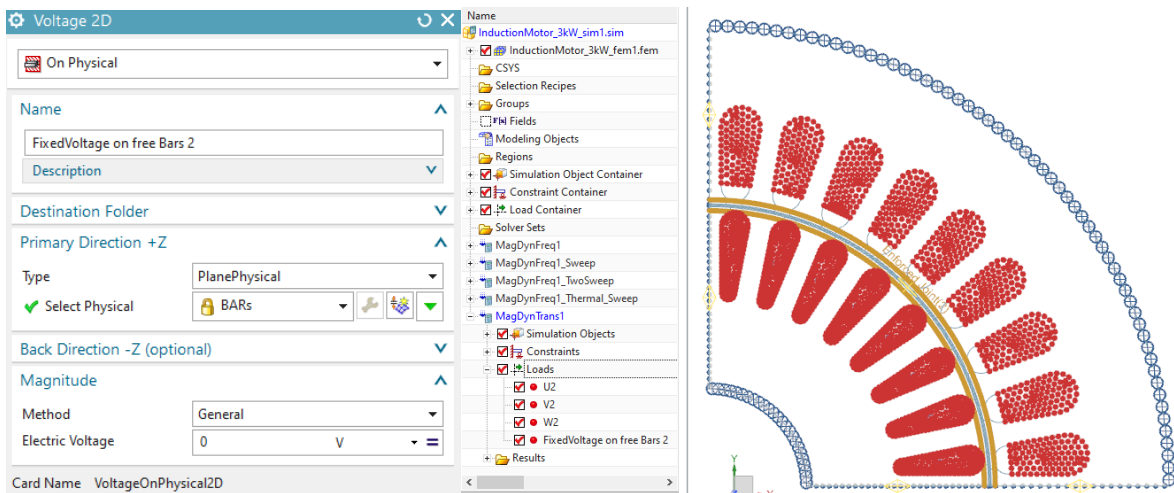

11. Create a 'Simulation Object' of type 'Enforced Motion 2D'. Accept the default type 'Revolute by Moving Band'.

- Select the Rotor and Stator Edges,
- At 'Airgap, auto meshed', choose 'Air',
- For 'Rotor Geometry', select the physicals Rotor, BARs, AirRotor.
- Set the 'Driver' to 'Angular Velocity',
- Key in 'Velocity', 'Number of Poles total' (see picture below).
- Click OK to finish the dialogue.

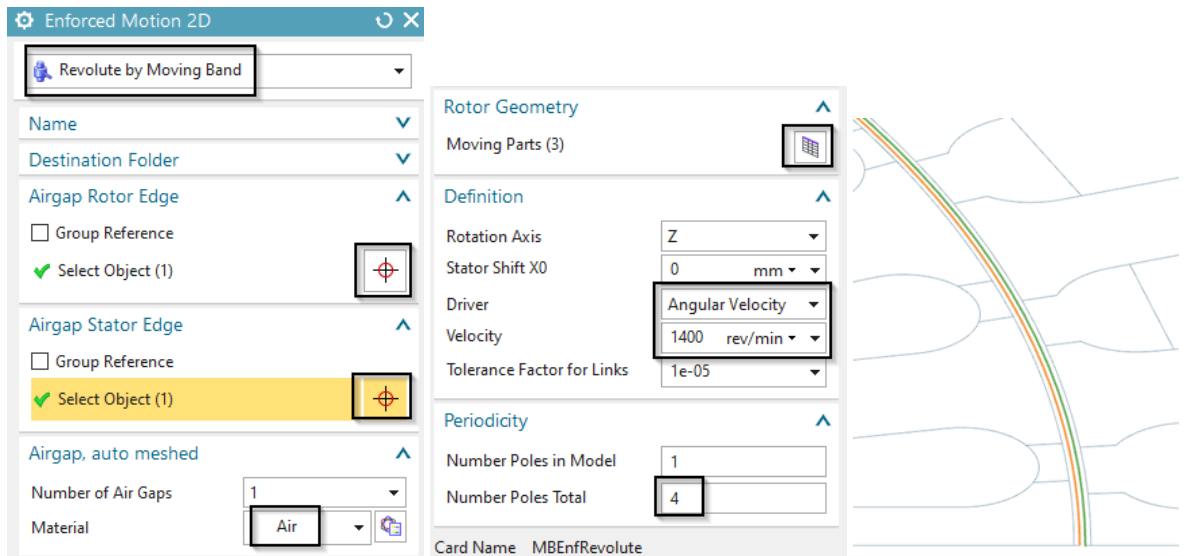

12. Solve the solution. Because of the number of steps the solve process will take about 10 - 15 minutes.
13. After the solution has finished check the tabular results.
 - Hint: By default the AFU graphs show time on the abscissa. Instead you can set the rotor angle (or any other result) to the abscissa using the following method: Select in the XY Navigator two curves, Torque and TotalDispl. Then choose RMB Two Function and choose the second from the two possibilities (see picture).

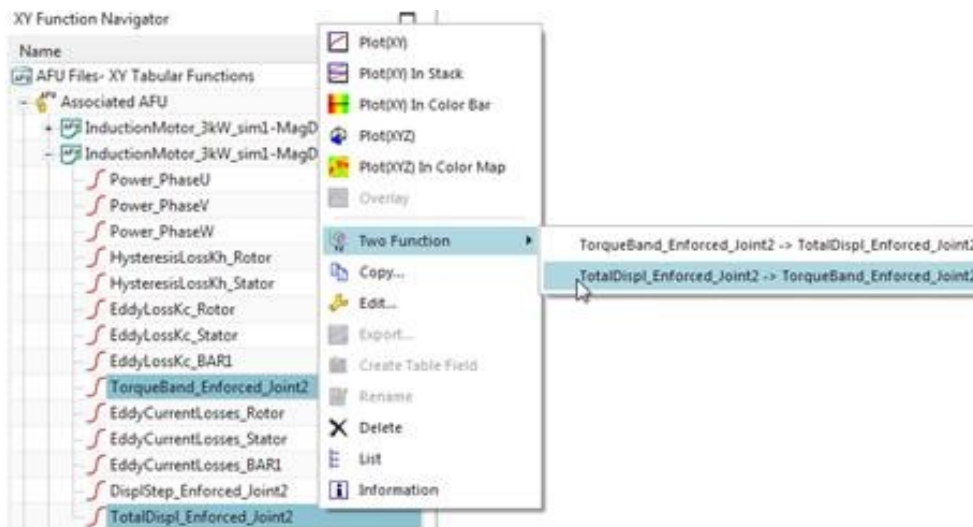

- The Torque result shows transient behaviour at the beginning and becomes more and more stationary after time.

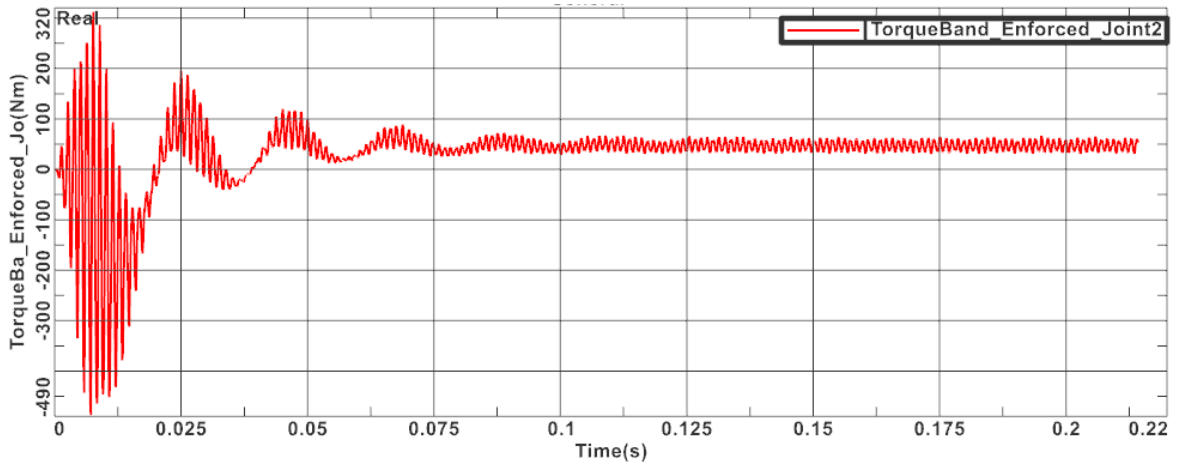

- Let's compare this to the torque we found with the prior frequency domain analysis: There we had 47.7 Nm at 1400 rev/min. Here, if we cut the transient as in picture below, there appears an oscillation between about 30 and 60 Nm with RMS 48 Nm. So, both time and frequency results are very near. The time domain analysis is more precise and additionally it captures torque ripple information.

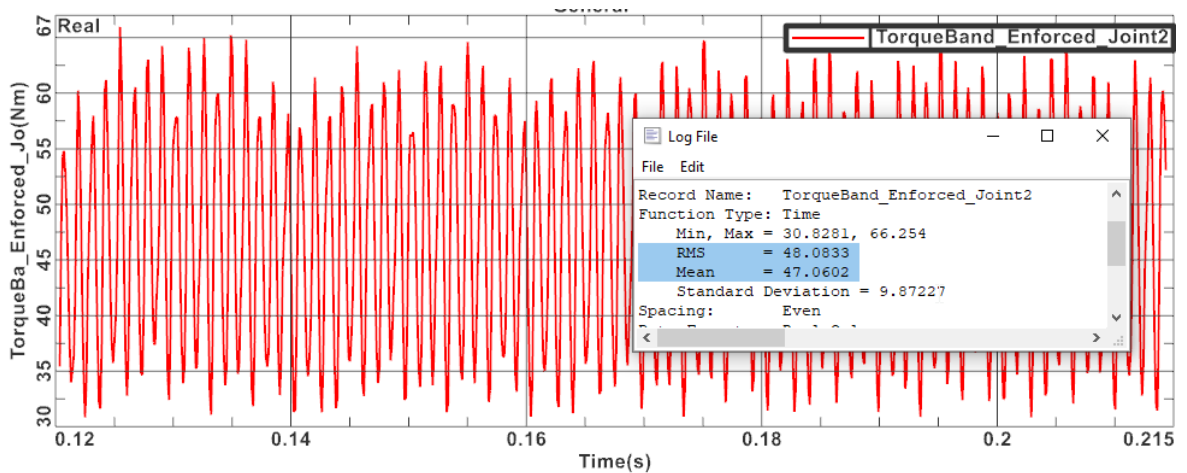

- The Eddy Current losses on bars, rotor and stator also shows the transient, mainly on the bars. Other results, like power on the three phases are also available.

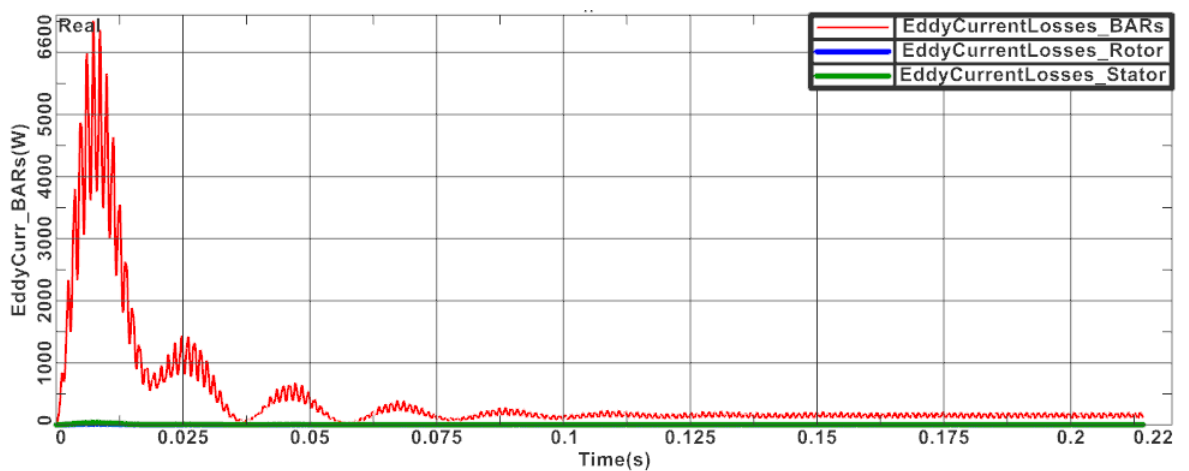

- The Hysteresis Losses on Rotor and Stator are computed after all time steps have finished. This additional post processing step can consume much time. For the com-

putation Fourier transformations are performed at each element to find dominant frequencies and amplitudes. By default the system computes 15 frequencies. Let's compare again these values to those from the frequency domain analysis: in time domain, we find 77 watt on the stator and 5.6 watt on the rotor. The frequency analysis showed much smaller values and is less precise, because it takes into account only the first, dominant frequency.

```

InductionMotor_3kW_sim1-MagDynTrans1_Speed1400.HystLossKh.txt
1 HysteresisLossKh_Unit_W: Rotor: 5.633220708178191 Stator: 77.3782574594274 BARs: 0.2230170578517194
2

```

6.1.7 Start of Motor

It is also of interest to analyse the transient start behaviour of an induction motor. To do so we have already applied nearly all information. Two things are missing: The mass inertia property of the rotor and a dynamic joint instead of the enforced one.

1. Change to the Fem part and edit the physical properties of the rotor. Key in the value 1500 Kg mm² for Inertia RZ. This value can be found by running the CAD function Analysis, Measure Body  using the detailed CAD geometry and mass density information applied to the rotor.

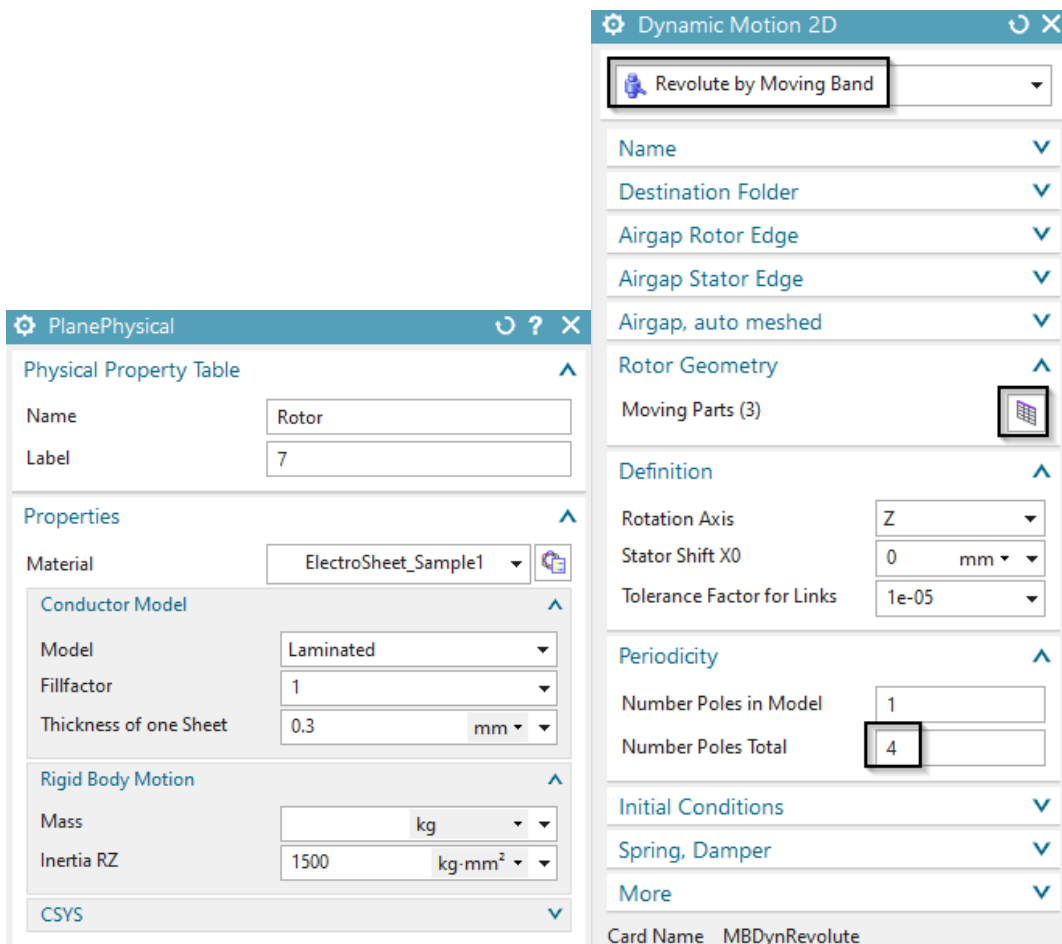

2. Change to the Sim file again and

3. Clone the solution 'MagDynTime1' and rename the new one to 'MagDynTime2_MotorStart'.
4. Remove the Simulation Object 'Enforced Joint' from the new solution.
5. Create a new Simulation object of Type 'Dynamic Motion 2D' (see picture above right). Select Rotor and Stator Edge, key in 'Number of Poles' and 'Rotor Geometry' same way as before.
6. Modify the voltage load to 50 percent.
7. Solve the solution. Again it takes 10 – 15 minutes.
8. After solving you can display the following graphs:

- Total angular displacement (red curve) and Velocity (blue curve) over time (set the units to rev and rev/min). It can be seen that after the transient there appears still oscillation but the velocity reaches more and more the synchronous value of 1500 rev/min.

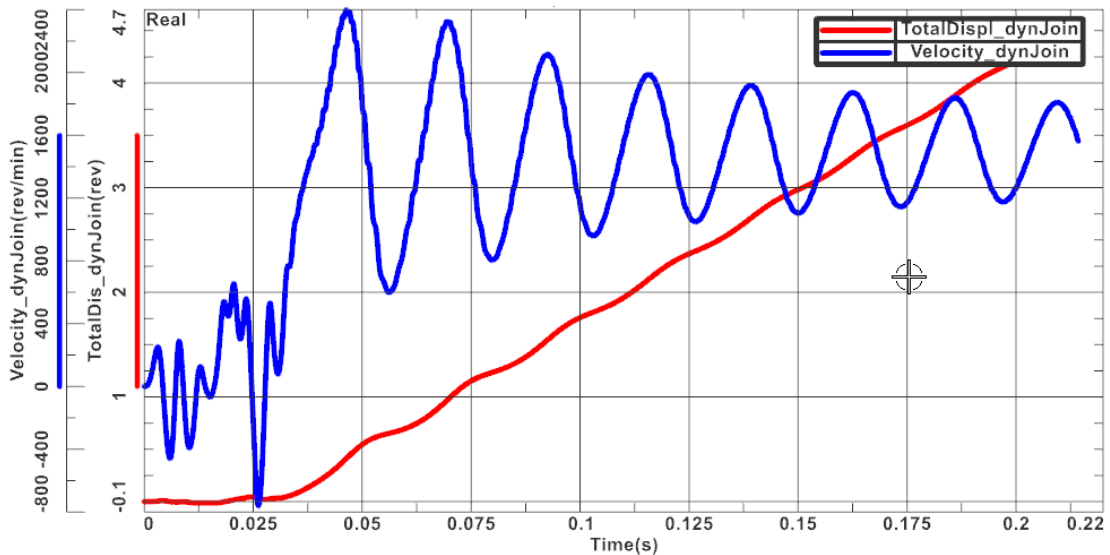

- Torque over time. The torque becomes smaller the more we reach synchronous speed.

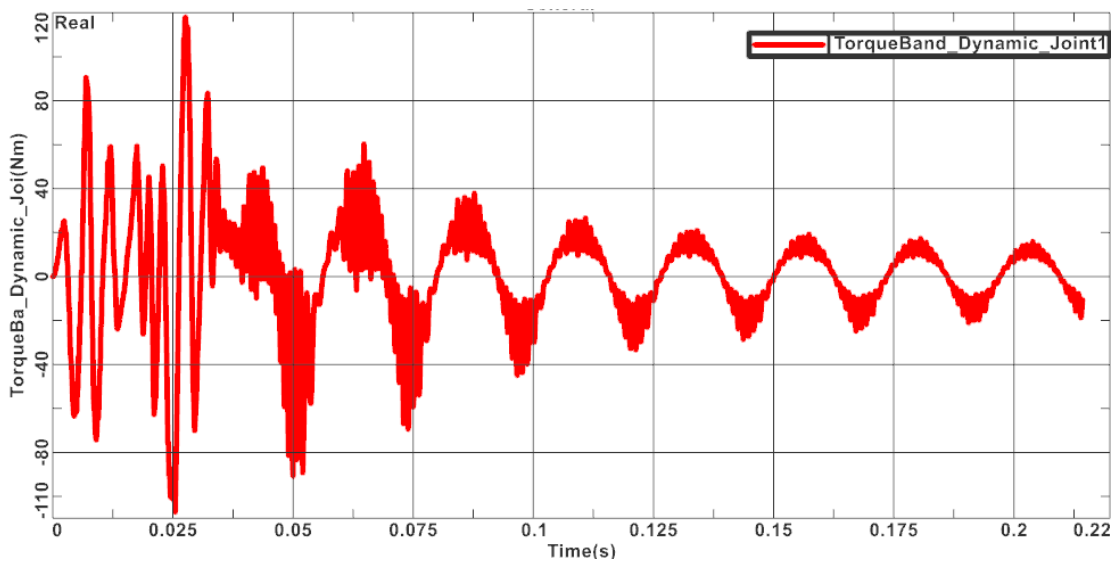

6.1.8 3D Model of Induction Motor

In the complete folder of the tutorial there is also a 3D model of the motor that is set up pretty much the same as the 2D model from the beginning. This 3D model would additionally allow to study end effects and other 3D specific effects. The thickness is reduced to 12.7 mm. So, if results shall be compared to the 2D model, this must be set to the same thickness. All used features can be found in the model files.

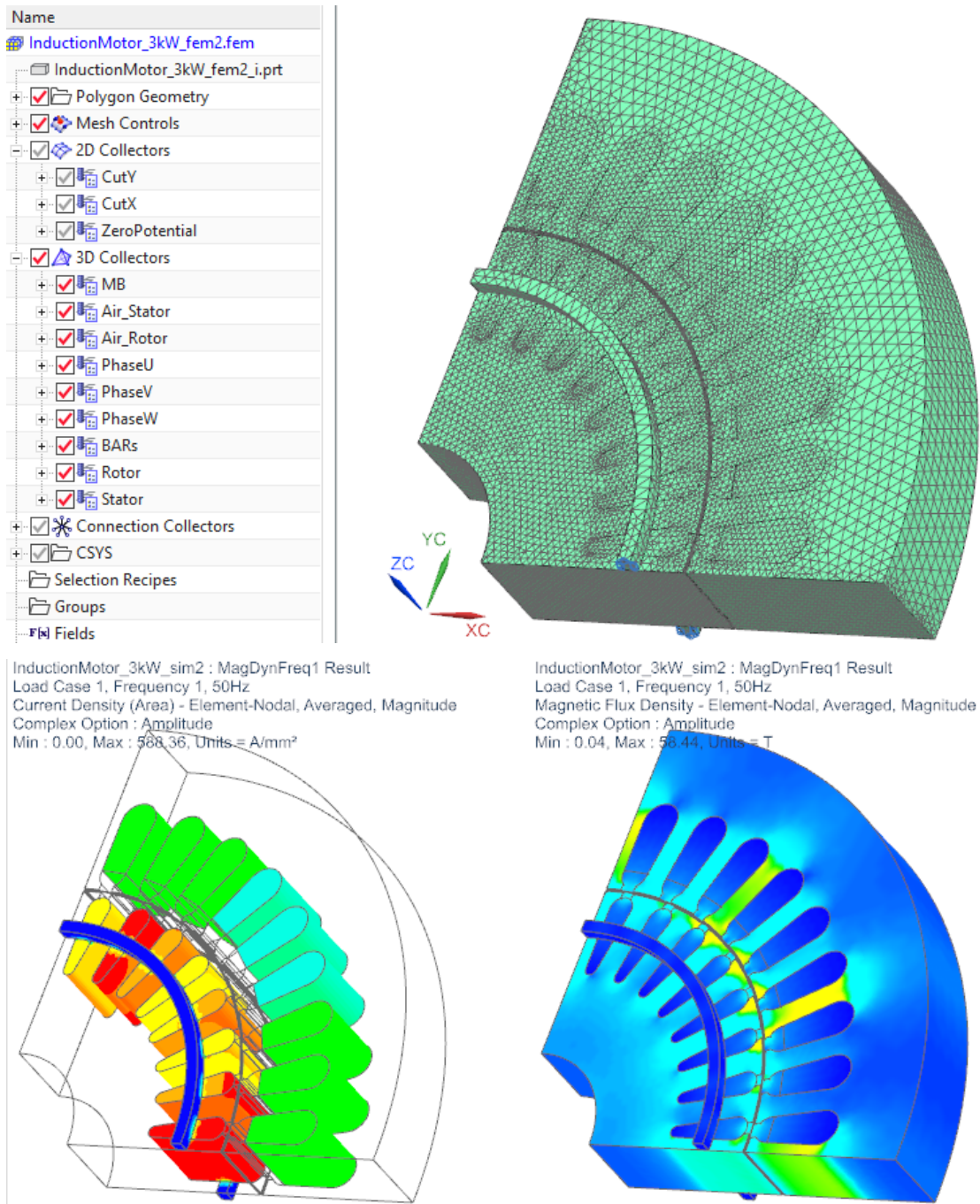

1. Open the file 'InductionMotor_3kW_sim2.sim' from folder 'complete'.
2. First check the solution 'MagDynFreq1'. It is from type 'Magnetdynamic Frequency' with

50Hz. For 'Output Requests' we are interested in the RotorBand-Torque, the 'Current Density' and the 'Magnetic Fluxdensity'.

3. Switch to the fem file.
4. Notice that there are three 2D mesh collectors. The 'CutY' and the 'CutX' collector, that contain the meshes of the cutted faces and the 'ZeroPotential' collector.
5. Open the 'CutY' collector to see the meshes. Every 'CutY' mesh has a corresponding mesh in the 'CutX' collector. Those are created by the '2D Dependent' feature.
6. Click 'Edit' on 'CutX4' to see the settings of this mesh. For 'Master Face' the upper face is selected, the program automatically selects the corresponding 'Target Face' on the other side of the motor. It also selects the 'Master' and 'Target Edges'. It is important, that the arrows of the 'Master' and 'Target Edge' point in the same direction.

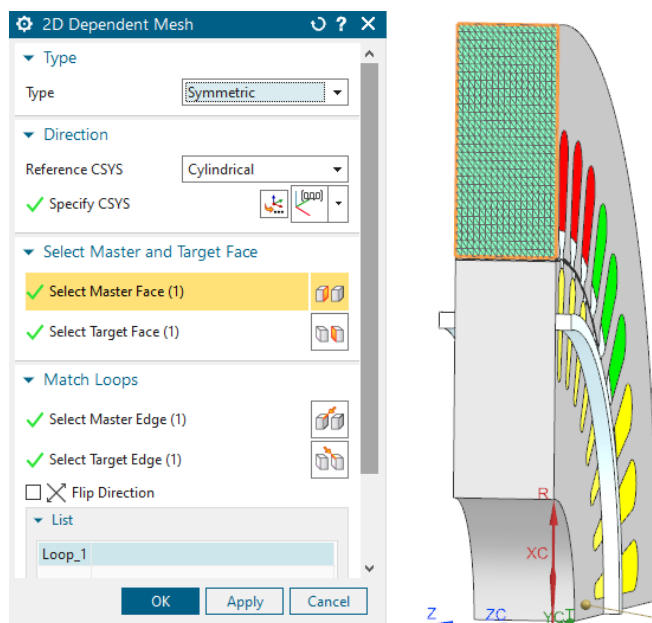

7. Check the 3D collectors. We use the same physical properties as in the 2D simulation.
8. Now switch to the sim file.
9. Check the 'Simulation Object' in the solution.
10. It is from type 'Enforced Motion 3D Frequency', for 'Moving Parts' the 'Rotor Air', the 'Bars' and the 'Rotor' are selected.
11. For 'Airgap 1 Ring' the 'Moving Band' is selected, and the 'Angular Velocity' is set to 800 rev/min.

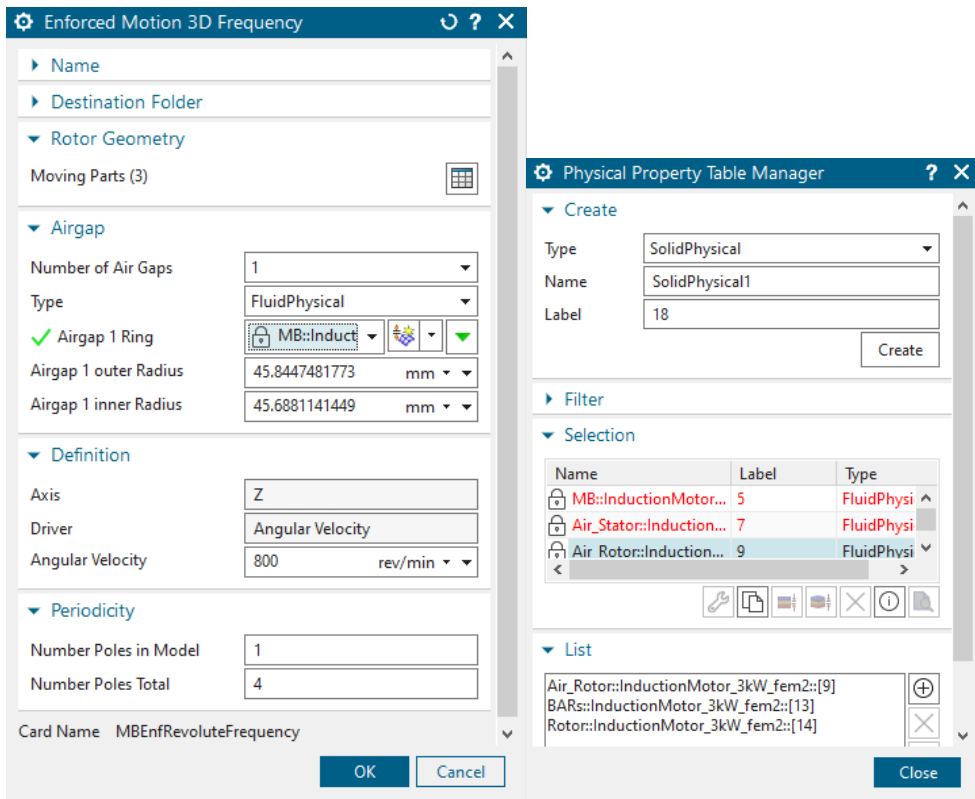

- Check the Constant, 'Link(1)'. For 'Independent' the 'CutY' physical is selected, for 'Dependent' the 'CutX'. The 'Coupling' is similar to the 2D link.

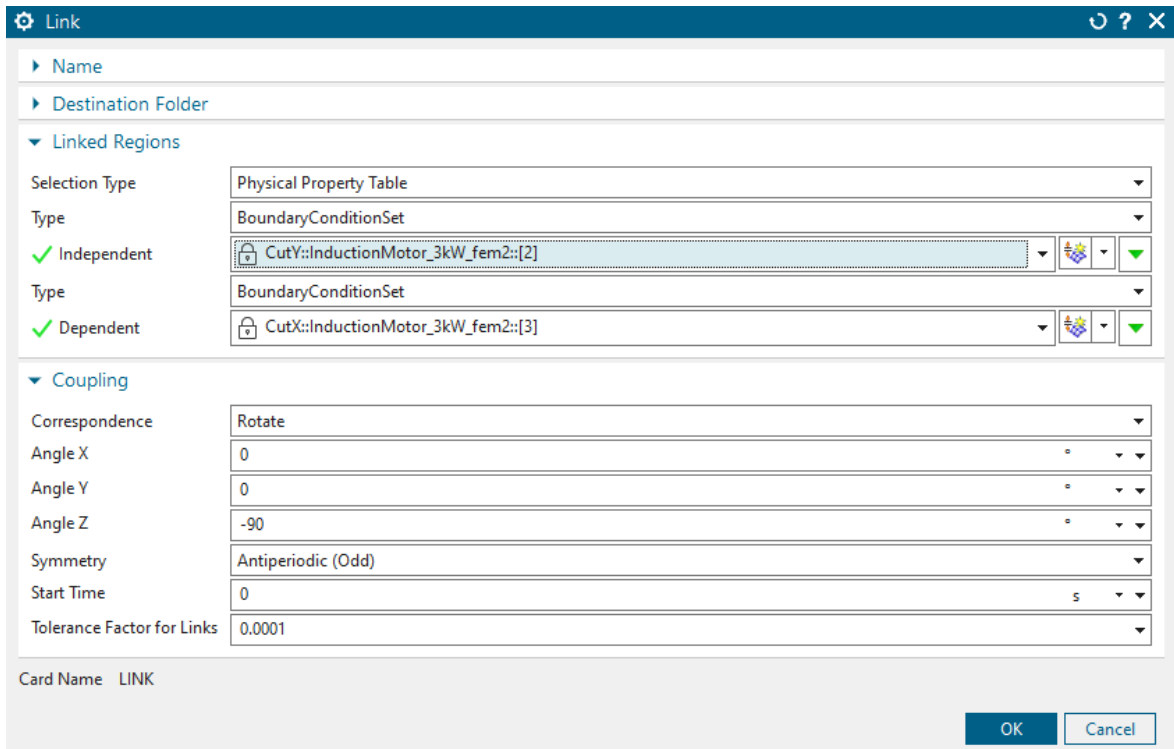

- Open the 'Loads'.
- Now have a look at the loads. Load 'U', 'V' and 'W' are shifted by -120° . They have a

amplitude of 77.7817 V.

15. Now solve the solution.

6.1.9 Post Processing

1. Open the AFU-Graph of the 'RotorTorque_Enforced'.

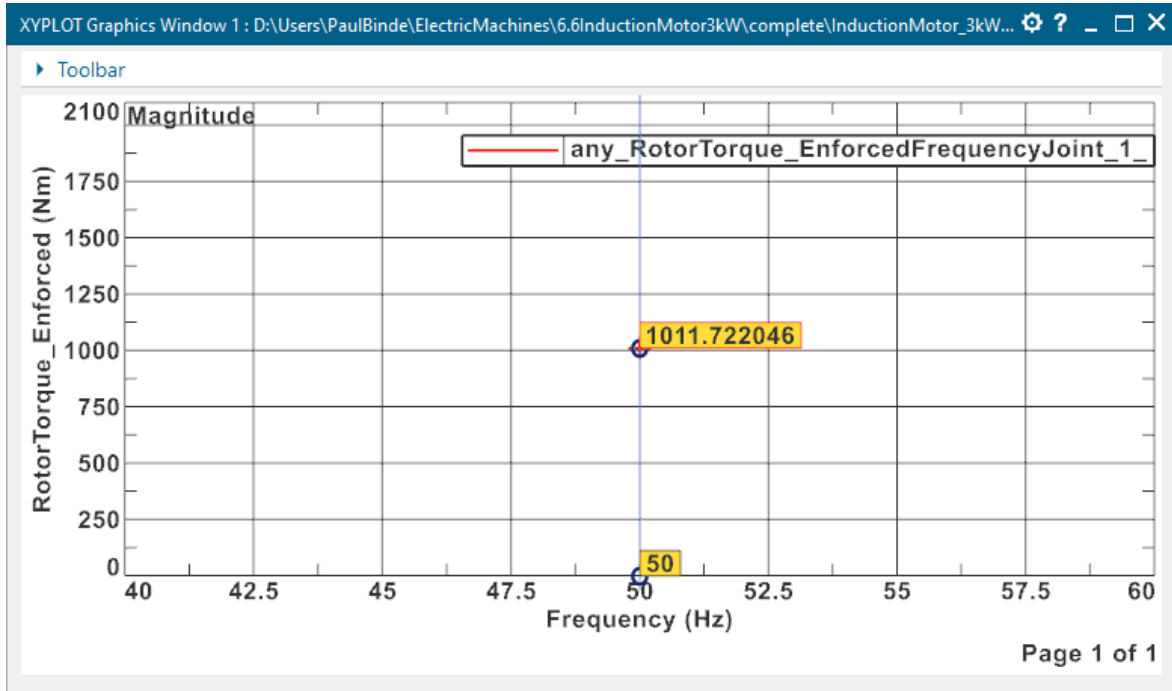

2. To compare this picture shows the torque of the 2D model with the same thickness. The torque has almost the same value.

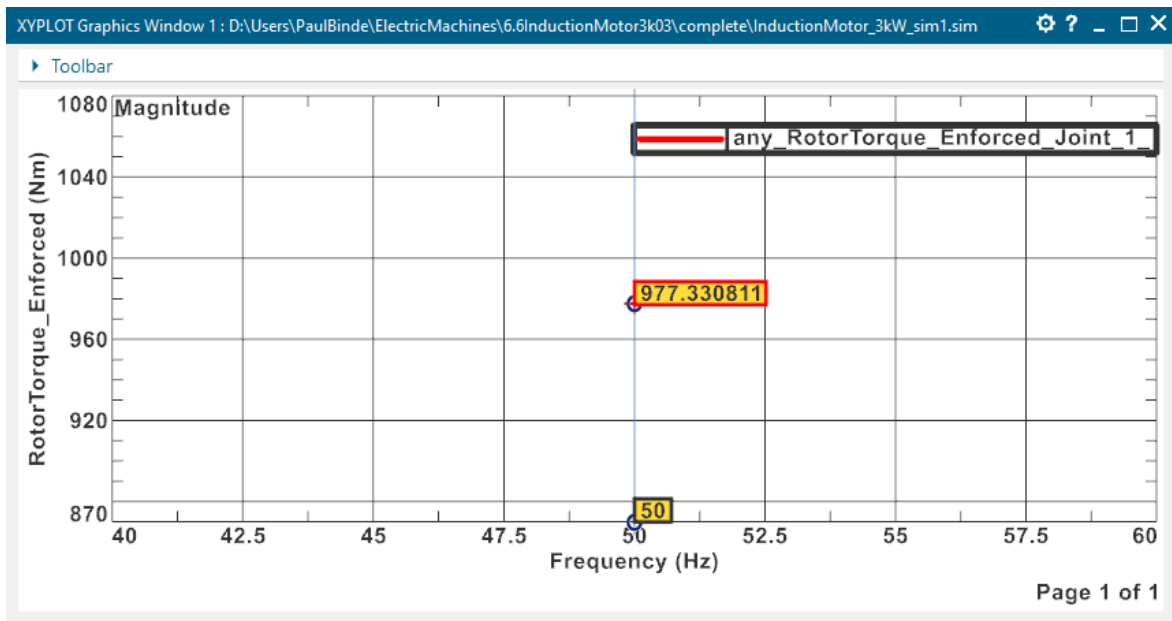

The tutorial is complete.

7 Tutorial 6

7.1 Motor (Team30) with Moving Band/Constant Rotor Shape (Conductor Motion)

In some cases there is motion, but the geometry remains constant. This is the case for instance if the rotor is a simple tube as in the following example. In such situations the simulation is much simpler, because all movements can be handled solver internally, thus we can use the feature 'Conductor Motion const Shape'. For comparison we first solve this model with a moving band and then again with conductor motion.

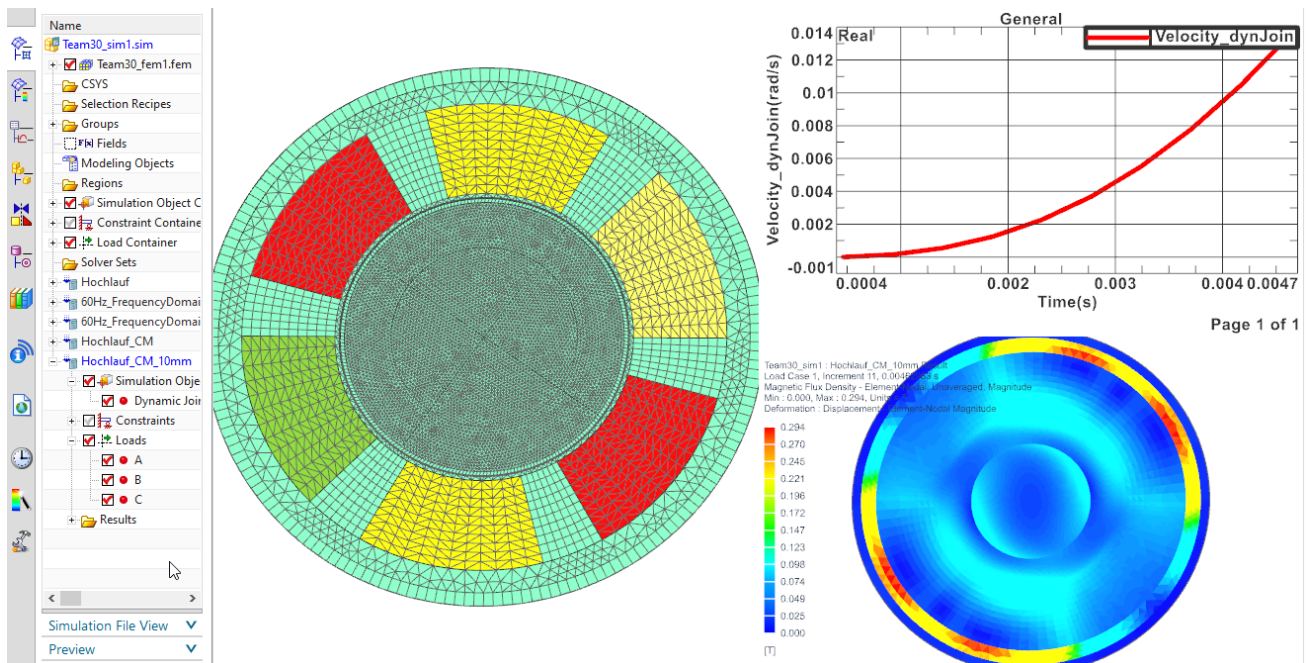

The following tutorial shows such an application. Example is the induction motor 'TEAM30' that is one of the Compumag reference models.

1. Download the model files for this tutorial from the following link:
<https://www.magnetics.de/downloads/Tutorials/6.CouplMotion/6.1InductionMotorTeam30.zip>
2. Open the file Team30.prt.
3. Create a new Sim and Fem file(Non-Manifold) from 'Magnetics' Toolbar.
4. Use solver MAGNETICS, Analysis type '2D or axisym Electromagnetics' and Solution Type 'Magnetodynamic Transient'.
5. Name the solution 'Hochlauf' (e.g. start-up).
6. Activate the desired data in Output Requests (here we activate 'Rotorband Torque')

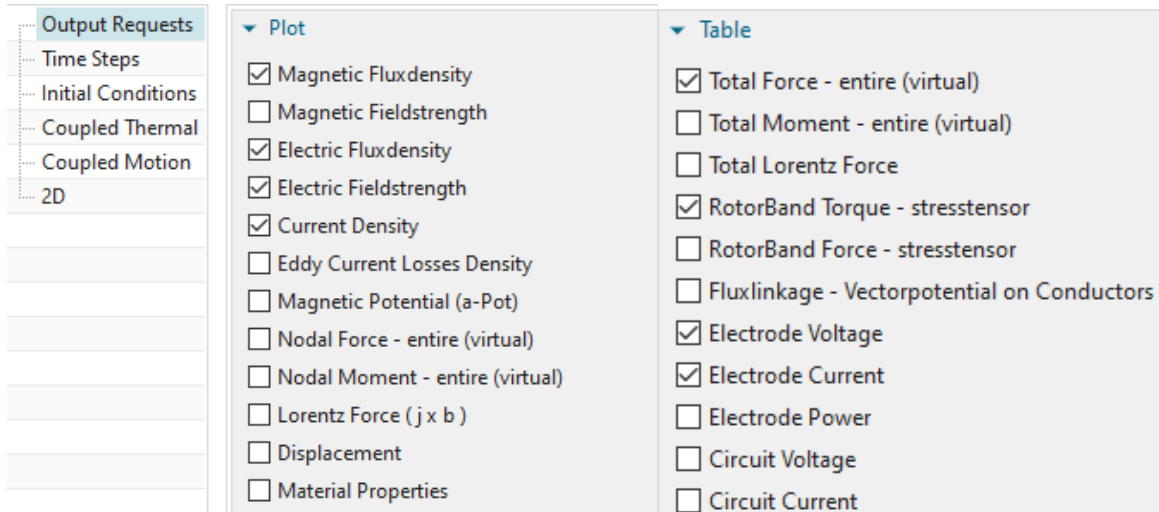

7. In time steps, set the 'Time Increment' to 1/2160 and the 'Number of Time Steps' to 10.
8. Set the Electromagnetic fields as shown in the 'Initial Conditions' options.

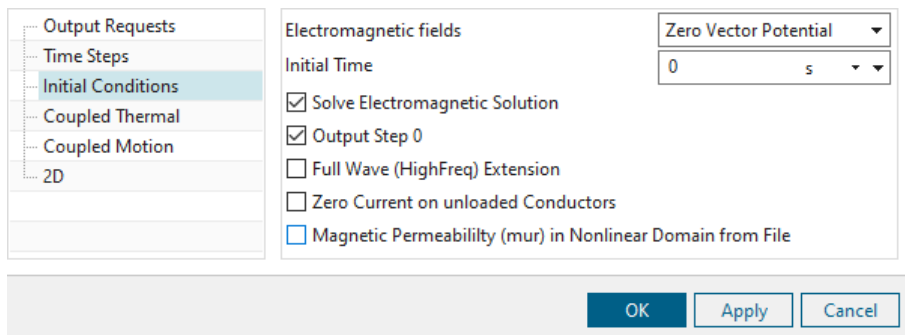

9. Click OK.
10. Switch to the FEM file.
11. Mesh the inner part of the air gap (quads, 0.75mm) and use FluidPhysical and 'Air'.

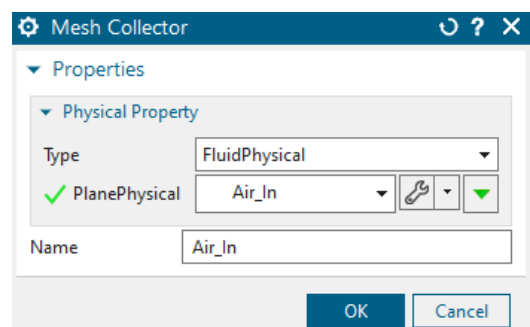
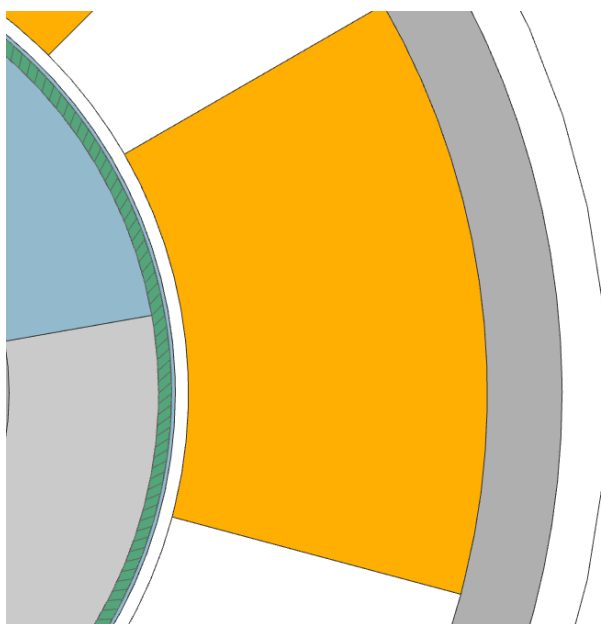

12. The outer air consists of 3 different quad meshes. Mesh the inner circle with 1mm and the outer circle with 4mm. Mesh the gaps between the coils with a 2D Mapped Mesh and the Element Size of 2mm. Assign the fluid Physical and select the material 'Air'.

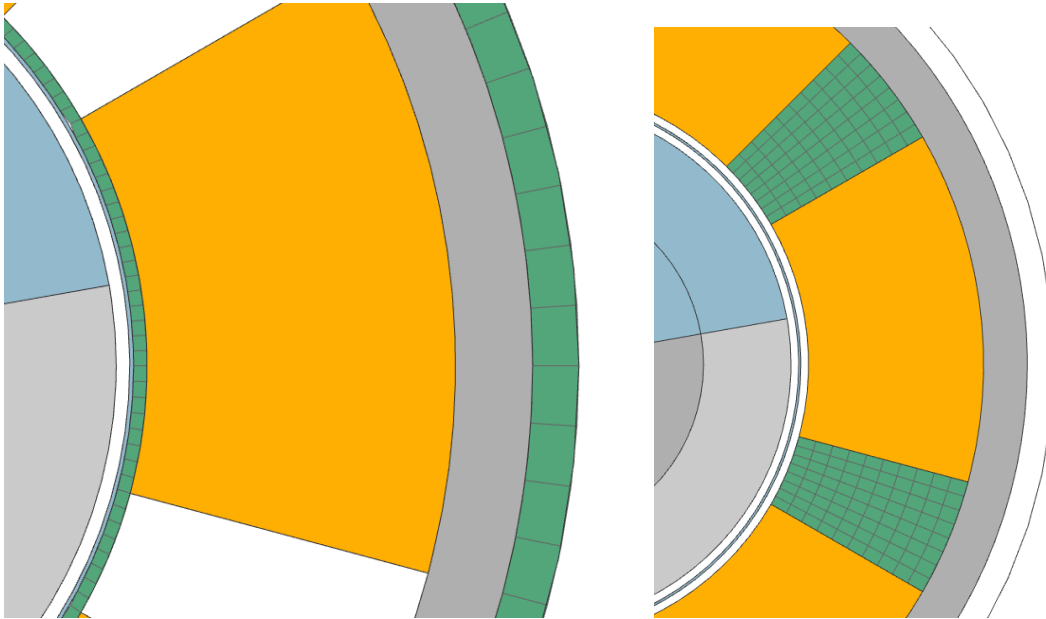

13. Mesh the Stator with tri meshes and an element size of 2mm.

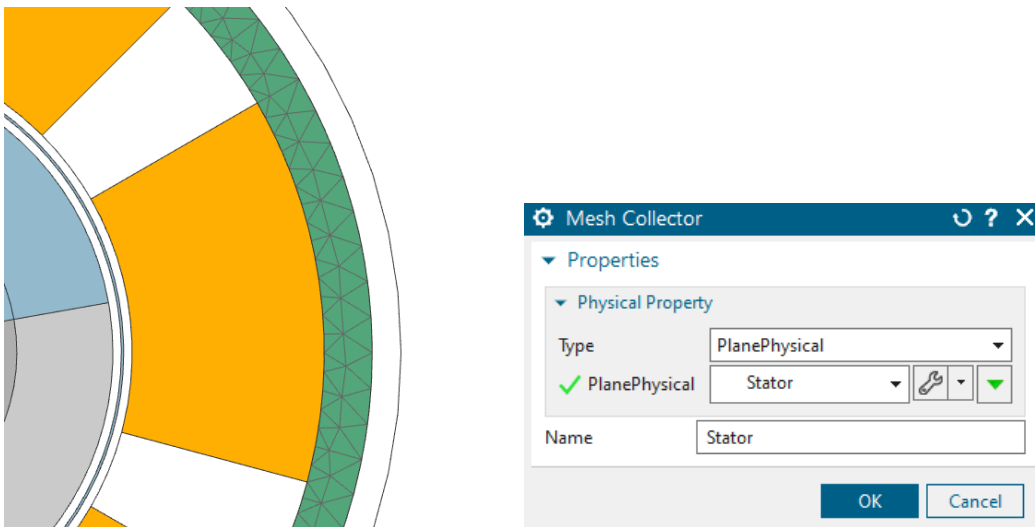

14. Edit the physicals and create a new Material with the name 'Team_30_Steel_Non_Con'. In 'View' select All Properties and add the electromagnetic properties as seen in the picture below.

Mechanical	▼ MAGNETICS Solver EM Properties	
Strength	Info about the used Model	The 'Low Frequency' Model (above) is also possible and preferred
Durability	Electric Conductivity Type	Constant/Table
Formability	Electric Conductivity (sigma) [S/m]	0
Thermal	Electric relative Permittivity (epsr)	1
Electromagnetic	Magnetic Permeability Type	Linear, mur
Creep	Magnetic relative Permeability (mur)	30
Viscoelasticity	Magnetic Remanent Fieldstrength X (hr)	0 A/m
Viscoplasticity	Magnetic Demagnetization Fieldstrength	A/m
Damage		
Other Physical Properties		
Pedestrian Protection		

15. Mesh the Rotor_Steel with tri meshes and an element size of 0.75mm.

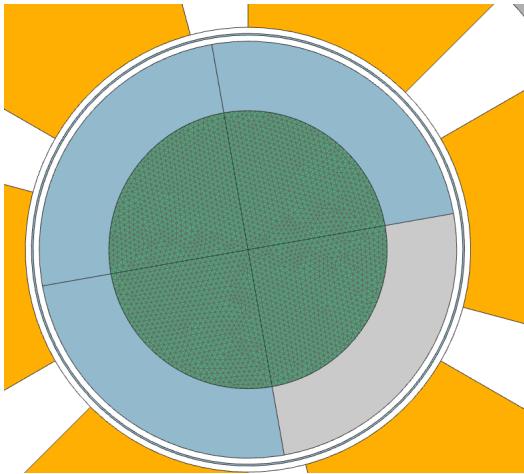

16. Edit the physicals and create a new Material with the name 'Team_30_RotorSteel'

17. In 'View' select 'All Properties' and add the electromagnetic properties as seen in the picture below.

Mechanical	▼ MAGNETICS Solver EM Properties	
Strength	Info about the used Model	The 'Low Frequency' Model (above) is also possible and preferred
Durability	Electric Conductivity Type	Constant/Table
Formability	Electric Conductivity (sigma) [S/m]	1.6e6
Thermal	Electric relative Permittivity (epsr)	1
Electromagnetic	Magnetic Permeability Type	Linear, mur
Creep	Magnetic relative Permeability (mur)	30
Viscoelasticity	Magnetic Remanent Fieldstrength X (hr)	0 A/m
Viscoplasticity	Magnetic Demagnetization Fieldstrength	A/m
Damage		
Other Physical Properties		
Pedestrian Protection		

18. Mesh the Rotor_Aluminum (tri, 0.75mm) and choose material Aluminum: 3.8×10^7 Siemens/meter. Set the Inertia RZ to 4688 kgmm^2

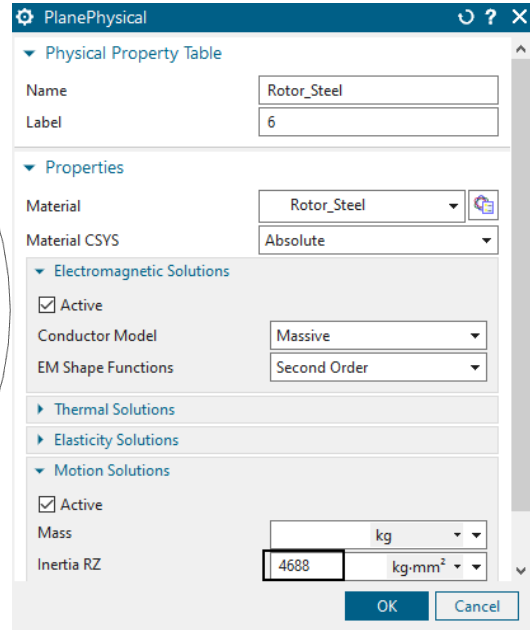
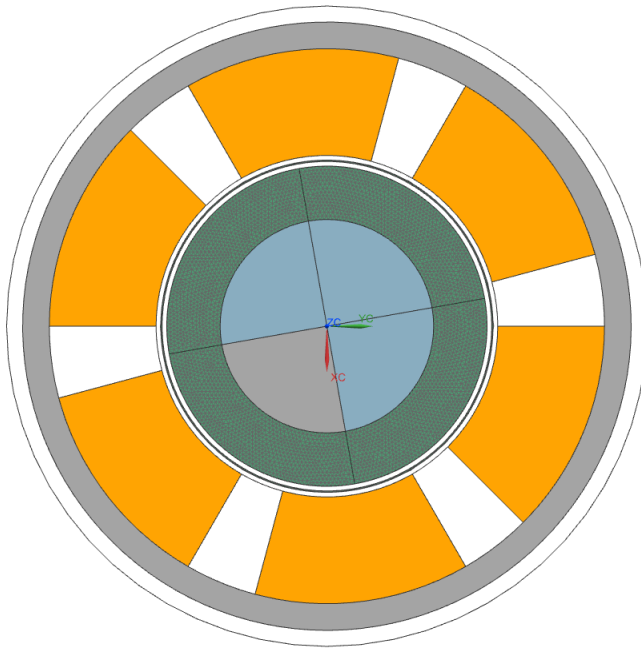

19. Mesh all the coils (tri, 0.75mm) and for each coil set the physical as shown in the picture below.

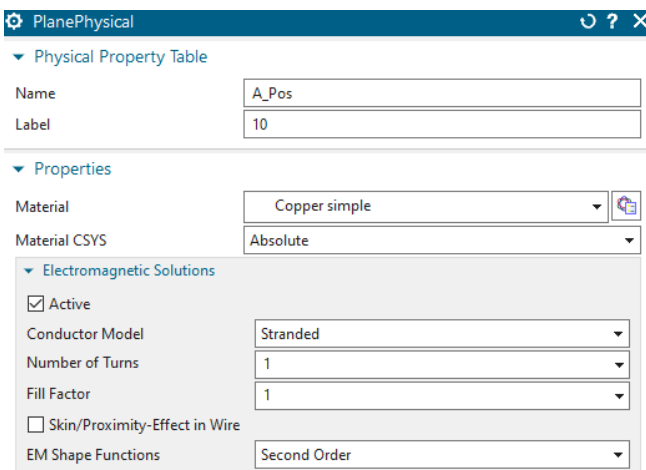

20. Mesh the Airgap (tri, 1.69mm) and choose fluid and Air.

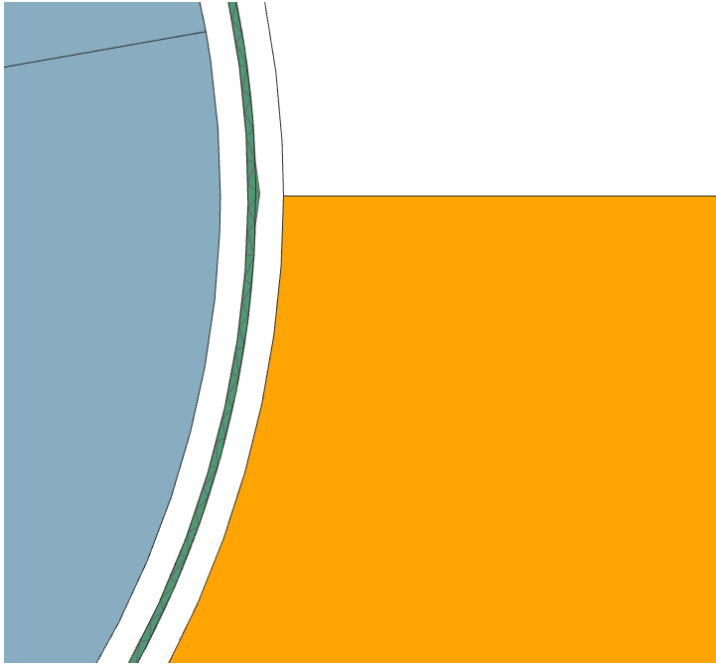

21. We are done with the FEM file.
22. Change the window to the Sim file.

7.1.1 Simulation with Moving Band

1. In this section we will use a Moving band to allow the rotor to move.
2. Create a simulation object 'Enforced Motion 2D' and select type 'Revolute by Moving Band'. Select the 'Airgap Rotor Edge' and the 'Airgap Stator Edge'. Use the same setting as seen in the picture below.

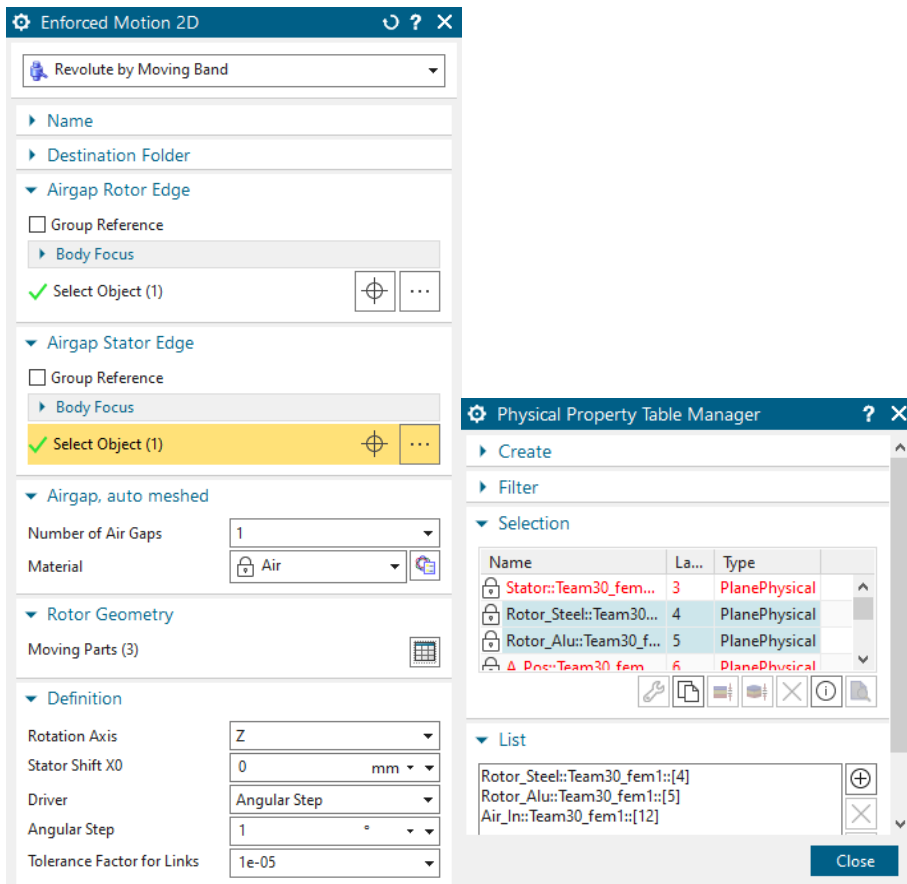

3. Create another Simulation object, 'Deactivation Set' and select the airgap in 'Deactivated Physicals':

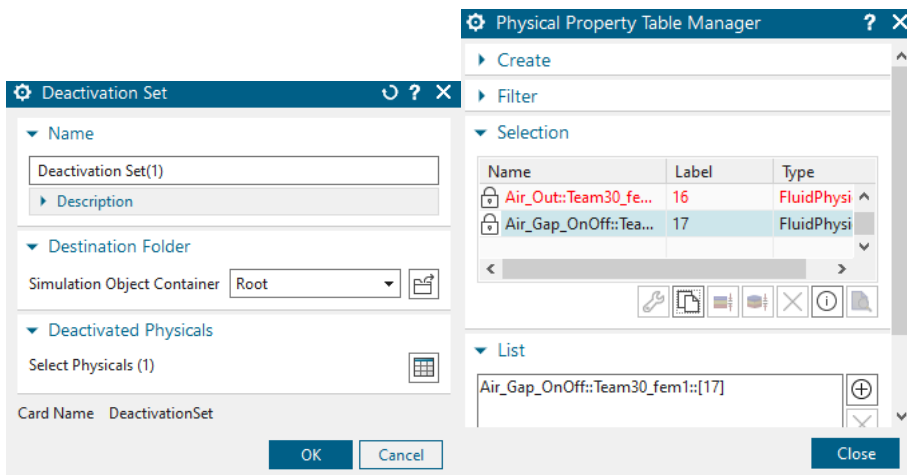

4. Create a Constraint of type 'Flux Target' and select the outside edge of 'Air_Out'.

5. Lastly we create the Loads.

6. Create a Current and select the settings as below.

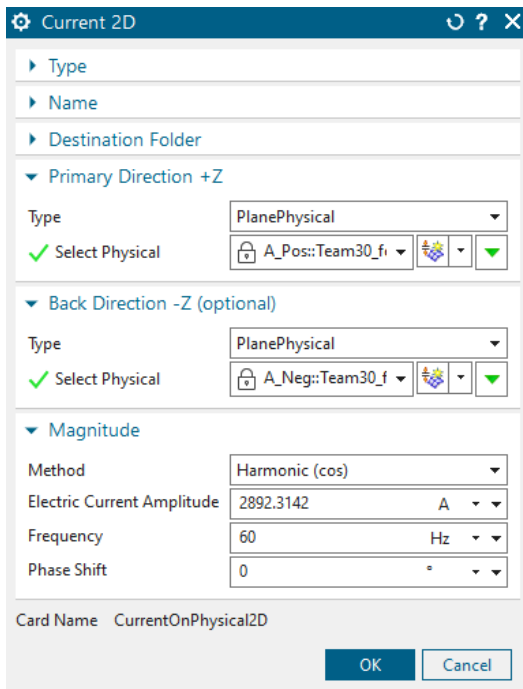

7. Create two more currents 'B' and 'C'. Select the same settings and add a phase shift of 120° for 'B' and 240° for 'C'.

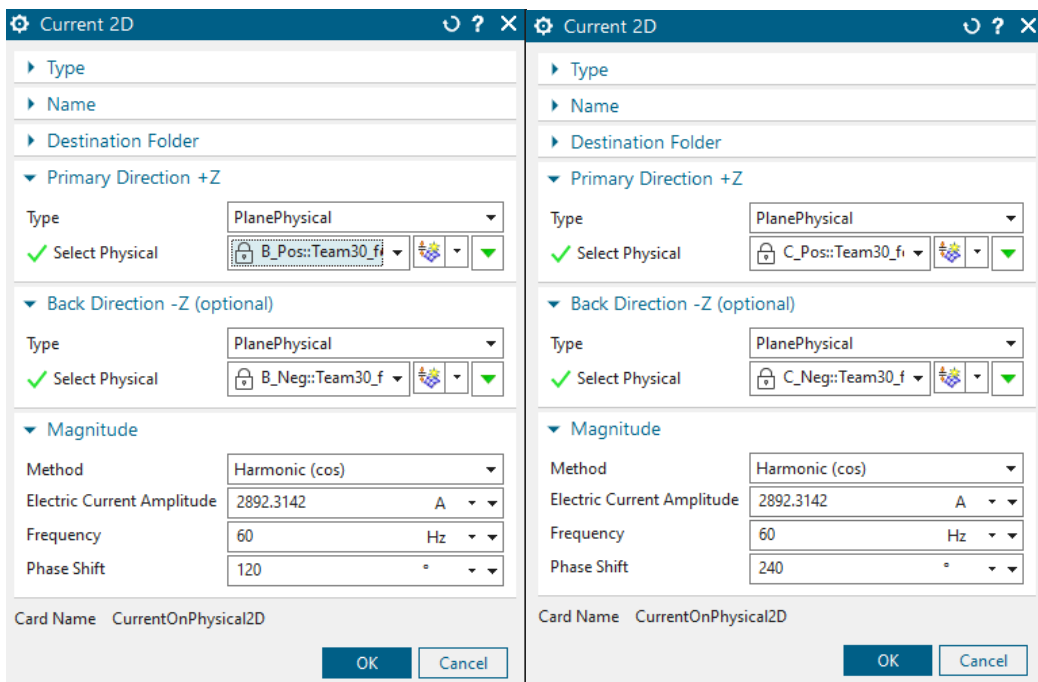

8. Solve the solution.

7.1.2 Post Processing

1. Display the graph results for the velocity. This should look like in the following picture:

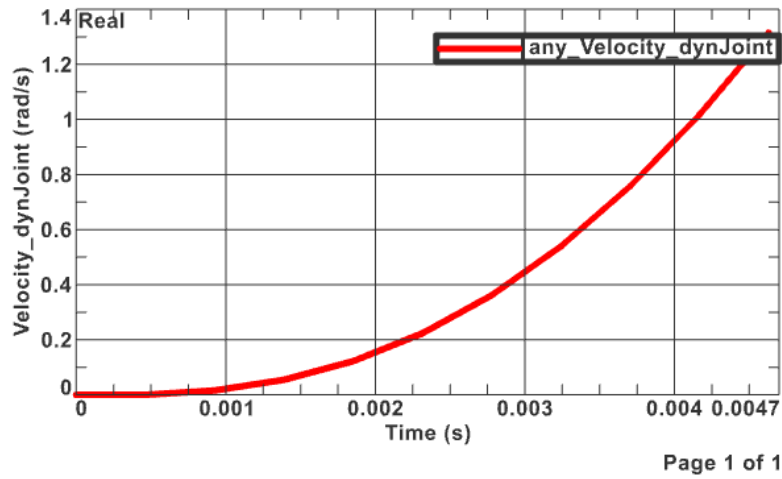

2. This picture shows the 'Magnetic Flux Density' of the motor:

Team30_sim1 : Hochlauf Result
 Load Case 1, Increment 1, 4.630E-04s
 Magnetic Flux Density - Element-Nodal, Unaveraged, Magnitude
 Min : 0.000, Max : 0.422, Units = T
 CSYS : Absolute Rectangular

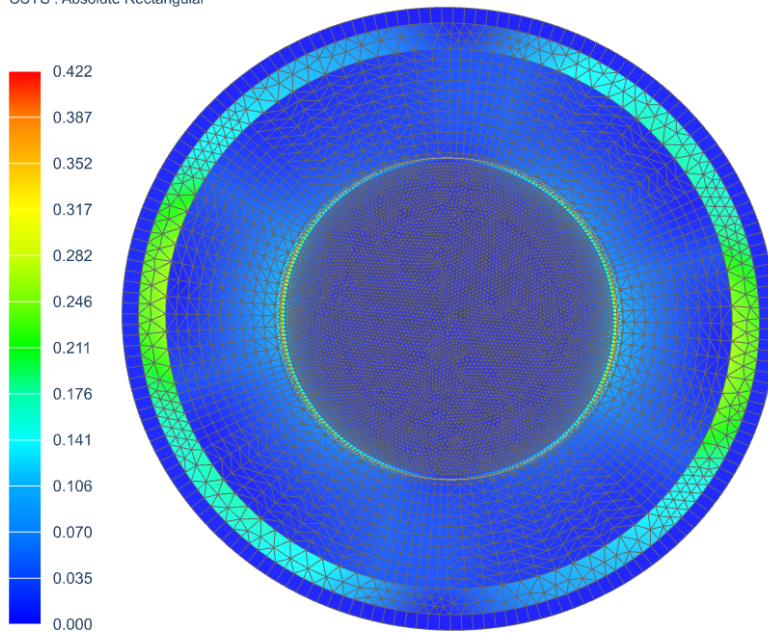

[7]

7.1.3 Solution with Conductor Motion

1. Clone the solution
2. Instead of using the Moving band, we are now going to use the type 'Conductor Motion'.
3. Delete the two existing simulation objects. Create then a new one of type 'Dynamic Motion 2D' with the following settings:

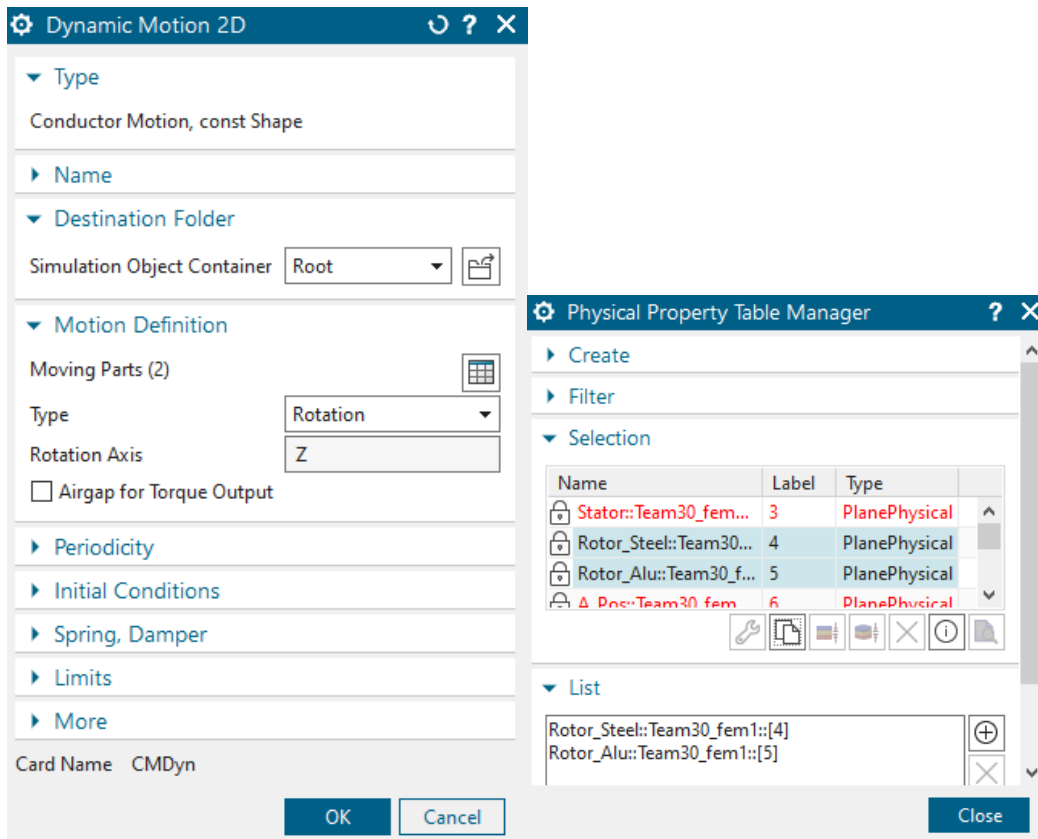

4. Solve the solution.

7.1.4 Post Processing

The result graphs should match with the graphs of the 'Hochlauf' solution.

The tutorial is completed.

7.2 Motor (Team30_3D) with Conductor Motion

In this simulation, we are going to look at the same motor but in a 3 dimensional space.

1. Open the file Team30_3D.prt.
2. Create a new Sim and Fem file(Non-Manifold) from 'Magnetics' Toolbar.
3. Use solver MAGNETICS, Analysis type '3D Electromagnetics' and Solution Type 'Magnetodynamic Transient'.
4. Name the solution 'Hochlauf' (e.g. start-up).
5. Activate the desired data in Output Requests (here we activate 'Rotorband Torque')
6. In time steps, set the 'Time Increment' to 1/2160 and the 'Number of Time Steps' to 10.

7. Set the 'Electromagnetic fields' as shown in the 'Initial Conditions' options.

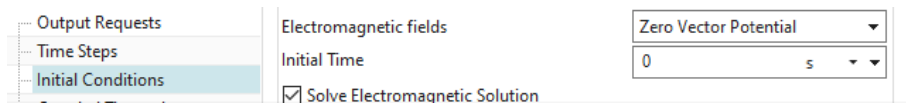

8. Click OK.

9. Switch to the FEM file.

10. Mesh the 'Air' using tets (3.2/2 mm)

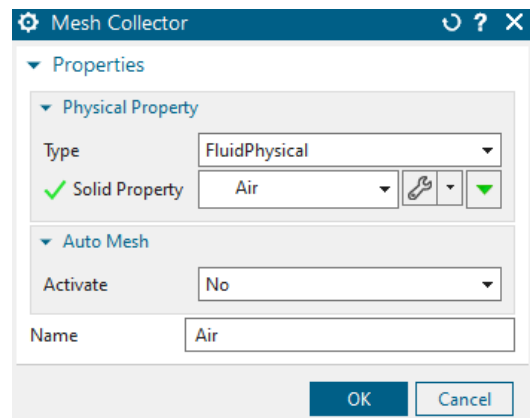
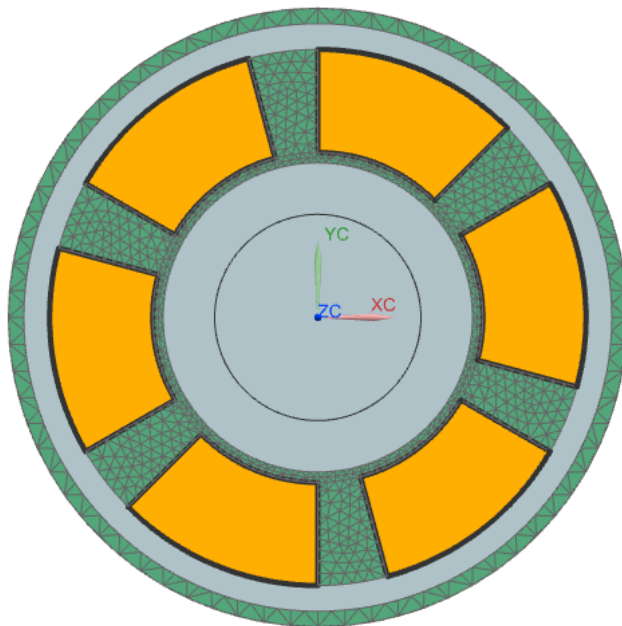

11. Mesh the 'Stator' with tets and an element size of 5.25/2 mm.

12. Add the same material to the 'Stator', which was used in the 2D simulation.

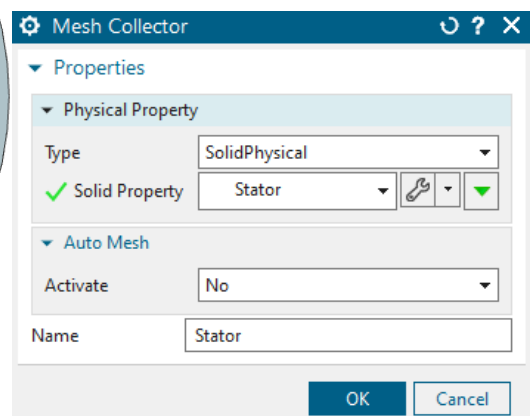
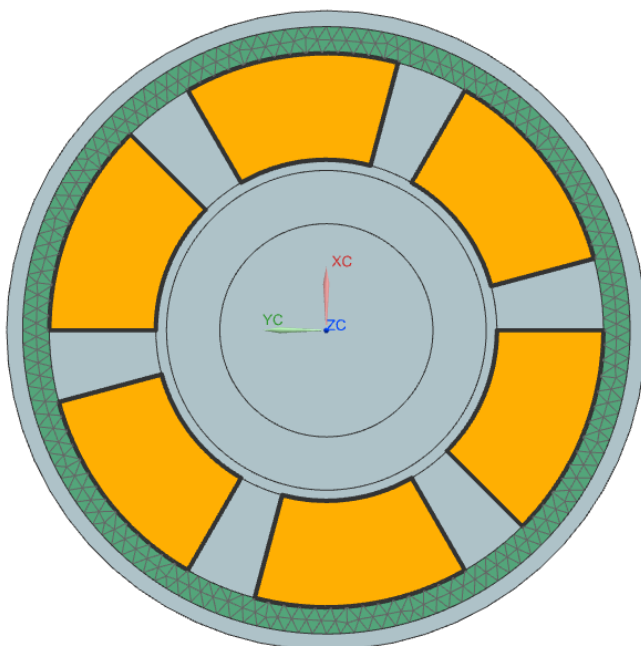

13. Mesh the 'Rotor_Aluminum' with tets and use the element size of 5.1/2mm.
14. Add the same material to the 'Rotor_Aluminum', which was used in the 2D simulation.

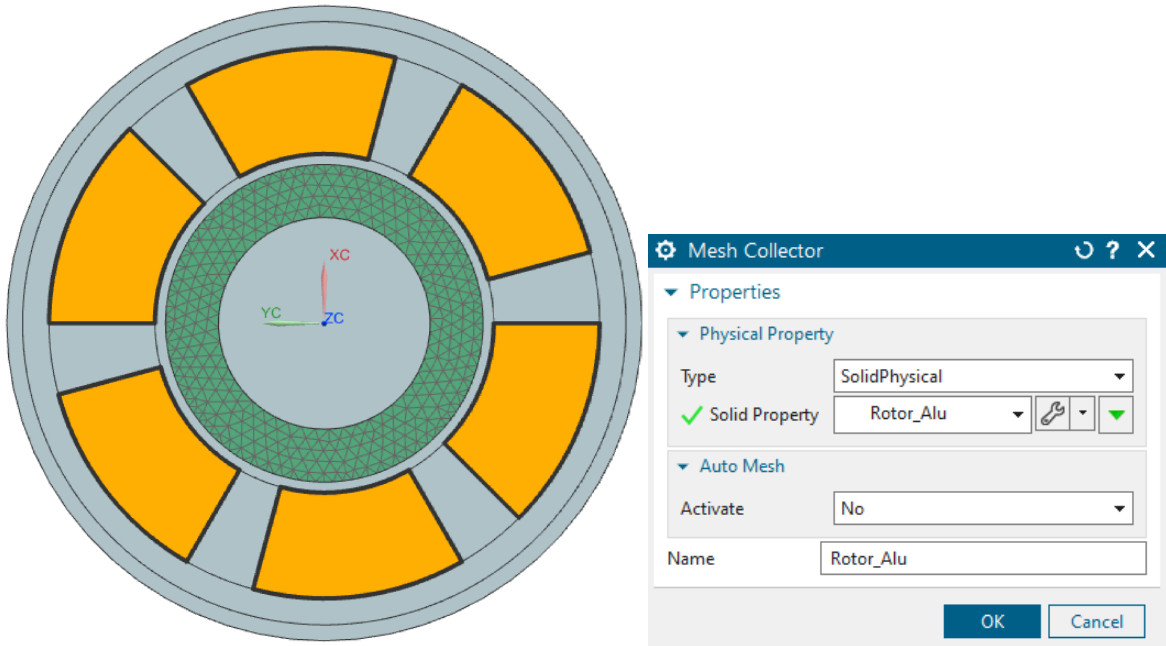

15. Mesh the 'Rotor_Steel' with tets and use the element size of 7.67/2 mm and use the same material, which was used in the 2D simulation.

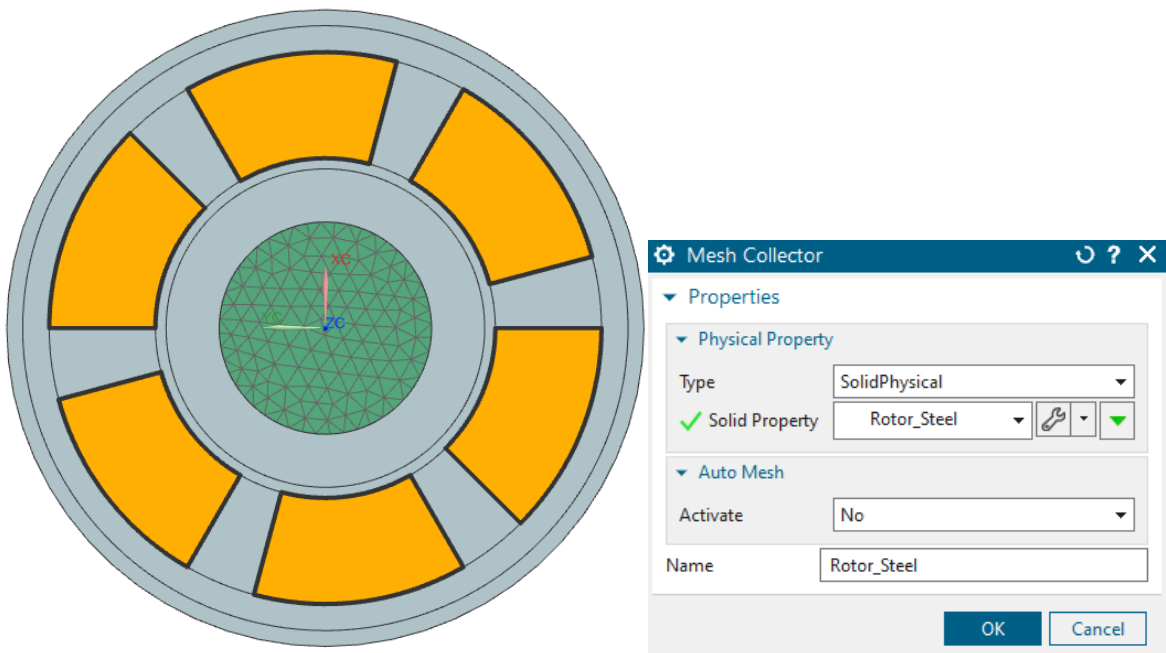

16. Mesh every coil using tets and an element size of 6.04/2 mm. Set the physicals for each coil as shown in the picture below.

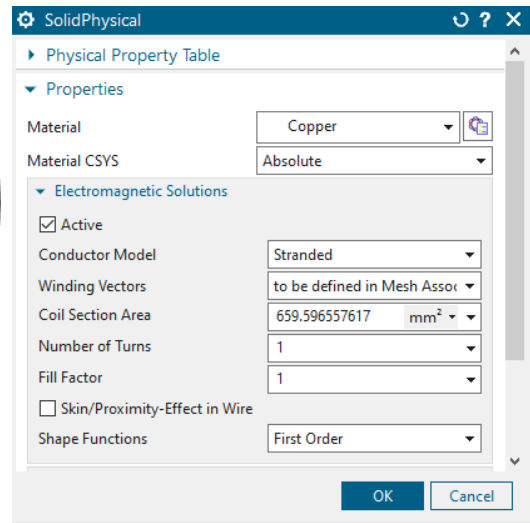
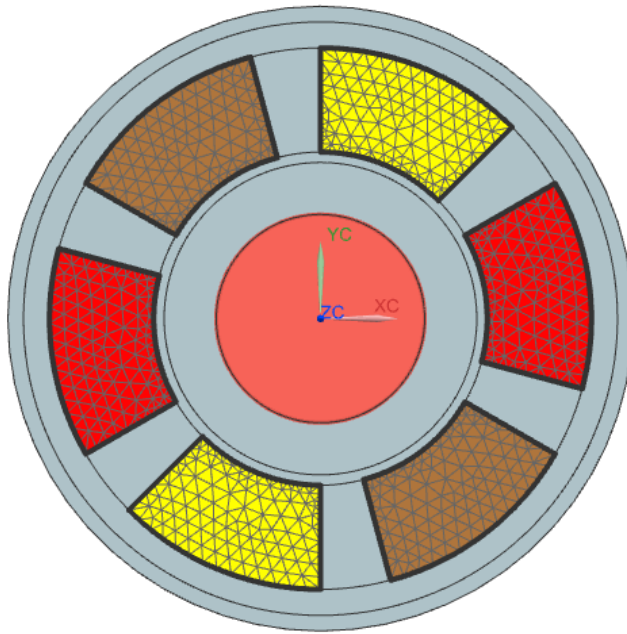

17. Edit the 'Mesh associated data' and select one of the vertical, outer lines (highlighted edge in the picture below).

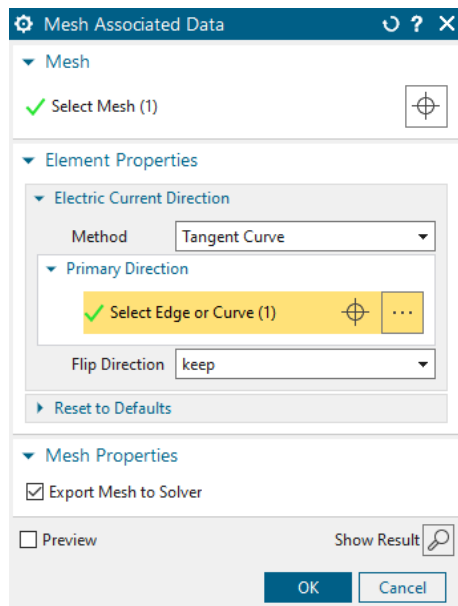
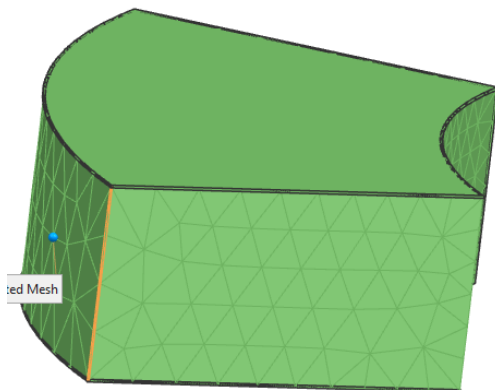

18. We are done with the FEM file.

19. Change the window to the Sim file.

20. Create a simulation object 'Dynamic Motion' of type 'Conductor Motion'. Select the moving parts as seen in the picture below.

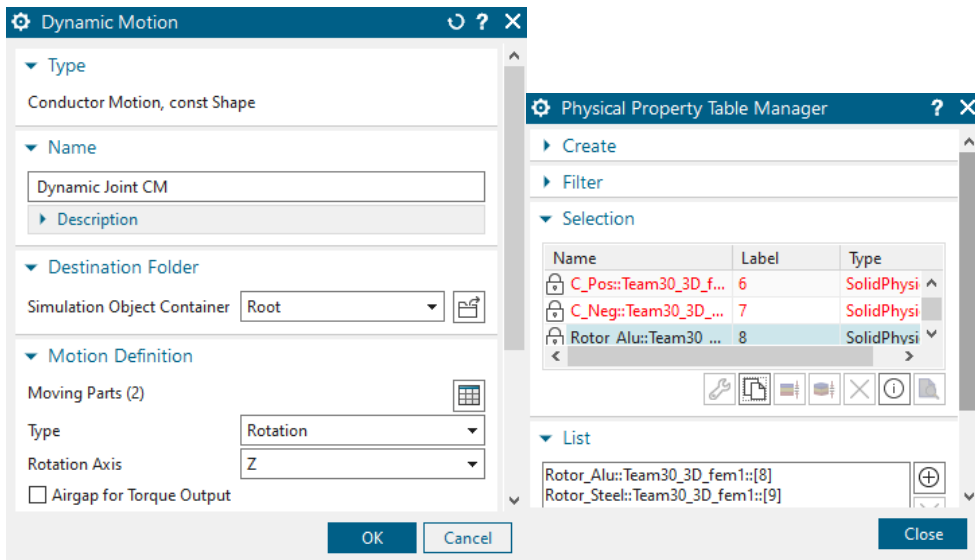

21. The only constraint we use here is a 'Flux Tangent'. Select all outside faces (35 in total).

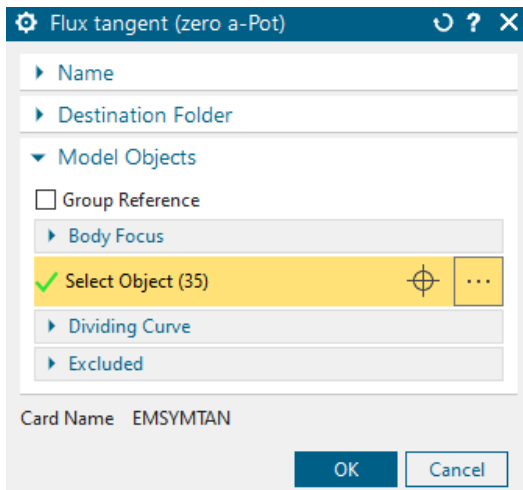

22. Lastly, we create the loads. Every pole has a positive and a negative current, so we have to add a load of 2892.3142 amps to the positive and a load of - 2892.3142 amps to the negative coil.

23. A: Phase shift of 0°

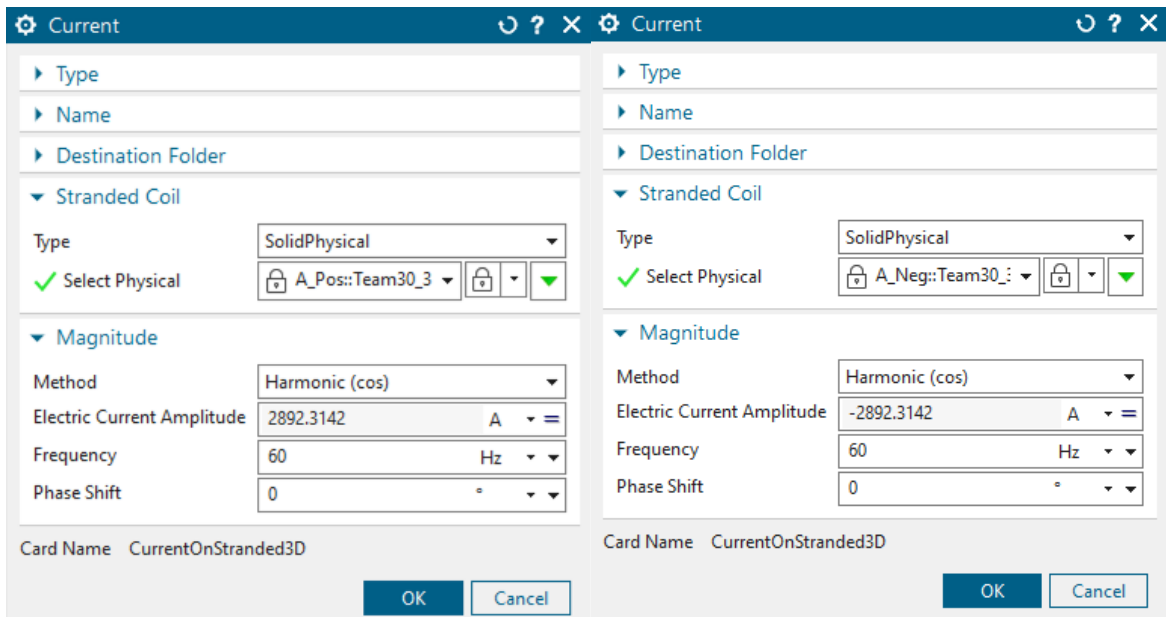

24. B: phase shift of 120°

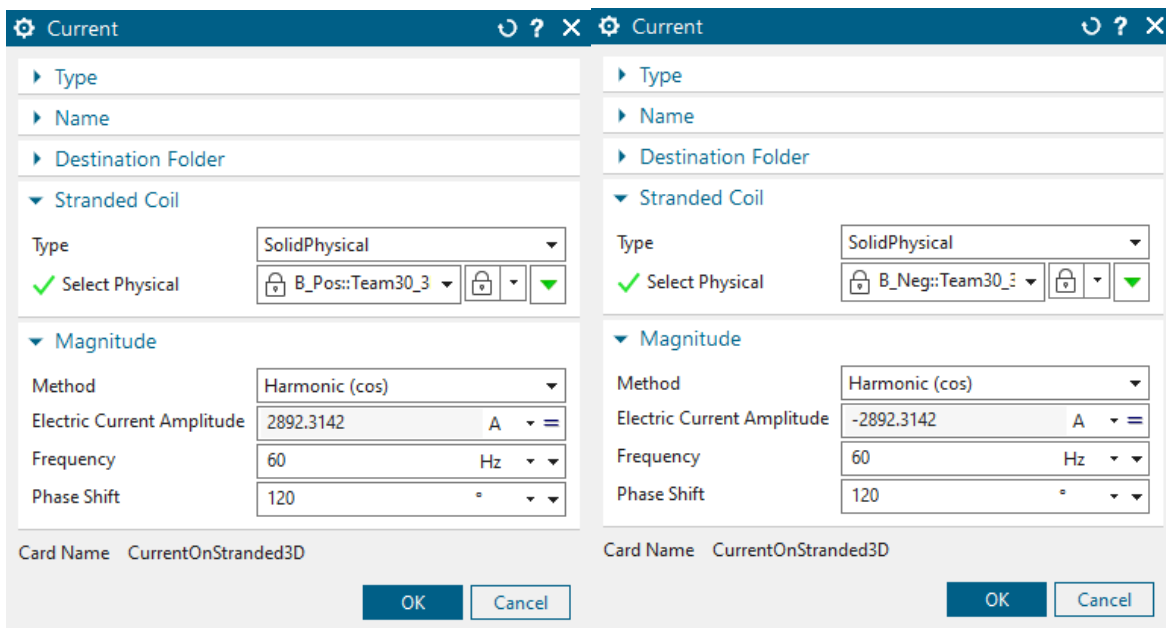

25. C: phase shift of 240°

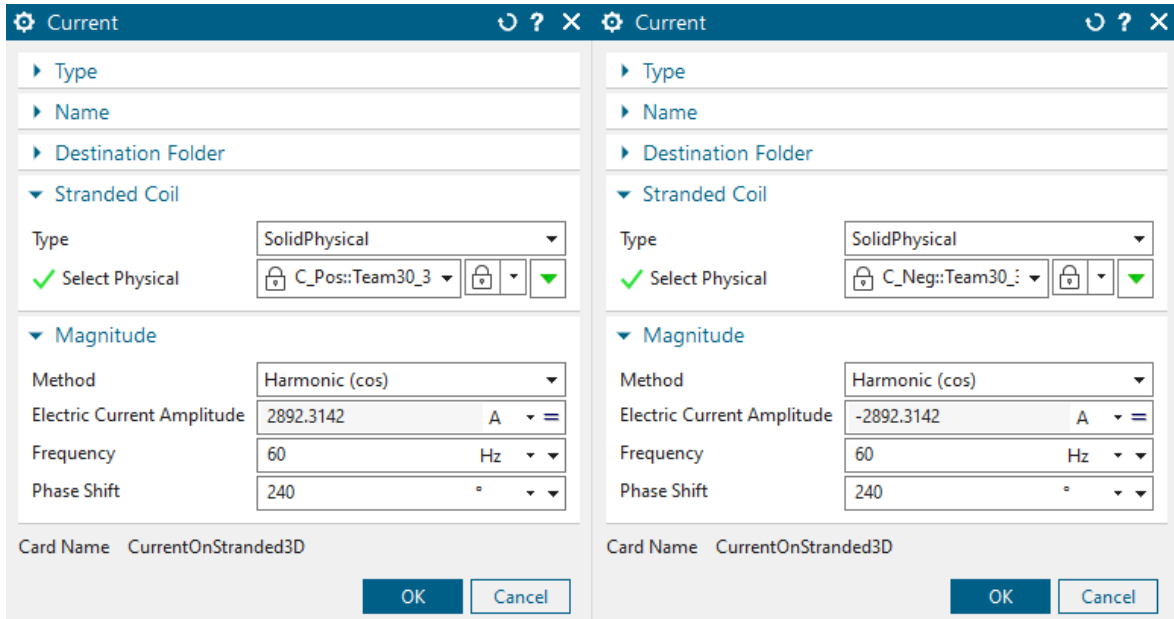

26. Solve the solution.

27. The results should be similar to the ones from the 2D simulation.

8 Tutorial 7

8.1 Motor Analysis in 3D by Sliding Motion

In this tutorial we analyze a permanent magnet electric motor in 3D. For motion we use the Sliding Motion technique. A Fem and Sim file are already created and in this exercise we walk through the existing model to check and explain the used features.

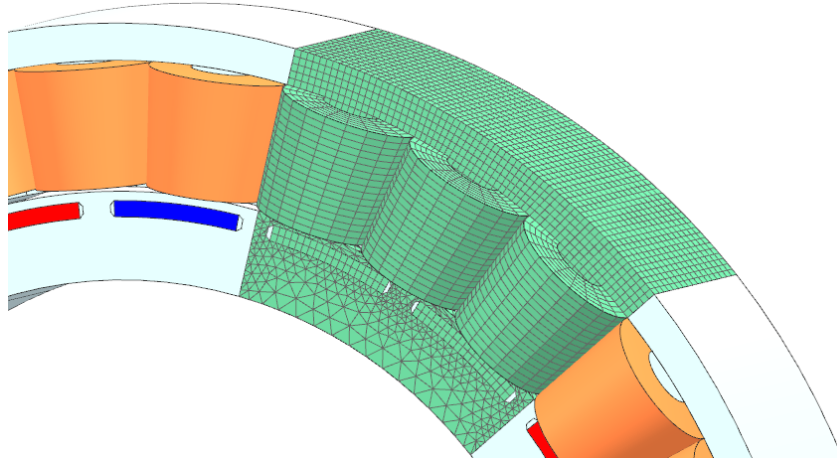

In this tutorial the motor is set up in 3D but also in 2D. Both models base on a 2D skeleton geometry. The skeleton contains only basic dimensions and allows geometry updates into both simulation models. For working on such motors in practice we recommend the process shown here: Having both 2D and 3D simulation models in parallel. Because in 2D solving runs much faster, it is a good idea to first test many things using the 2D model and when this runs fine, set up the 3D model in the same way and investigate the 3D behaviour.

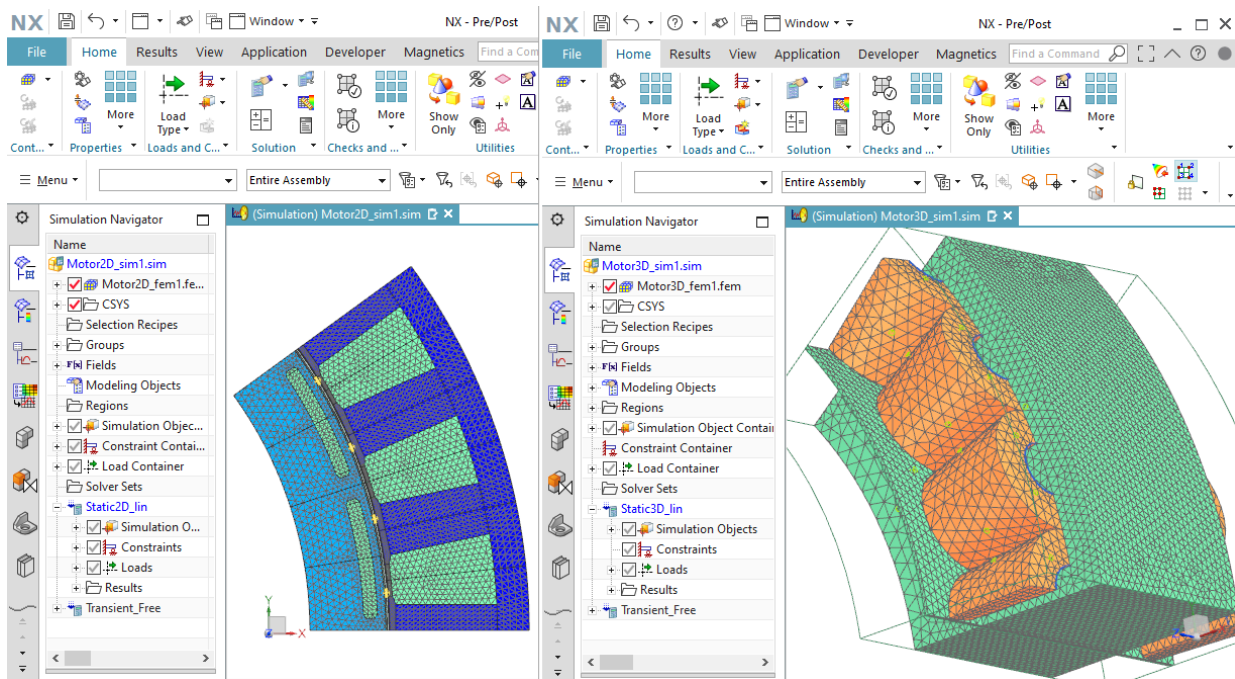

Previous tutorials already have shown features for 2D models, so we now will concentrate on the 3D model. The following files contain all features for the set up of the model. There is also a youtube video (click Link) available for this example.

- Download the model files for this tutorial from the following link:
<https://www.magnetics.de/downloads/Tutorials/6.CouplMotion/6.7Motor3D.zip>
- Open the file 'Motor3D_sim1.sim'.
- Change the displayed part to the Fem file to check the following steps.

8.1.1 Properties for Sliding Surface

In models that use the Sliding Surface technique, there must be such two contacting surfaces that later will slide. Normally this sliding is designed into the air gap of the motor. If a motor has two such air gaps it is also possible to define two such sliding surface pairs. It is important that the sliding surfaces have the following properties:

- One surface must be connected to the rotor and the other surface must be connected to the stator. At the contact, the two surfaces do NOT share the same nodes. Mesh Mating Conditions using the option 'Free Coincident' allow for such a condition. Following we call such two surfaces 'Sur_SlidingMaster' (the one at the stator) and 'Sur_SlidingSlave' (the one at the rotor). The software will create link constraints between the edges of these two.
- The surface must be meshed in structured way. So, when rotation appears, the link condition can snap from one element edge to the following. The optimal step size is exactly the element size, but rotor positions in between such snap points are also possible, because the neighbouring 3D elements are allowed to be slightly deformed to meet such positions.

The following picture shows the position of the sliding surfaces in the tutorial motor. Also there is shown the neighbouring 3D element layer, called 'MB'. In this layer we allow the deformation of elements. Also this layer is used to compute the torque results using the maxwell stress tensor technique. The right picture below shows the special Mesh Mating Conditions on those faces that belong to the sliding surface. The symbols show their type 'Free Coincident'.

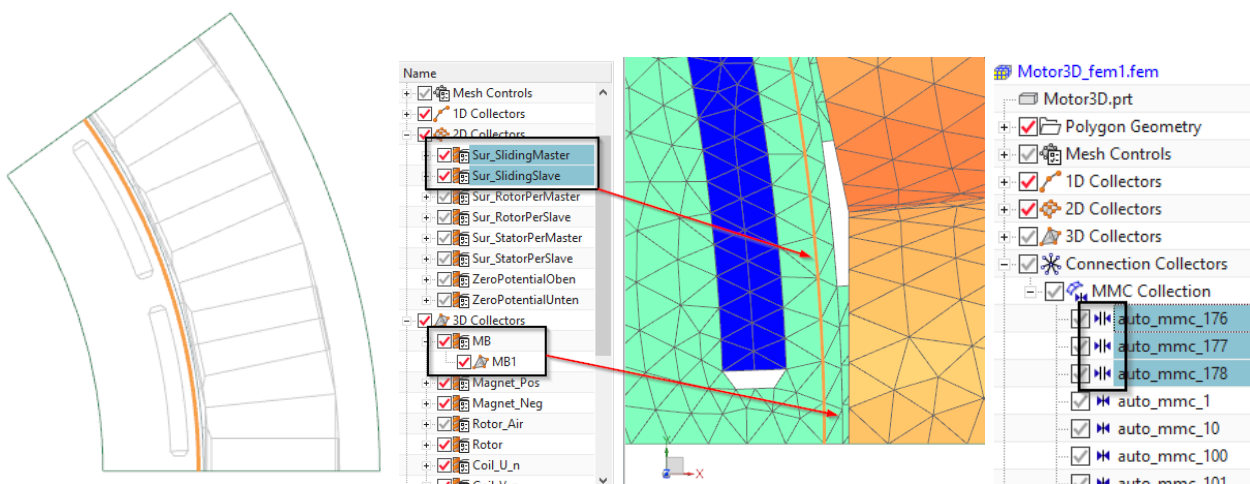

Also, for checking the sliding surface conditions for correctness, it is a good idea to ask the model for duplicate nodes. This check must show all nodes at the sliding surfaces highlighting. See picture below.

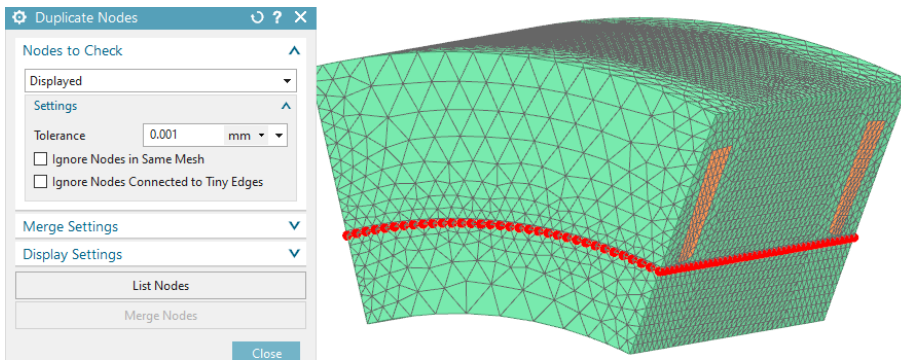

8.1.2 Properties for Periodicity Segments

Of course, to keep simulation time as short as possible, one should exploit the periodicity that most motors have. Therefore, we will model a link constraint between the right and left section faces of the motor segment. The following recommendations are given:

- These section faces are meshed at the very beginning of the meshing process using the '2D Dependent' meshing feature.
- The resulting 2D meshes at these periodicity faces will later be referenced in a link condition. Therefore we will call such 2D meshes as follows:
- 'Sur_RotorPerMaster': The faces on the right (master) side, belonging to the rotor.

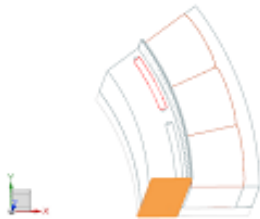

- 'Sur_RotorPerSlave': The faces on the left (slave) side, belonging to the rotor.

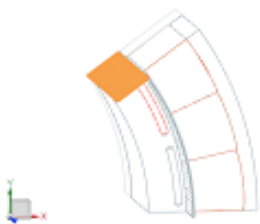

- 'Sur_StatorPerMaster': The faces on the right side, belonging to the stator.

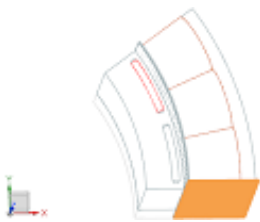

- 'Sur_StatorPerSlave': The faces on the left side, belonging to the stator.

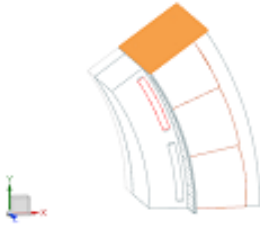

8.1.3 The Rotor Joint Definition

Most specific definitions for the sliding surface technique are in a simulation object. So we take a closer look on that side.

1. Change the displayed part to the Sim file for the following steps.
2. Edit and check the simulation object 'Enforced Joint(1)'. Notice its Card Name, it is a 'SMEnfRevolute', meaning an 'Enforced Revolute by Sliding Motion'.
3. Only the 'Driver' and the step size (of Velocity) are defined in this dialogue. All remaining definitions correspond to the geometrical description of the rotor and are stored in a modeling object 'Rotor Geometry Definition1'.
4. Edit that modeling object to see its properties. There are several boxes to define the geometry. We walk through them following.

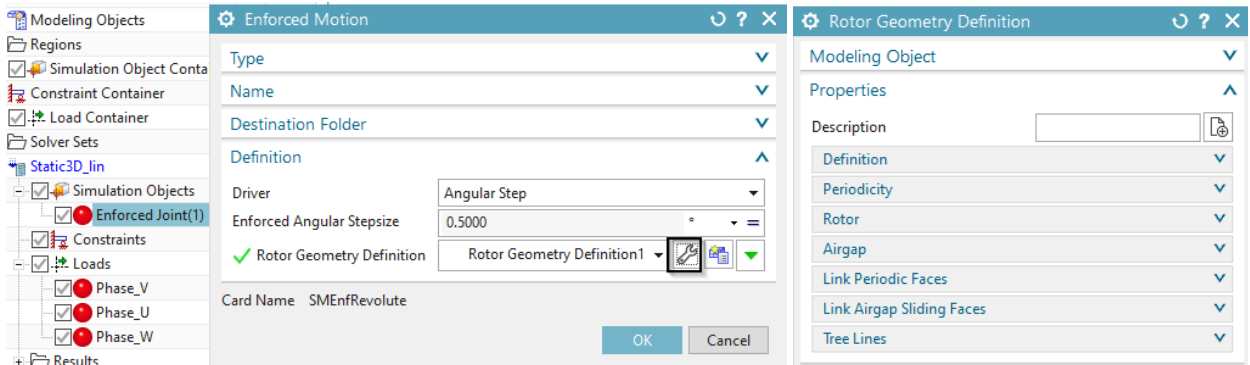

5. The 'Definition' box gives some information about the orientation of the model. A button 'Show Orientation Image' can be set. The model must be oriented in this way: Rotation is about global X and the start position must be aligned with X.

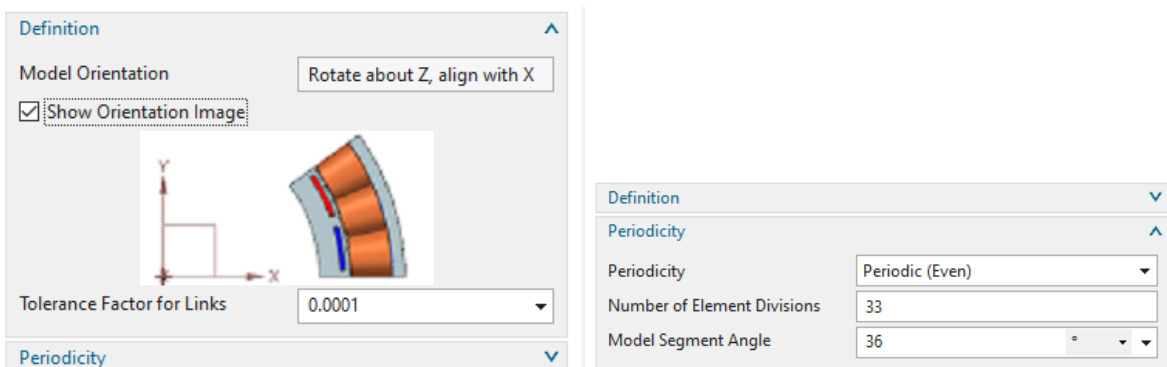

- The 'Tolerance Factor for Links' must sometimes be modified.

- It must be increased (use factor 10) if a message like the following appears in the solution monitor:
Warning : Could not find edge corresponding to reference edge ...
Error : Constraint Link: bad correspondance of number of edges ...
- It should be decreased, if this message appears:
Warning : Edge ... (...) already exists with tolerance ...

6. In box 'Periodicity' there must be chosen between periodic (even) and anti periodic (odd) conditions. The 'Number of Element Divisions' on the sliding surface as well as the 'Model Segment Angle' are defined here.

7. box 'Rotor' must be used to define the 'Moving Parts and Moving Air'.

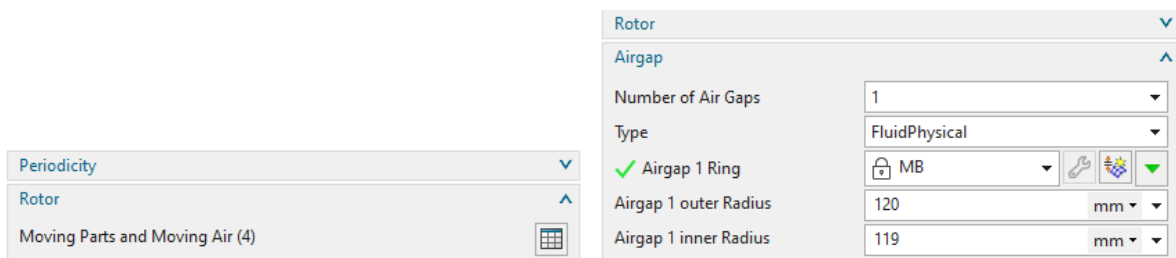

8. In box 'Airgap' the 'Number of Air Gaps' is defined as well as the Physicals of the 'Airgap 1 Ring'. Also the two radii are there defined.

9. Box 'Link Periodic Faces' must be used to define the four previously already meshed 2D dependent meshes on the rotor and the stator, master and slave sides. The naming here corresponds to the names we used in the previous text. Such 2D meshes must be assigned a physical of type 'BoundaryConditionSet'.

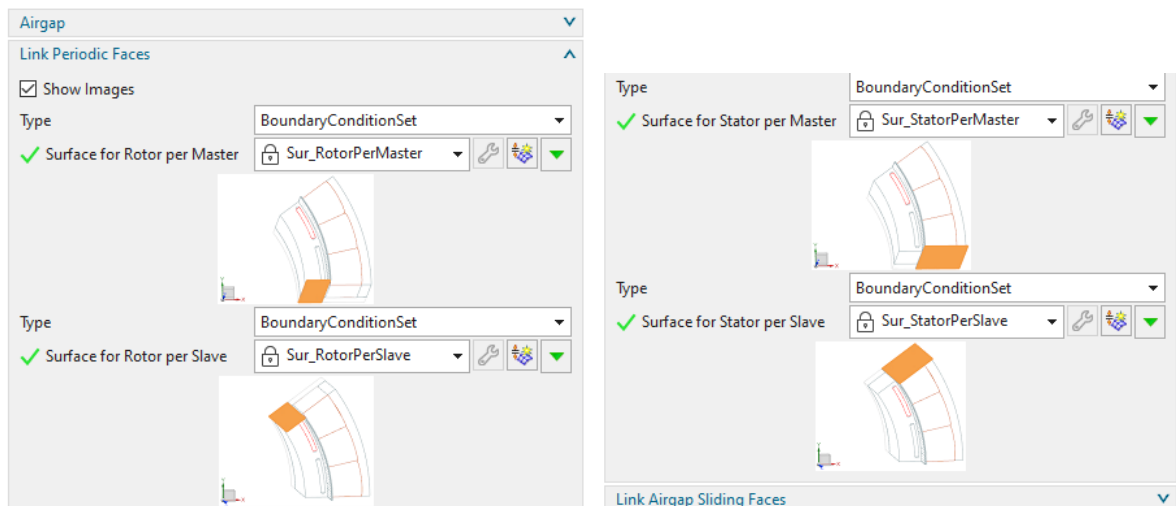

10. Box 'Link Airgap Sliding Faces' defines the two previously meshed sliding surfaces on the rotor and the stator. Also, the two lines 'Lin_SlidingSubmaster' and 'Lin_SlidingSubslave' are defined here.

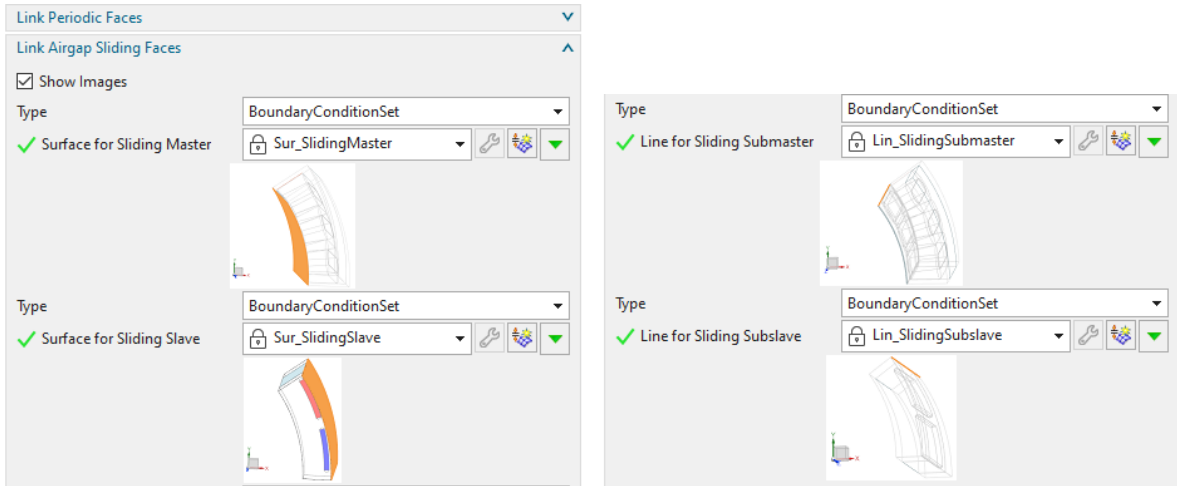

- Finally, the box 'Tree Lines' can be used to define the previously meshed main edges of the rotor and the stator. This selection is only necessary if the gauge type 'Tree, Cotree' is used (in case of sliding surface motion and linear material properties).

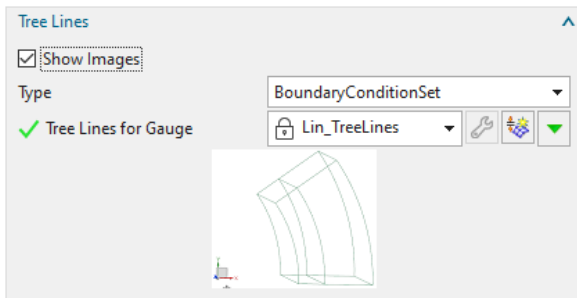

8.1.4 Recommendations for Meshing

We recommend the following process for the meshing of 3D motors with the sliding surface technique.

- Create the CAD model in the correct orientation.
- Include the air gap in the CAD model. For better accuracy of torque results, the air gap should be divided into three layers.

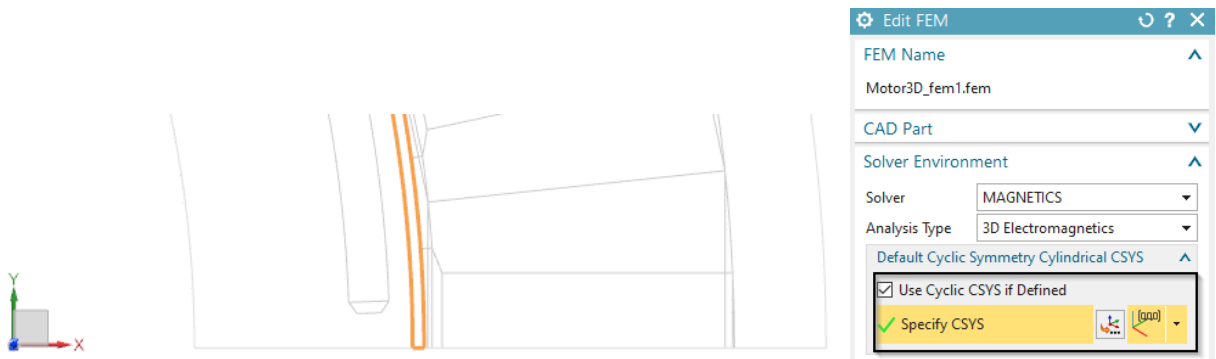

- In 'Edit FEM', set the 'Default Cyclic Symmetry Cylindrical CSYS' to absolute (see picture above, right). This allows the 2D dependent meshes to become more robust.

4. Start with the automatic creation of the Mesh Mating Conditions. First create all with option 'Glue Coincident'. Then locate those conditions at the sliding surface and set these to option 'Free Coincident'.
5. Then create the 2D dependent meshes at the two segment sections. Try as much as possible using the structured mesh option there. This is a bit sensitive, because the link constraints will not work, if these 2D dependent meshes are not accurately positioned. Put the meshes into mesh collectors. Assign names, as they are later referenced (Sur_RotorPerMaster, ...).
6. Then create the sliding surface mesh at the stator side (Sur_SlidingMaster). Use the '2D Mapped' mesh command for that. When defining the number of elements along the circular edge, keep this number for later use in the modeling object for the rotor definition.
7. Now create the 3D meshes at the air gap.
8. Next create all other 3D meshes. Easiest way is to use only tetrahedral elements, but also hex and pyramid transitions can be used.

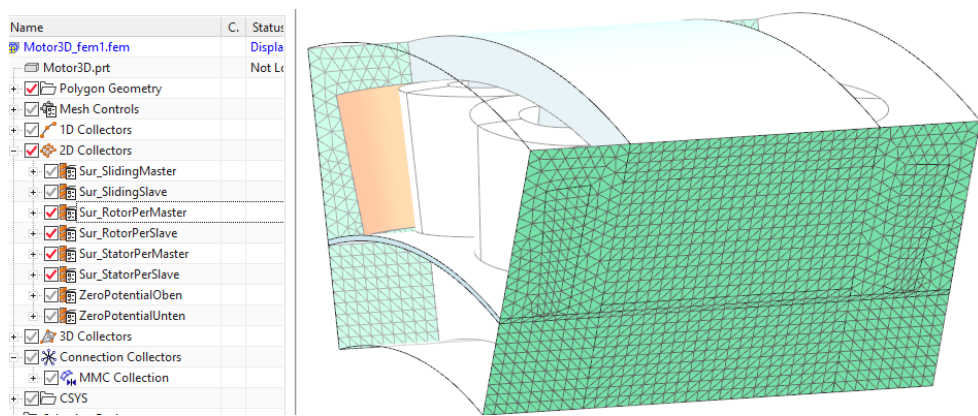

8.1.5 Solving and Post Processing

The remaining features in this model are not very special: Meshes, mesh mating conditions, materials, electric current loads, solution properties. Of course, the solve time for this 3D model is much higher than for the 2D case. Particular if there is nonlinear material included this is the case. We want to mention that also dynamic solutions are possible with this Sliding Motion feature. Results show either tabular graphs with torque, losses and others or plot results showing field results with time steps and motion. Following we present some result illustrations.

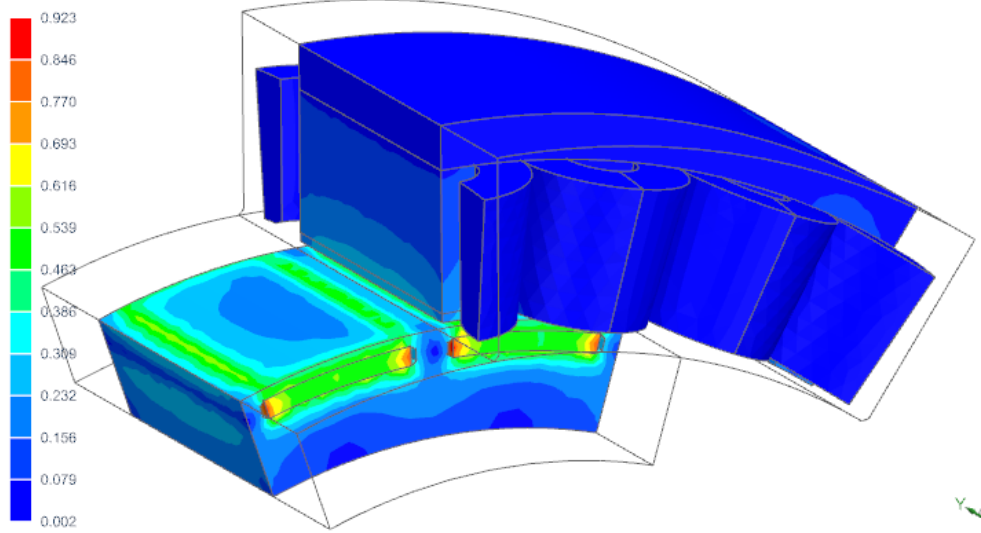

[7]

9 Tutorial 8

9.1 Motor Analysis in 3D by General Motion

In this tutorial we analyse a permanent magnet electric motor in 3D. For motion we use the General Motion technique. A Fem and Sim file are already created and in this exercise we walk through the existing model to check and explain the used features.

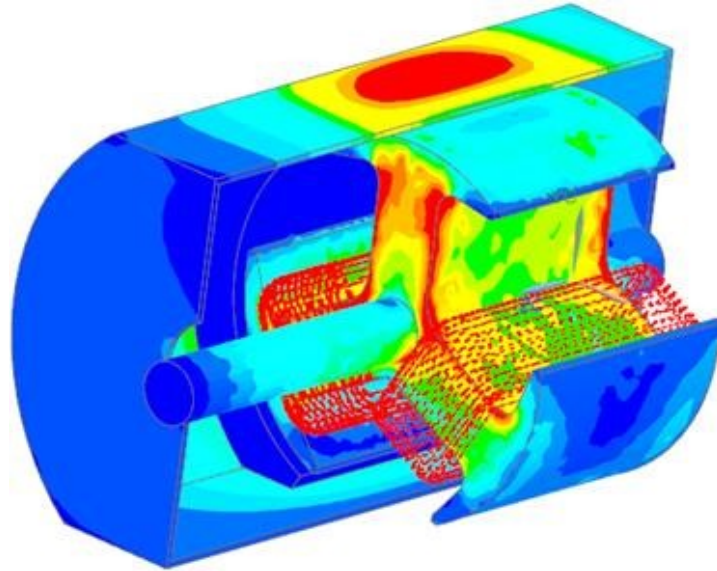

1. Download the model files for this tutorial from the following link:
<https://www.magnetics.de/downloads/Tutorials/6.CouplMotion/6.9Motor3DGenMot.zip>
2. Open in Simcenter the file 'Motor.prt'.
3. For checking this CAD file, use the modeling application. In the Part-Navigator deactivate the 'Time Stamp'. This setting allows to see the volumes and sheet bodies regardless of their creation history.

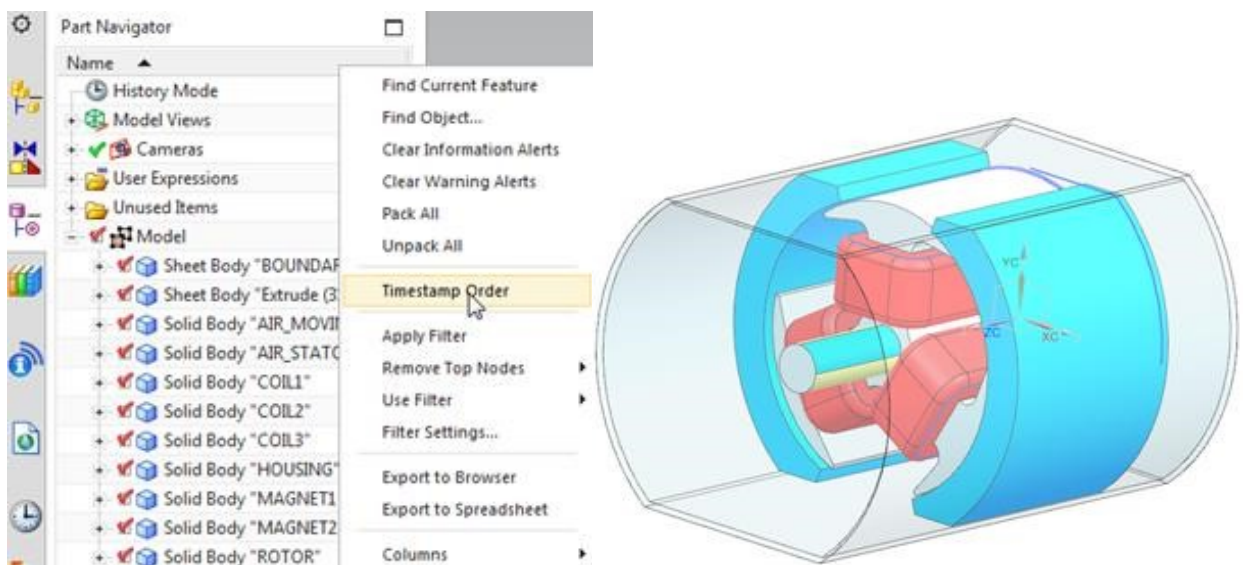

- For the General Motion feature there must be a separation between moving and stationary parts. All nodes that belong to the moving parts will be rotated during the analysis process. The area between moving and stationary parts will be meshed newly at every time step. To keep this process efficient one should try to only have a small area for that mesh update. In many cases – and also in this example – a small air gap around the moving parts can be used for the mesh update. When sectioning the view the air gap that surrounds the rotor can be seen.

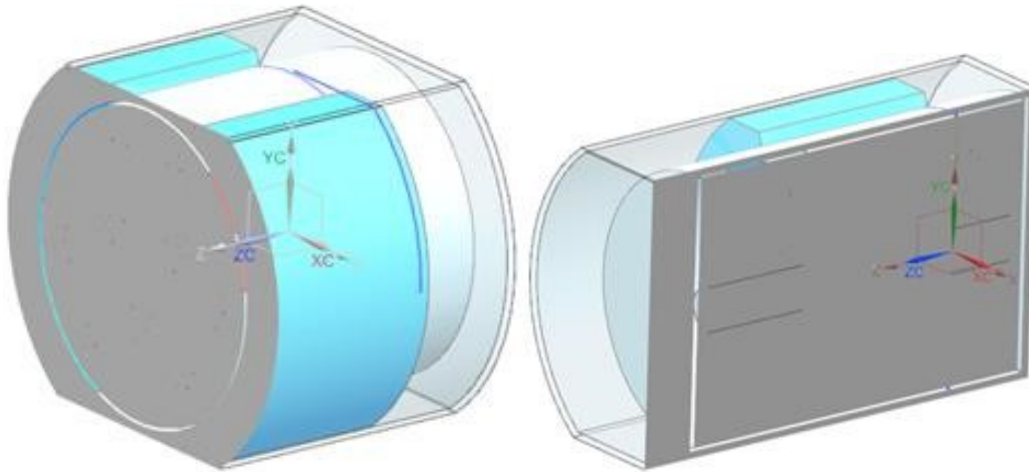

- Open the Fem file Motor_fem1.fem. All meshes are very coarse. Let's check the meshes that reside in the file.
- First check the Rotor mesh and the three coil meshes. There is nothing very special here.

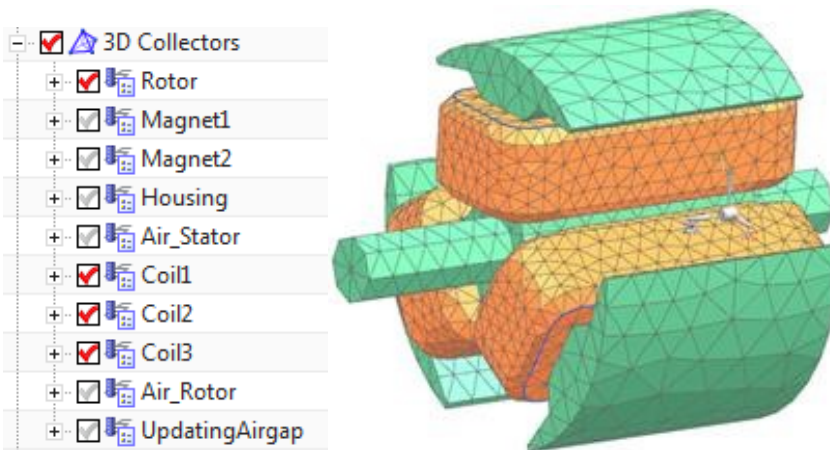

- Next check the 'Air_Rotor' mesh. This mesh represents the rotating part of air. All rotating meshes are referenced in the Sim file by the Simulation Object 'Enforced Revolute by General Motion'.

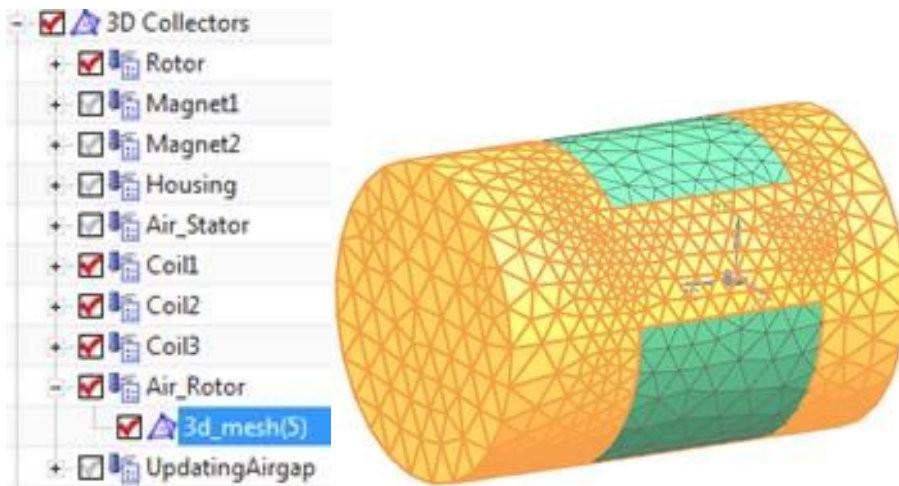

8. Around these rotating parts there is the updating gap (picture below). That gap is bounded by 2D meshes. When solving, the system will automatically create and update that gap mesh using a 'Solid from Shell Mesh' type mesh. This mesh will update with each time step. The boundary meshes reside in two mesh collectors: 'UpdatingAirGapBoundaryOutside' and 'UpdatingAirGapBoundaryInside'. The number and names of these boundary meshes can vary as needed.

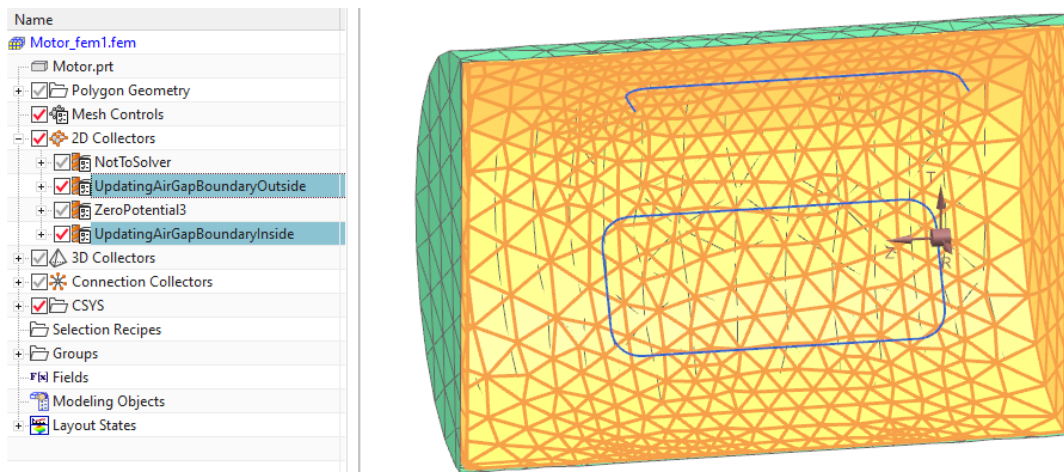

9. Notice the 3D mesh collector 'UpdatingAirgap'. Edit and open the box 'Auto Mesh' and see that this collector has activated 'Auto Mesh at Solve'. In 'Shell Boundary for 3D Mesh' there are the two Physicals of the boundary meshes selected. That way, the air gap mesh will be recreated at each solve step.

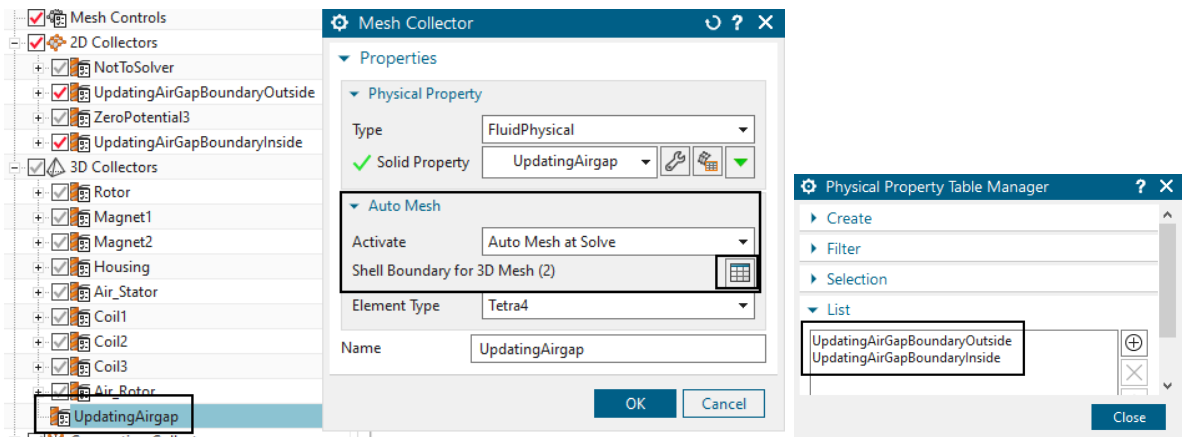

10. Next look at the magnets. They use cylindrical coordinate systems and point in opposing directions.

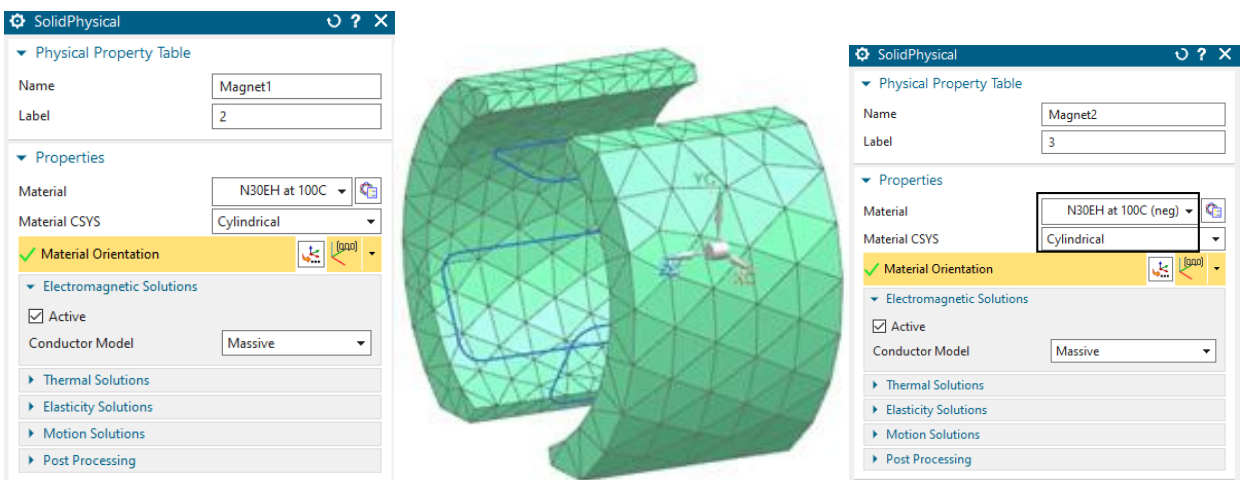

11. And check the housing, a thin walled metal geometry.

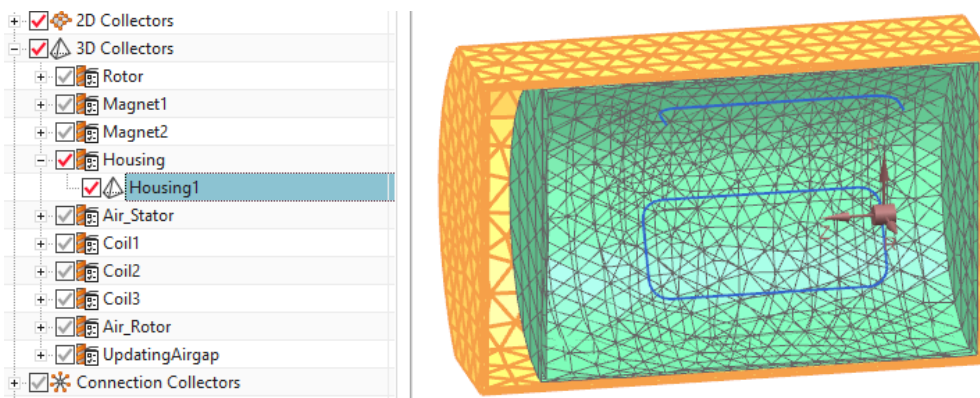

12. The Air_Stator mesh collector represents those air parts that do not move. This is made by two 3D-meshes.

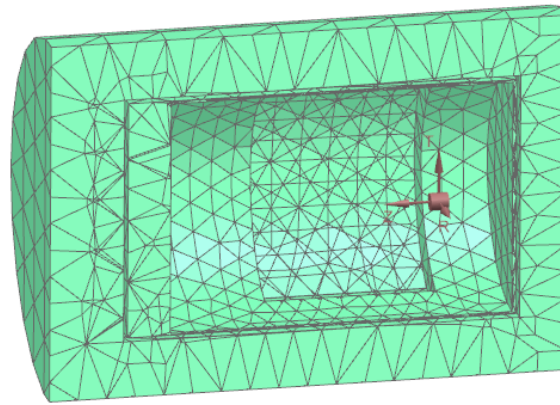
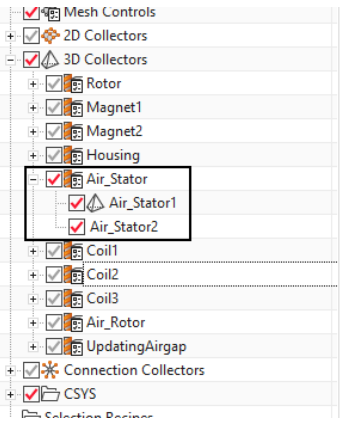

13. One of the above two Air_Stator meshes is created by the function '3D Mesh from Shells' and the used shells are shown here: One shell mesh uses a simple 'Not to Solver' Physical and the other a 'Zero Potential'.

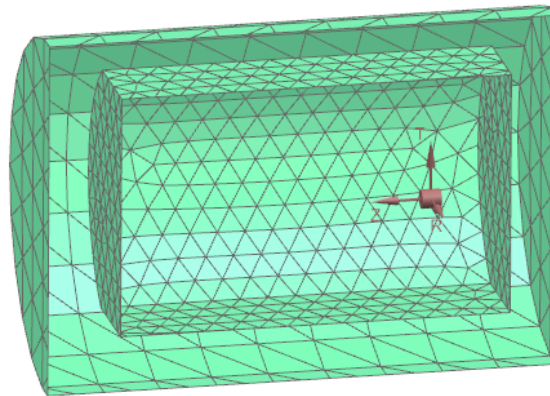
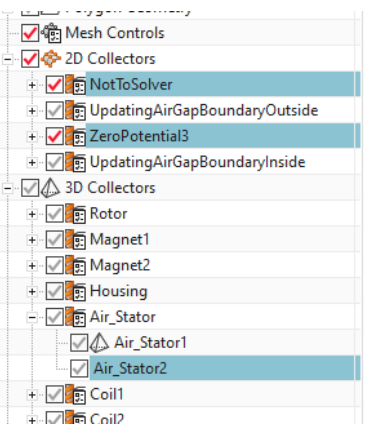

14. Change to the Sim file now.
15. We use a Magnetostatic solution type. Magnetodynamic transient is possible also.
16. See the Enforced Revolute joint feature: We rotate about Z and Angular Velocity set to 1 rev per min.

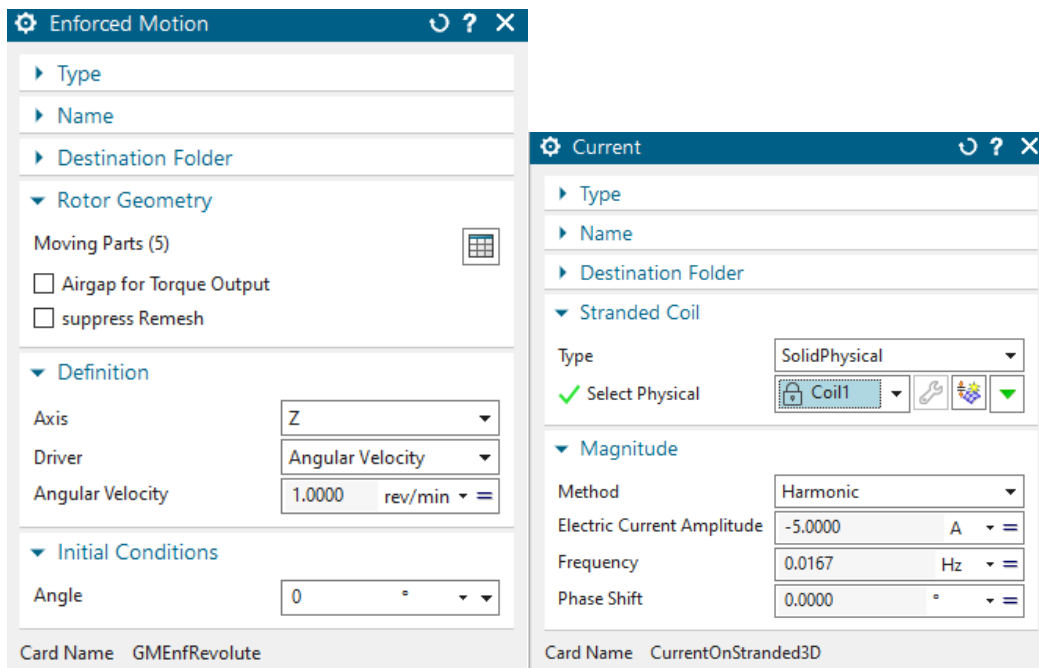

17. All currents are set to harmonic as shown above for coil 1. You can change these conditions to your needs.
18. Solve the solution for as many steps as you desire.
19. Postprocess your results.

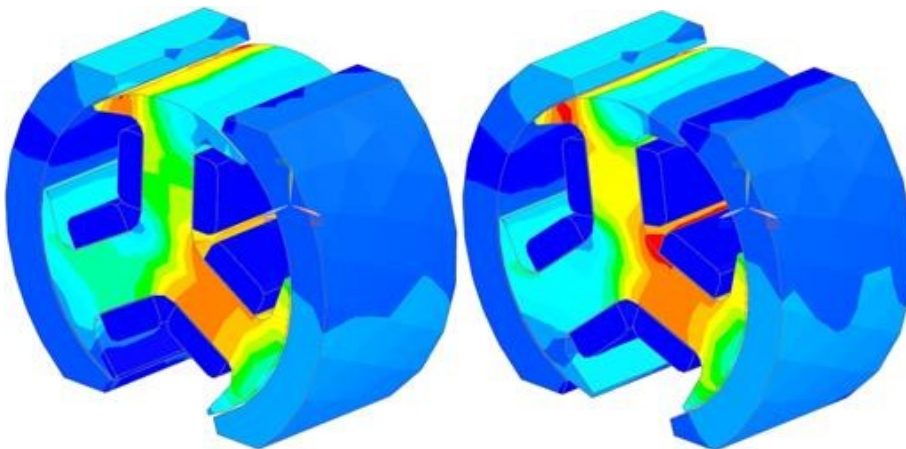

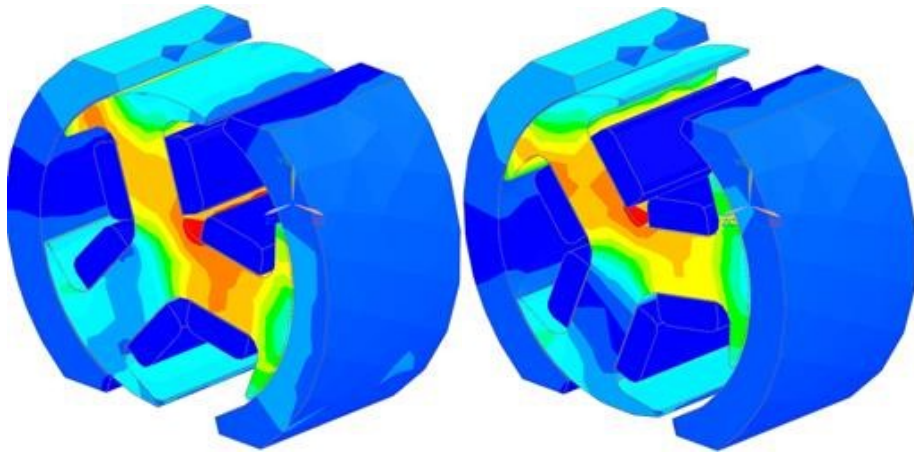

10 Tutorial 9

10.1 Electric Motor Analysis for NVH

Vibration and noise from in runner electric motors comes mainly from the stator deformation, induced by the constantly varying magnetic field activating individual phases. The deformation on the outer surface of the motor causes the air around it to move, generating pressure differences, which are perceived as noise for the human ear. There are three disciplines to be considered in this analysis—magnetic, vibrational (structural), and acoustic [SantosAnthonis-NaclerioGyselinck].

In this tutorial we analyze a servo motor for the magnetic and vibrational (structural) disciplines using MAGNETICS for NX and NX NASTRAN. For the third part, acoustics, NX NASTRAN can also be used, but we will not show it here because we focus on the magnetic part.



Picture: Siemens 1FT6 Servomotor

The results base on magnetic forces on the teeth. For this we will first perform a transient analysis in 2D and compute forces on the teeth. We will use a postprocessing solver feature that converts the time dependent forces into frequency dependent ones using Fourier transformation. Then those frequency forces will be imported into NX10 using the feature load recipe that is new in NX10. Finally in NX a frequency response analysis in NX NASTRAN Solution 111 with those forces as input will be performed.

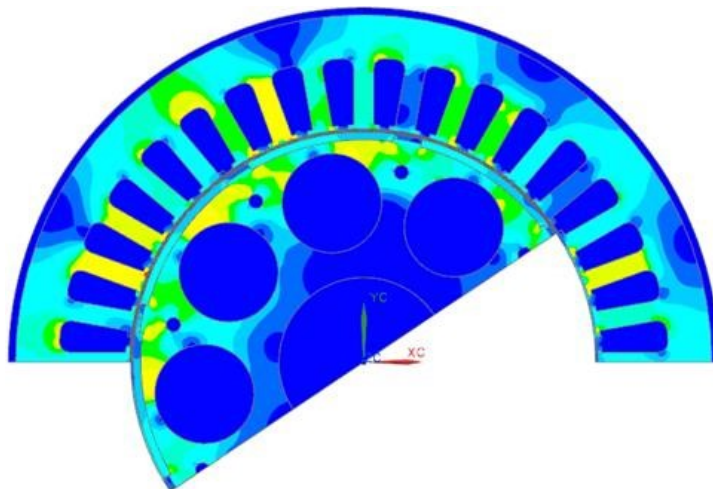

Picture: Complete Simulation Model of 1FT6 Motor. Fluxdensity distribution in 1FT6 Servomotor. Two out of four poles are modeled using periodicity conditions.

Starting point is an already complete simulation model of a servo motor. We first check it and then add the necessary steps for NVH export and solve in NX NASTRAN.

1. Download the model files for this tutorial from the following link:
<https://www.magnetics.de/downloads/Tutorials/6.CouplMotion/6.8MotorNVH.zip>
2. Open the part Motor1FT6_sim1.sim.
3. Change to the FEM file and notice the following features that are specific for NVH export:
 - This motor has a total of four poles and is modeled using two poles. There are 18 teeth in the model on which we want to analyze for forces.
 - Notice there are faces under all teeth. The next picture shows the face under the second tooth. These faces are defined in CAD by subdivisions of the neighboring faces of the air gap.



- Each of these tooth faces has its own physical. The numbers of them start at 101 and then count up to 118.
- The thickness of these gaps is 0.43 mm as you see in the next picture.



4. Change to the SIM file
5. Notice there already exists a magnetostatic solution with all loads and BCs already given. If you want solve this solution for checking, but there is nothing very special to learn from. The torque should vary between about 18-20 Nm.
6. Create a new solution of type 'Magnetodynamic Transient'.
 - At Output Requests under 'NVH Coupling' activate the switch 'NVH Motor Export' (also activate Motion Data under Tables). Key in the first and last physical ID of your tooth faces at 'NVH Start PID' and 'NVH End PID'. Also key in the Gap Thickness to 0.43mm.

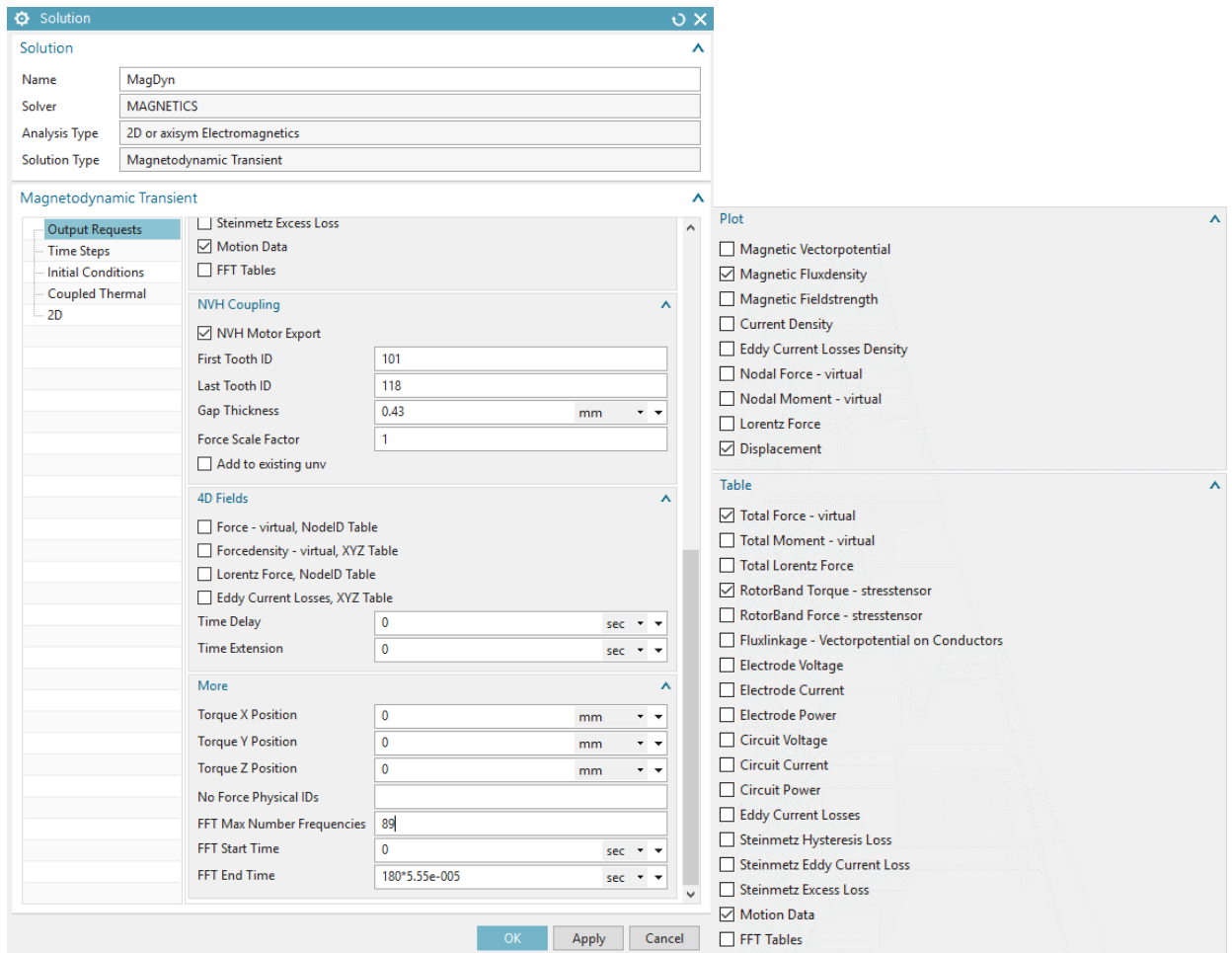

Set all other settings as follows:

- Time Steps: 180 steps will result in one electric period.

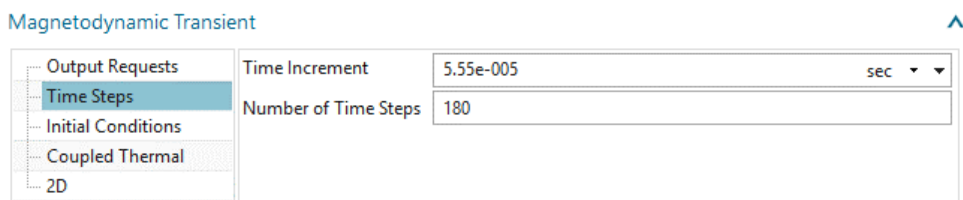

- 2D:

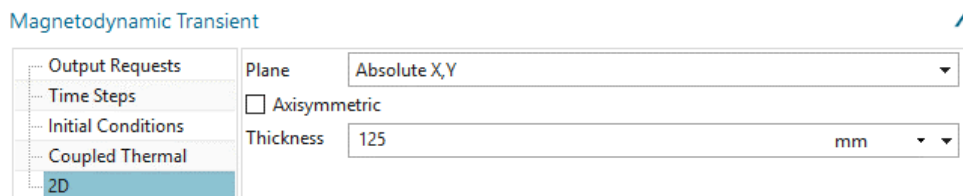

- In Solver Parameters under 'Numeric' set 'Epsilon' for better precision as shown:

Parameters

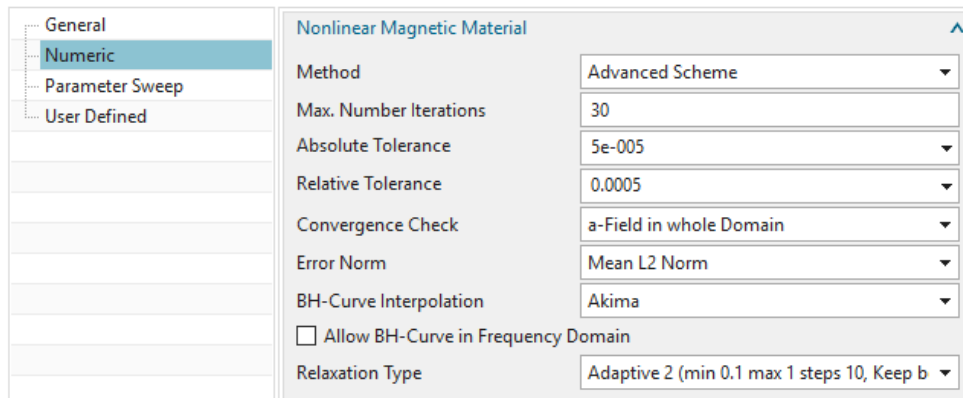

7. Put all existing loads, constraints and simulation objects into the new solution.
8. Solve the dynamic solution. This will take about 2-5 min.
9. Notice that after the solve process a couple of text files have been created.
 - As a first check, switch to the 'XY-Function Navigator' and plot the Torque results of the joint (in case that the .afu files are not already loaded, reload them); said results should lie (roughly) around 18 Nm.

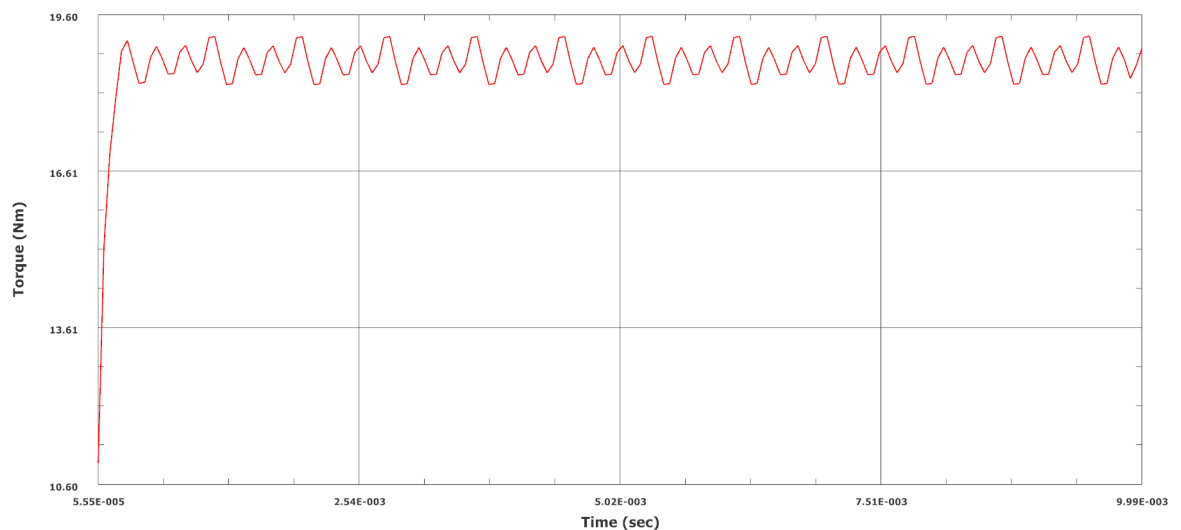

- In addition the files '`..._NVH_ForceRad.txt`' and '`..._NVH_ForceTan.txt`' were created; these files contain the tangential and normal forces on all 18 teeth for each time step (time domain).
- To create the associated .afu files, use the function 'Table-Result to AFU Graph' and select the above mentioned .txt files.

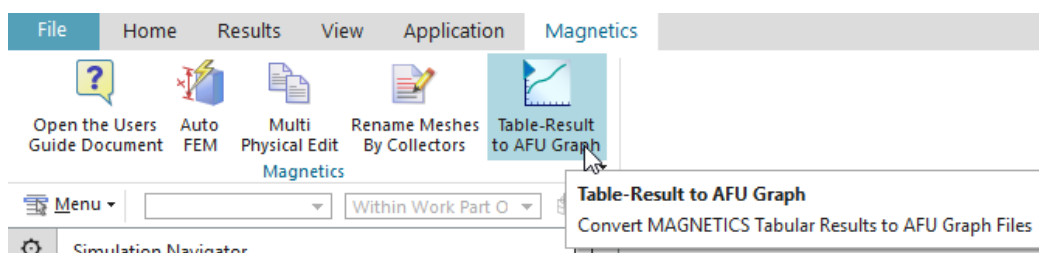

- In the XY-Function Navigator, press 'Open', to load the newly created .afu files.

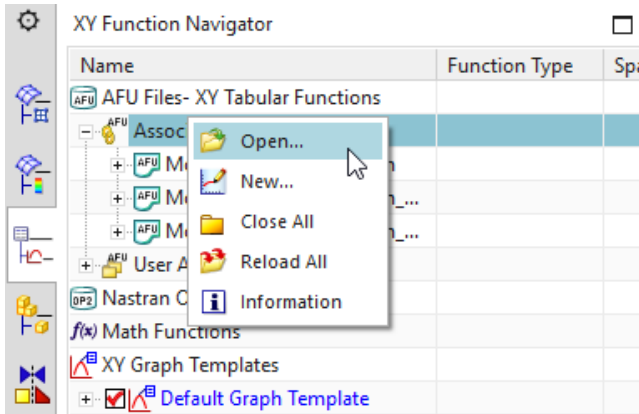

- Then, plot the radial and tangential Forces of tooth 101

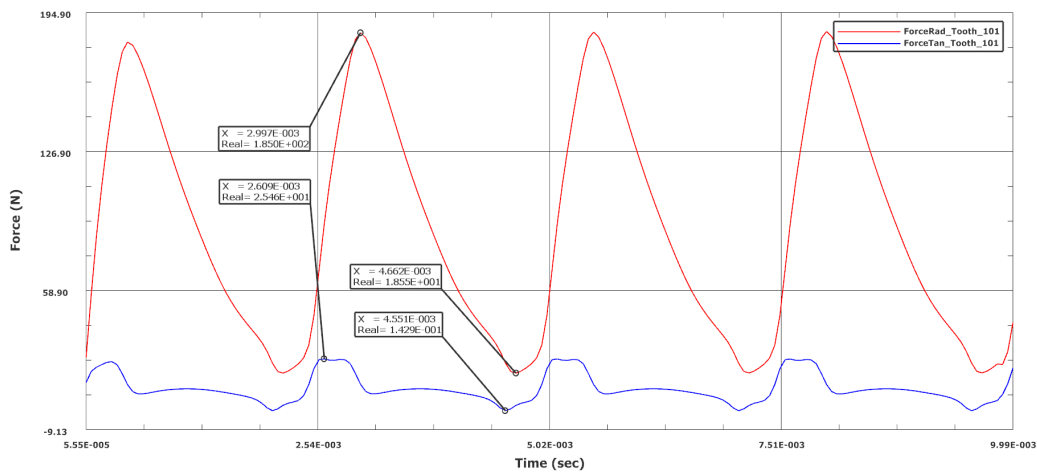

These forces are computed by the following equations based on the Maxwell Stress tensor that is evaluated on the previously defined teeth faces:

$$f_t = v(B_n B_t) dl$$

$$f_n = \frac{1}{2} v (B_n^2 - B_t^2) dl$$

with:

f_n, f_t : Radial and tangential force

$v : 1/\mu_0$.

B_n, B_t : Radial and tangential magnetic fluxdensity

- '..._NVH.txt': This file is generated at the end of the run. It contains the Fourier transformed forces on the 18 faces. For each frequency (column 1) the amplitude (Column 2) and phase (column 3) are written.

Some background on the method: You need to postprocess a time evolution with the help of a Fourier Transformation, in order to obtain the Frequency spectrum (that is e.g. required by NASTRAN 111 as input). Simplified (i.e. without oversampling) Nyquist's theorem states that If there are N time steps over this period (so N+1 points) then a maximum of N/2-1 frequencies will be obtained, where N is the Nyquist frequency. In our example, there are 180 time steps and we obtain 89 frequencies.

```

Motor1FT6_sim1-MagDyn_NVH.txt
1 ForceTan on 101
2 0 10.85754439908529 0
3 100.1001001001001 0.5109283383378073 0.04114257883124724
4 200.2002002002002 0.5046303137190914 0.1072966894853234
5 300.3003003003003 0.4919625875184704 0.1718146680351747
6 400.4004004004004 5.868126078333566 -1.11200430440846
7 500.5005005005005 0.4973035276757329 0.2211725640997294
8 600.6006006006006 0.4814235295587715 0.2714188739542077
9 700.7007007007007 0.4697348119215426 0.3102080459887557
10 800.8008008008008 6.260014500659615 -1.023974647448176
11 900.9009009009009 0.4413730559054543 0.3899204565605453
12 1001.001001001001 0.4306148613243748 0.417127511784962

```

- '..._NVH.unv': This file also contains the frequency domain forces, but it is formatted in unv format using dataset 58 what is capable for LMS Virtual Lab and NX10 Load Recipes. We are going to read it into NX to perform a NX NASTRAN dynamic response analysis.

```

Motor1FT6_sim1-MagDyn_NVH.unv
18 58
19 101:+z
20 Magnetics for NX
21 Empty
22 Empty
23 1
24 12 1 1 0 ForceTan 101 2 NONE 0 0
25 6 90 1 0.00000e+00 1.00100e+002 0.00000e+00
26 18 0 0 0 NONE Hz
27 13 0 0 0 NONE N
28 0 0 0 0 NONE NONE
29 19 0 0 0 NONE RPM
30 1.085754439909e+001 0.000000000000e+000 5.104959721204e-001 2.101497954887e-002
31 5.017283011388e-001 5.404133011488e-002 4.847189965500e-001 8.411112828555e-002
32 2.598789838416e+000 -5.261292146134e+000 4.851896564829e-001 1.090953522418e-001
33 4.637993209057e-001 1.290689921717e-001 4.473144083603e-001 1.433897262857e-001
34 3.255051022317e+000 -5.347188456617e+000 4.082432846731e-001 1.677724500586e-001
35 3.936924182063e-001 1.744575554119e-001 3.795882542144e-001 1.793262824941e-001
36 4.904525536089e-001 -3.185969504131e+000 3.456357676949e-001 1.870632222918e-001

```

- Some information about the .unv file, see prior picture: The numbers 101 and 2 in line 24 define the source-function 101 and the direction 2. In line 25 you find 0.00000e+00 as the first frequency and 1.00100e+002 as the frequency step. Starting in line 30 there are couples of complex numbers, e.g. real part followed by their imaginary part.

10. Save your files and close them.

11. Open in NX10 or a later version the existing Sim file 'Motor1FT6_assyfem1_sim1.sim'. This model is already mostly build up for the NASTRAN NVH structural analysis.

12. Notice the following features in the model:

- It is set up as an assembly fem. E.g. only one tooth is meshed in a FEM file called 'Motor1FT6_fem2.fem' and this mesh is placed in an assembly 36 times. The thickness (z-direction) is set to only 1/6 of the real 125 mm because we are not interested in z direction vibration effects.

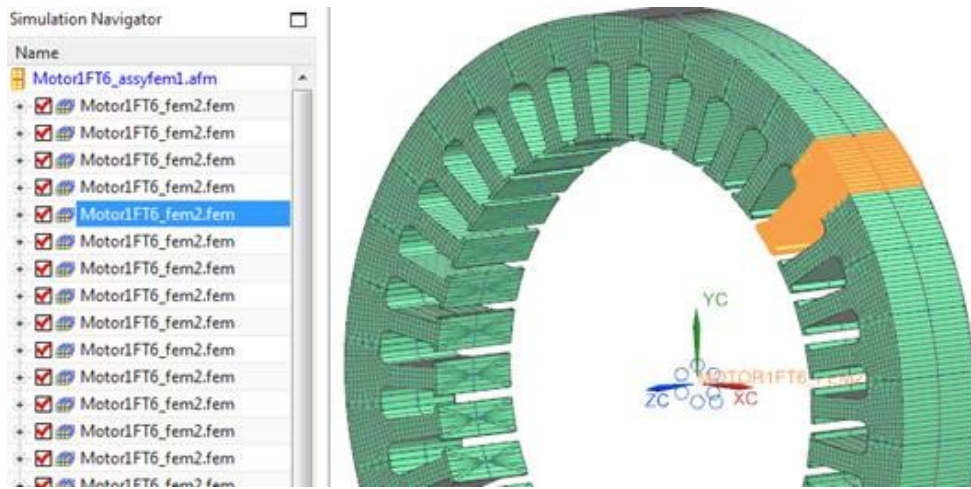

- The nodes are merged in the assembly fem. Another possibility would be to use glue conditions in the SIM file.

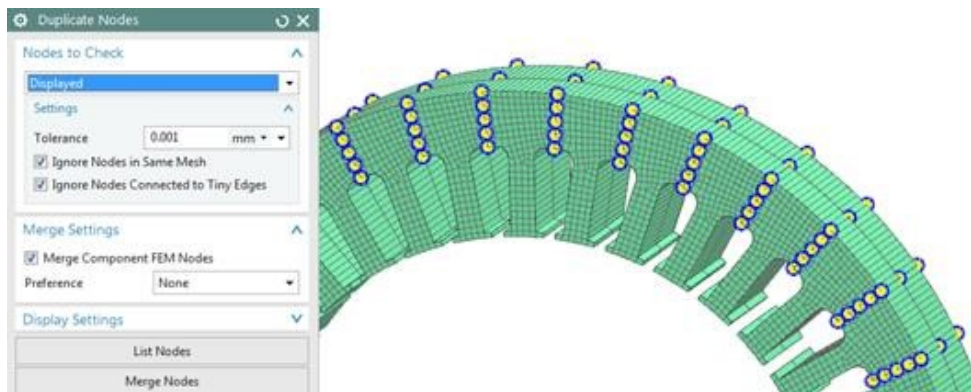

- In the piece FEM file 'Motor1FT6_fem2.fem' there is a 1D Connection defined that connects the nodes that belong to the force face with a point in the middle. This node will be used in the SIM file to apply forces on.

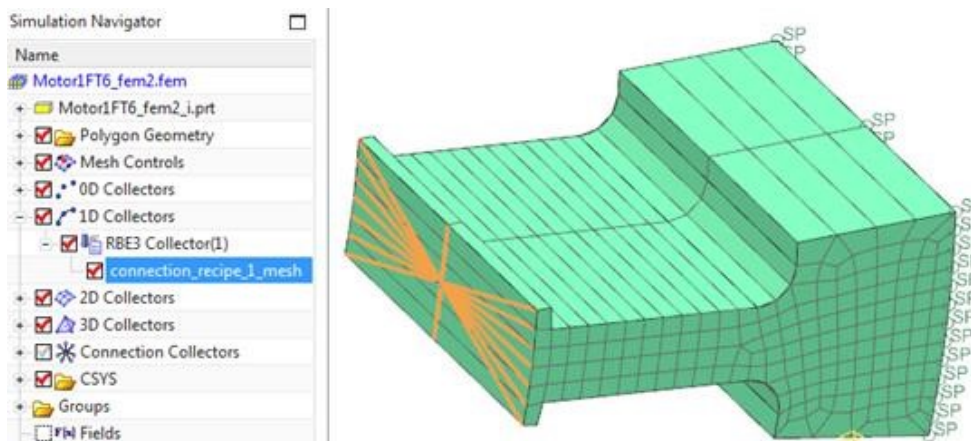

- There is a Cartesian nodal coordinate system assigned to the force node. (This can be done with 'Edit, Node, Assign Nodal Coordinate System ...'). X points into the radial and y to the tangential direction. Later in the assembly mesh there will be such coordinate systems for each tooth. If we apply forces on the teeth they will use these coordinate systems.

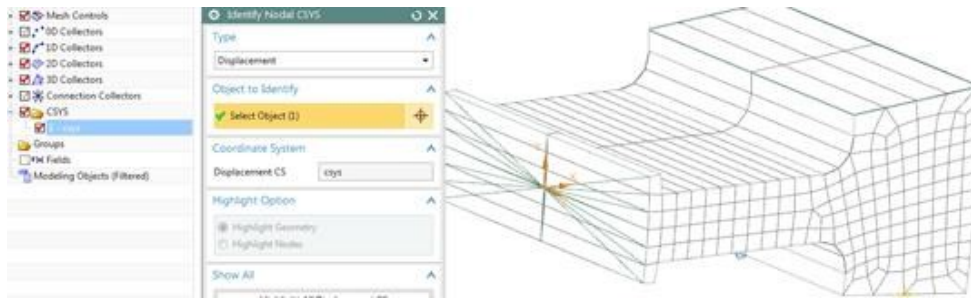

- There are bushing elements of grounded type (0-D Mesh: CBUSH Grounded) connected to the outside face nodes of the tooth. These bushings are quite weakly defined and serve as boundary conditions.

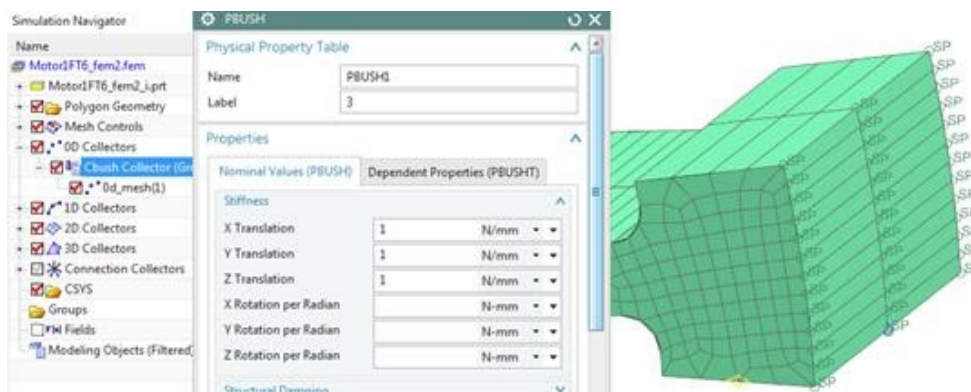

Correction: Set

the stiffness values to 10 N/mm.

- In the assembly fem file there are 18 groups defined on which we will later apply the forces. In the case of this motor we have a symmetry factor of 2 for the electromagnetic analysis, e.g. we had to analyze the half. So for the structural analysis all teeth forces must be applied to 2 teeth faces or their corresponding nodes. In case of other symmetry factors this must be considered similar. For easier selection those two nodes are put into a groups. So we have 18 groups each with 2 nodes. The next picture shows as an example two teeth (number 2 and 19) that must have the same forces:

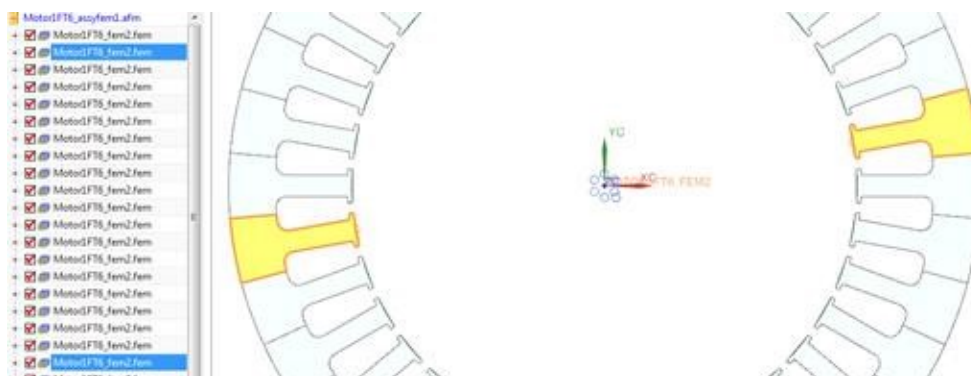

- Consequently the two forces nodes of tooth 2 and 19 are put into one group. This can be seen in the next picture:

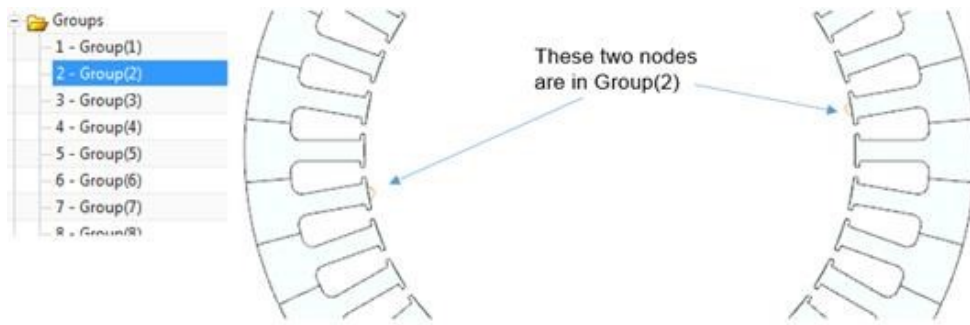

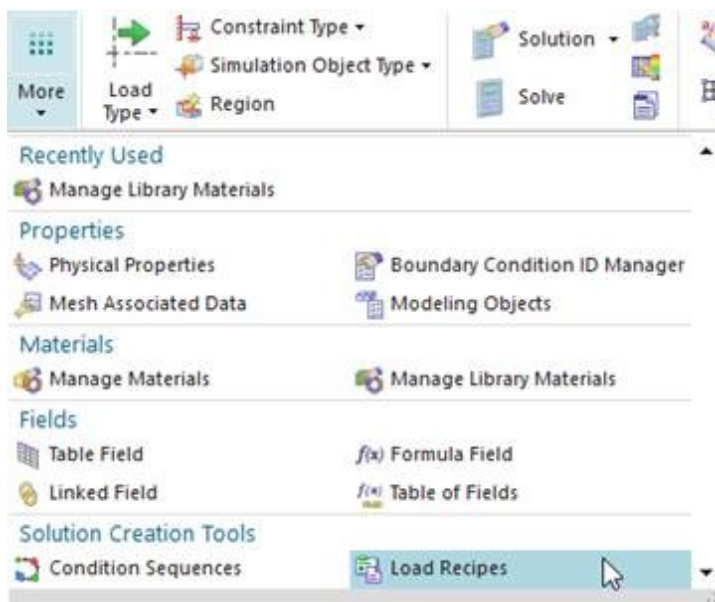

13. Change to the Sim file. Next you will create a load recipe that references the frequency dependent force information in the .unv file and that applies those forces respectively to the corresponding node groups.

- Choose the function 'Load Recipes',

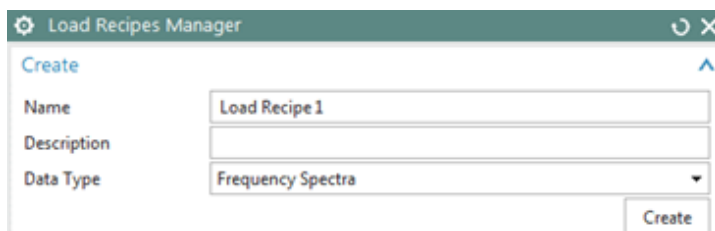

- Set the 'Data Type' to 'Frequency Spectra' and click 'Create'.



- In register 'Data Source' press 'Browse for a new data source'  and select the newly created unv file.

- Press 'Automatically populate the mapping table and ...' .

- Set the register to 'Mapping'. You can see on the left that the system has found forces on nodes in the file.

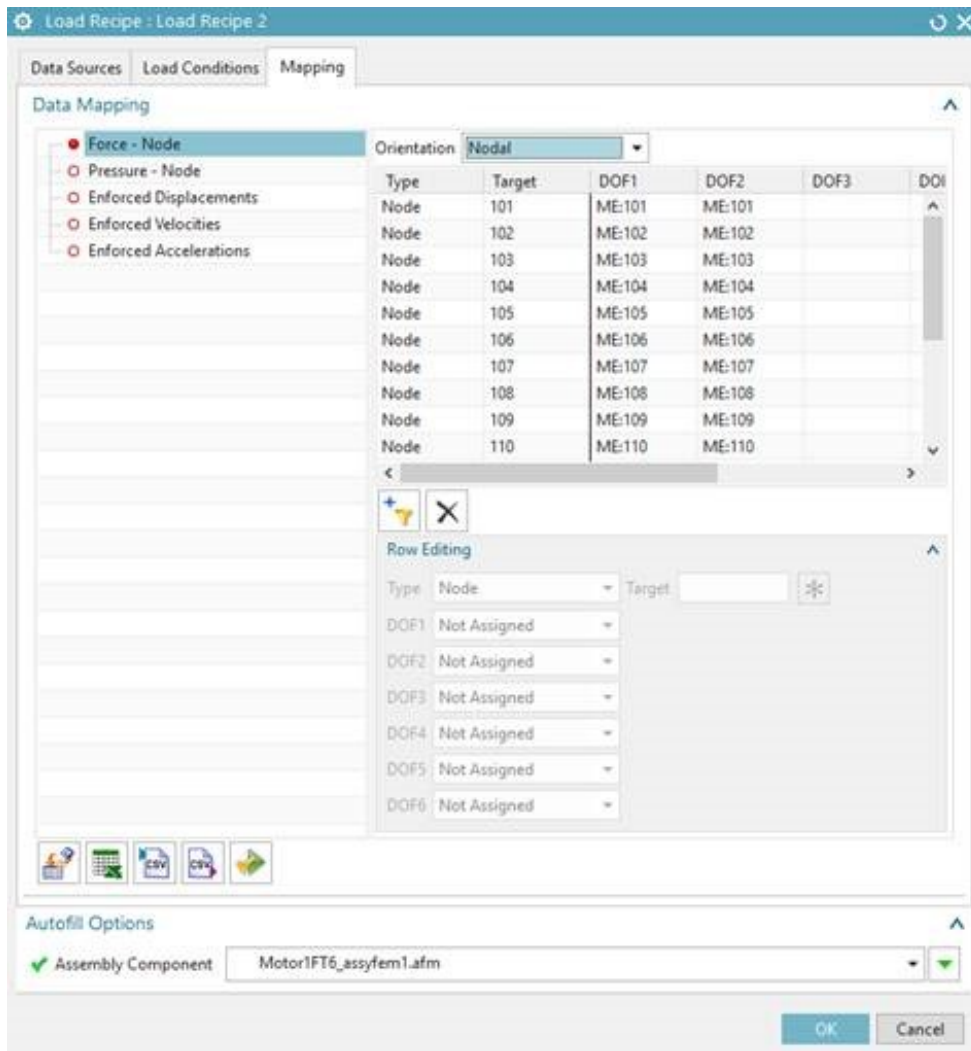

- On the right side you see the mappings of the found forces to FE entities. First thing you should do is set the 'Orientation' option to 'Nodal'. This will result in the use of our nodal coordinate systems.

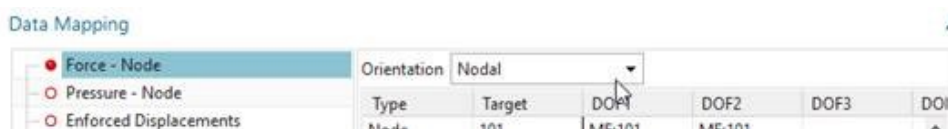

- In column 'Target' you see the source-functions that are found in the .unv file. These source-functions correspond to the computed forces on the 18 tooth faces computed in MAGNETICS. You will now assign those source-functions to the prepared node groups.
- Click on the first line (Target 101). In the lower area of the dialogue set 'Type' to 'Group' and press  to change the target for this source-function.

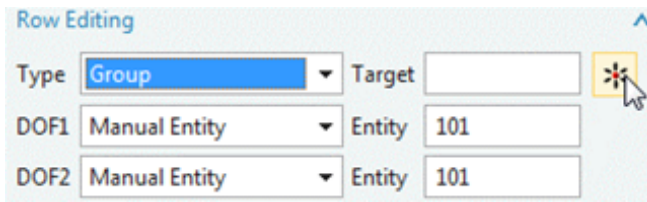

- In the next dialogue select the group Group(1) and Ok. The dialogue now shows that node group Group(1) will be applied by source-function 101 in the DOF1 (e.g. the radial) and DOF2 (the tangential direction).

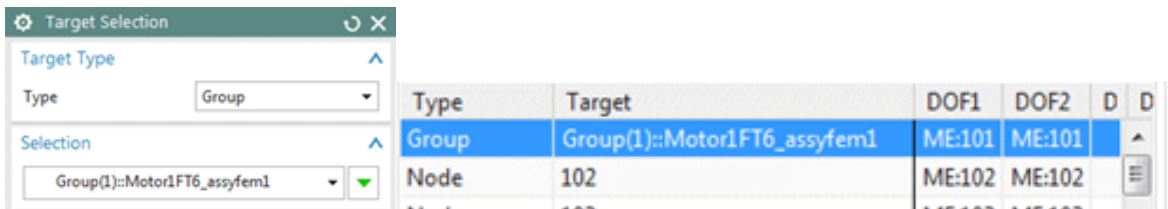

- Repeat the last two steps for all 18 source-functions. At the end the dialogue should look like in the following picture. Maybe you want to run the validation check finally



Press ok and close then.

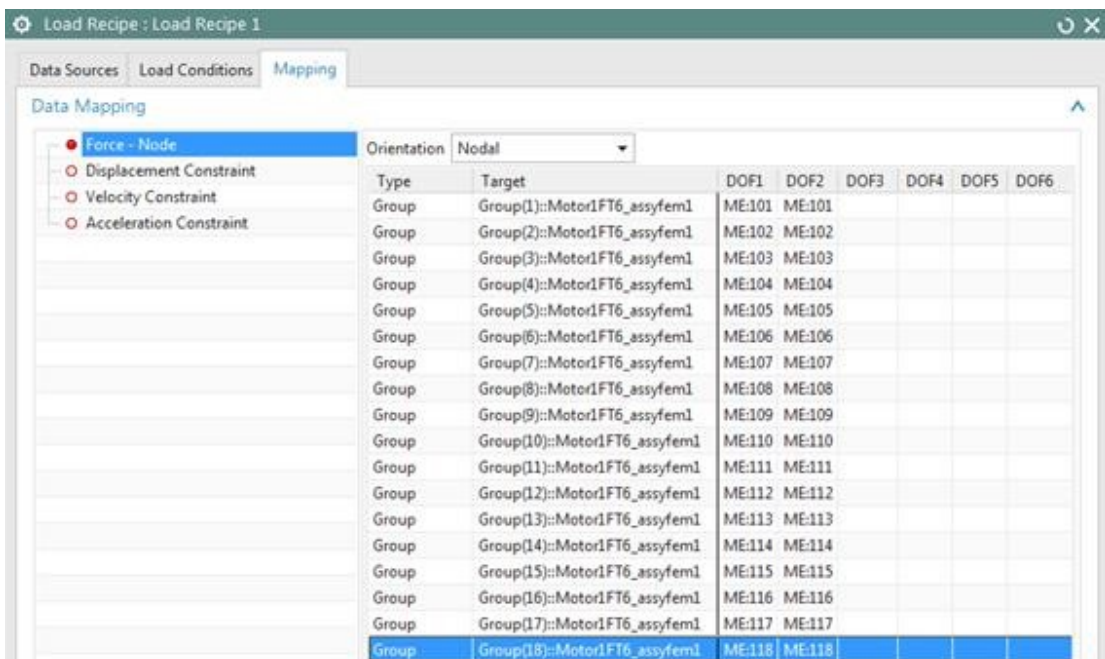

14. Now create a solution by RMB on the SIM file and 'New Solution From Load Recipe...'. .

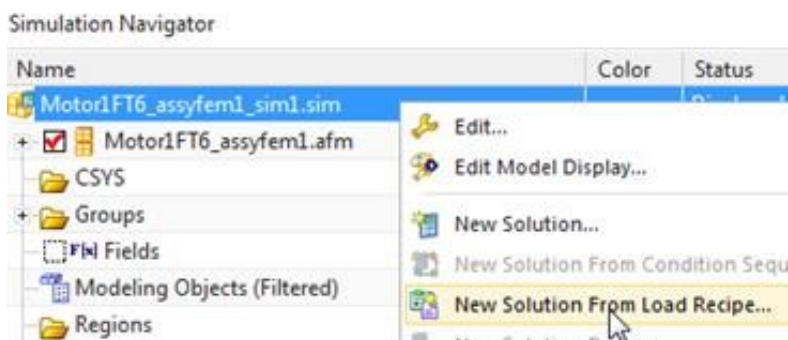

15. Choose the Solution 111. In this case we will accept all default settings, so press Ok and the solution is created.

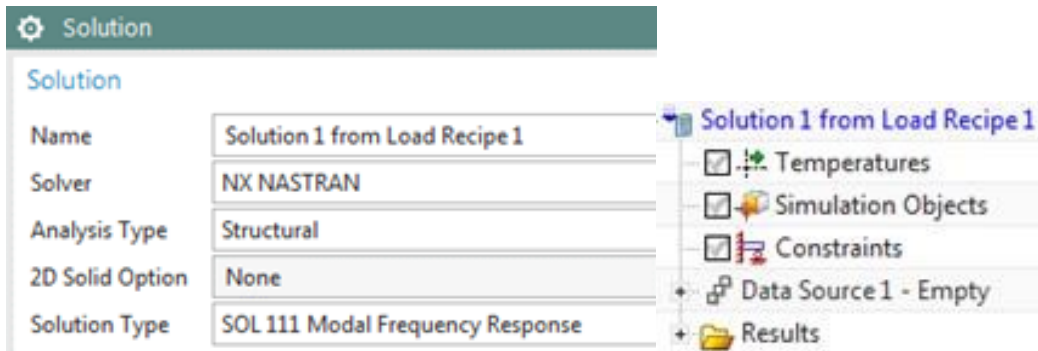

16. You can check every single force and the corresponding frequency domain data. In the subcase 'Data Source1' there are all forces shown. The next picture shows radial (DOF1) and tangential (DOF2) forces on node 10224. Use RMB and 'Edit' to find the corresponding table data for this force.

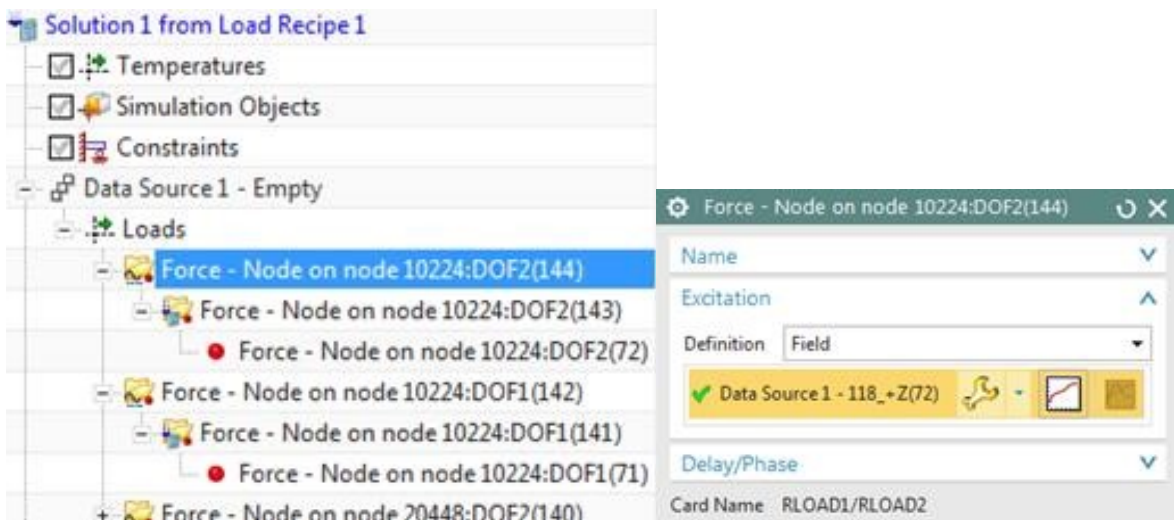

17. Use  to see the table, e.g. the amplitude and phase data as seen in next picture.

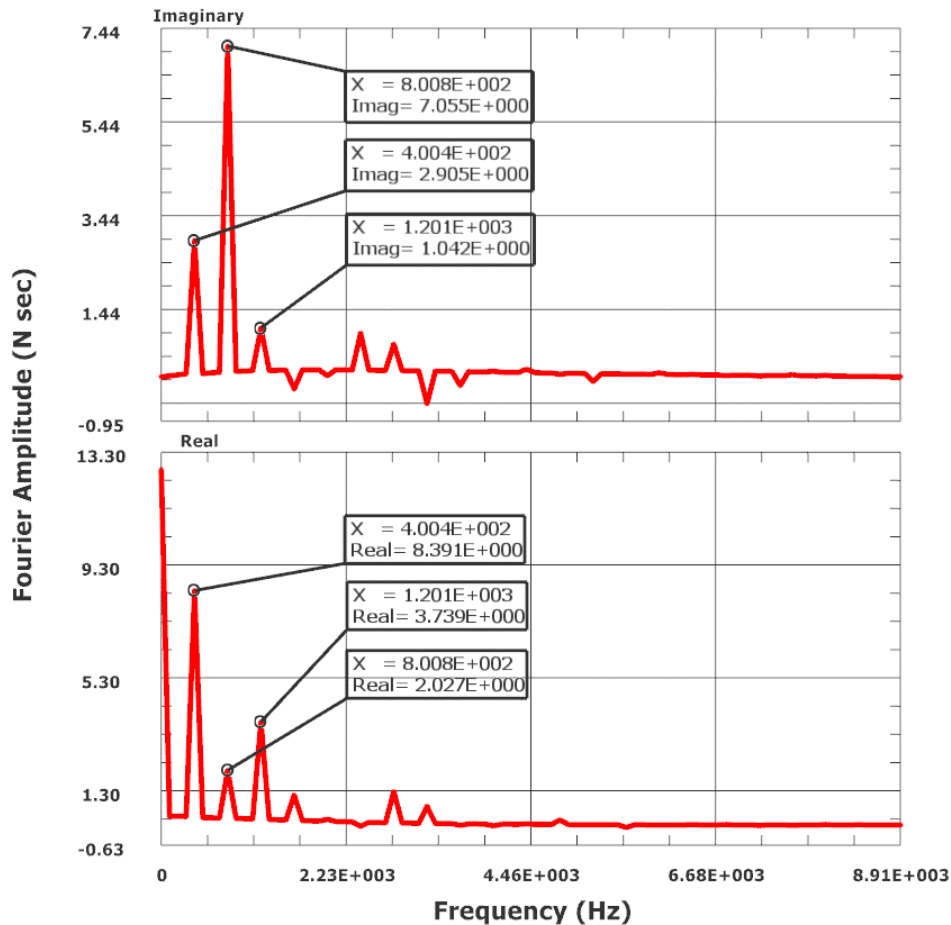

18. Activate the Source, by clicking RMB on 'Data Source..', 'Make Active'



19. We want to define the forcing frequencies, so choose RMB on 'Data Source' then 'Edit' and press 'Create Forcing Frequencies' . In the next window press 'Create'.

20. Choose the 'Frequency List Form' 'FREQ1' and key in as in the next picture. We use the same frequencies as they come out of the Fourier transformation of the electromagnetic tooth forces. But it is enough to check only for the lower frequencies, so we set the number to 15.

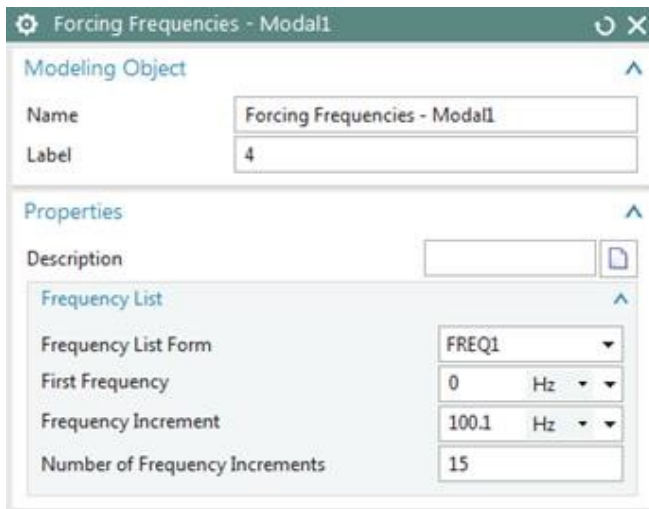

21. Press Ok and in the next dialogue click 'Add' and then 'Close' and 'Ok'.
22. If you want check the information in 'Data Source': There are fields and loads on all 36 nodes in the two directions.
23. Solve the solution.
24. Postprocess the results.
25. Create animations: The computed results are in frequency domain. So all results are in real and imaginary part or in amplitude/phase. To see an animation of the shape how it would look like in the time domain we need to cycle about the phase. This can be done as follows:
 - Open the displacement result of one of the frequencies in the postprocessor.
 - Open the displacement result of frequency 2 which is at 200.2 Hz as we have applied it.
 - Use 'Set Result' to set the result. Set the 'Complex' option to 'At Phase Angle'. Ok.
 - Set the factor for 'Deformation' to a absolute value, for instance 100.
 - Use 'Animate' and set the 'Style' to 'Modal'. Ok. The animation for this frequency is shown. From here you can manually extract the maximal deformation (in this case 0.0063mm).

Motor1FT6_assyfem1_sim1 : Solution 1 from Load Recipe 1 Result
 Data Source 1 - Empty, Forcing Frequency 3, 200.2 Hz
 Displacement - Nodal, Magnitude
 Complex Option : At Phase Angle 0.0
 Min : 0.00272409, Max : 0.00633229, Units = mm
 Deformation : Displacement - Nodal Magnitude, Complex Option : Amplitude

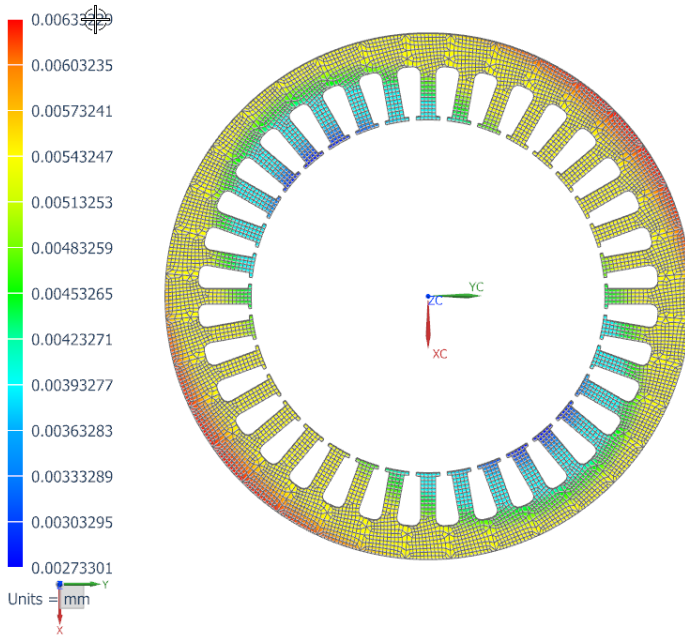

- Use the green buttons to cycle through the frequency results.

26. For validation of the computed results we show a table with frequencies and the corresponding maximum amplitudes. This information can be extracted from the NX NASTRAN 111 solution and should (for the NX 11 solution) be:

Frequency [Hz]	max. Amplitude [mm]
100.1	0.0048
200.2	0.0063
300.3	0.0143
400.4	0.3410
500.5	0.0043
600.6	0.0025
700.7	0.0019
800.8	0.0198
900.9	0.0024
1001	0.0060
...	...

Note: If NX 10 is used, slight variations might be present, due to the older NASTRAN functions.

It can be seen that at 400.4 and at 800.8 Hz there are maxima in the amplitude as was requested in the task. This results in the highest noise pressure at this frequency. Finally, we show the deformation shape and stress distribution for the resonant frequencies 400.4 Hz and 800.8 Hz.

Motor1FT6_assyfem1_sim1 : Solution 1 from Load Recipe 1 Result
Data Source 1 - Empty, Forcing Frequency 5, 400.4 Hz
Displacement - Nodal, Magnitude
Complex Option : At Phase Angle 0.0
Min : 0.215, Max : 0.341, Units = mm
Deformation : Displacement - Nodal Magnitude, Complex Option : Amplitude

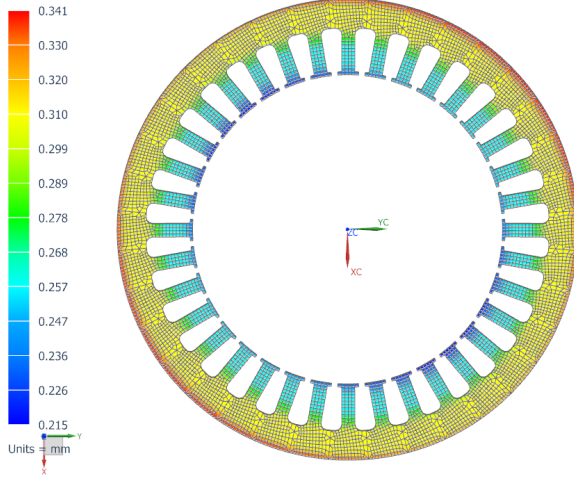

Motor1FT6_assyfem1_sim1 : Solution 1 from Load Recipe 1 Result
Data Source 1 - Empty, Forcing Frequency 9, 800.801 Hz
Displacement - Nodal, Magnitude
Complex Option : At Phase Angle 0.0
Min : 0.00833857, Max : 0.019872, Units = mm
Deformation : Displacement - Nodal Magnitude, Complex Option : Amplitude

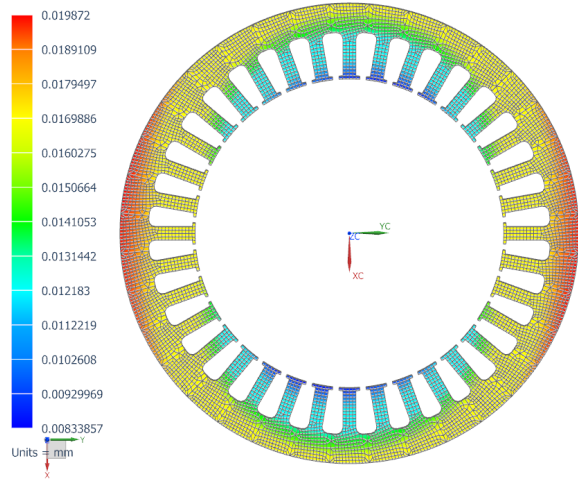

11 References

- 'SantosAnthonisNaclerioGyselinck':
'Multiphysics NVH Modeling: Simulation of a Switched Reluctance Motor for an Electric Vehicle', Fábio L. M. dos Santos, Jan Anthonis, Francesco Naclerio, Johan J. C. Gyselinck, Member, IEEE, Herman Van der Auweraer, Member, IEEE, and Luiz C. S. Góes. IEEE TRANSACTIONS ON INDUSTRIAL ELECTRONICS, VOL. 61, NO. 1, JANUARY 2014.
- 'Eckhardt':
'Grundzüge der elektrischen Maschinen', Hanskarl Eckhardt, Teubner Studienbücher Elektrotechnik/Maschinenbau 1982
- 'Fischer':
'Elektrische Maschinen', Rolf Fischer, Hanser Verlag 14. Auflage
- 'VAC':
'Magnetic Materials, Fundamentals, Products, Properties, Applications', Rainer Hilzinger, Werner Rodewald, VAC Vacuumschmelze
- 'Kost':
'Numerische Methoden in der Berechnung elektromagnetischer Felder', Arnulf Kost, Springer-Lehrbuch
- 'Steinmetz':
C. Steinmetz, On the law of hysteresis (originally published in 1892), Proceedings of the IEEE, vol 72, no. 2, pp. 197...221, 1984